

Harry Potter

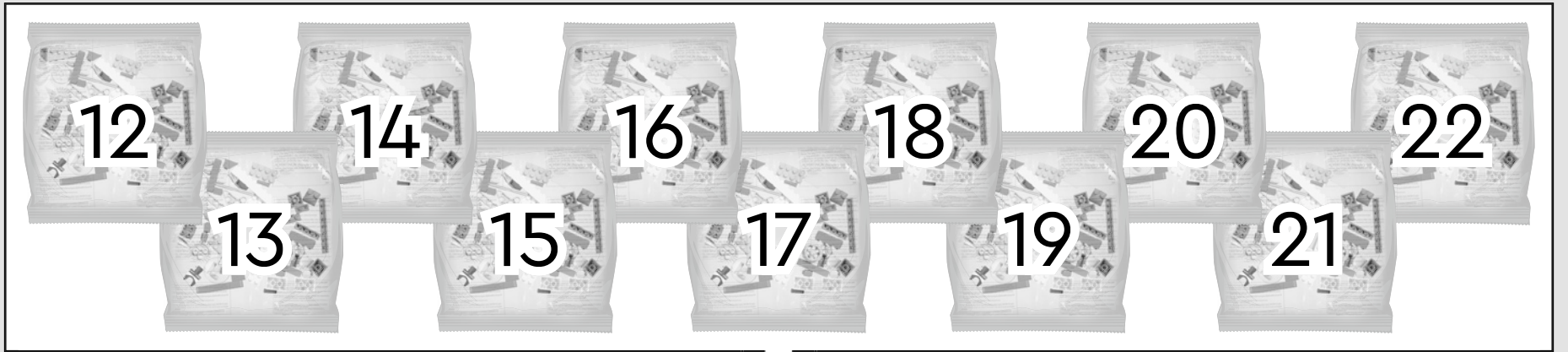

WIZARDING
WORLD





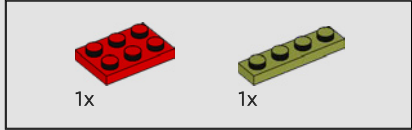
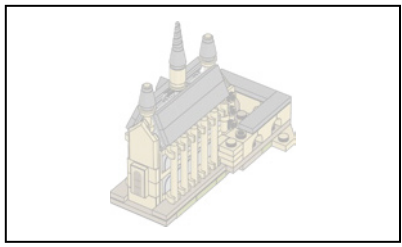

309

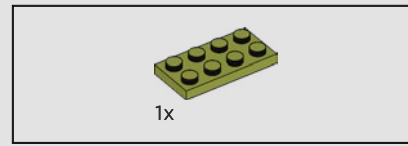
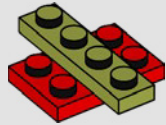

310

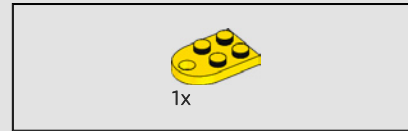
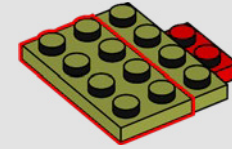

311

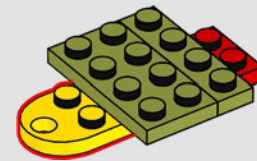

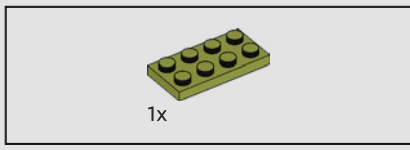

312

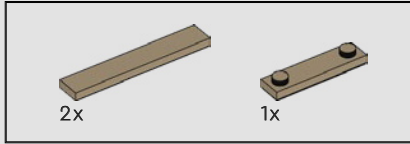
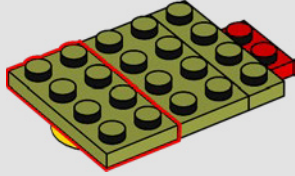

313

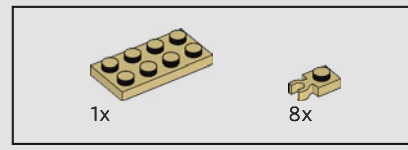
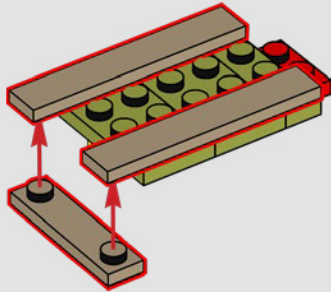

314

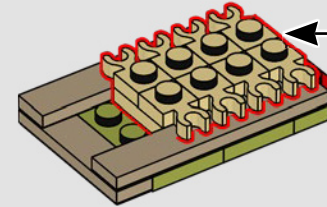
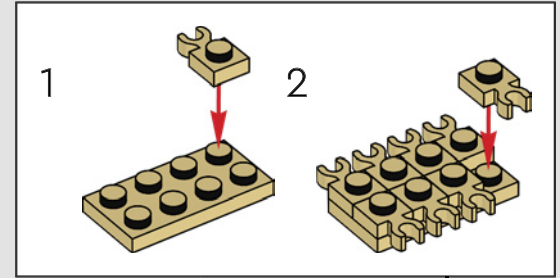

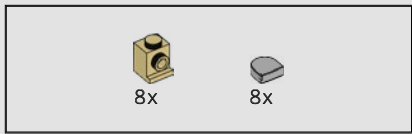

315

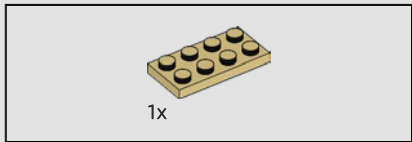
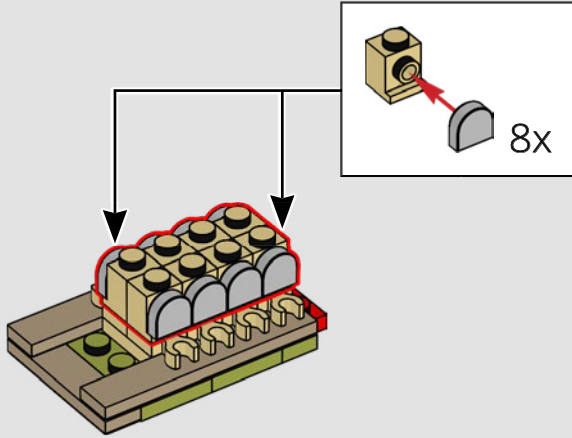

316

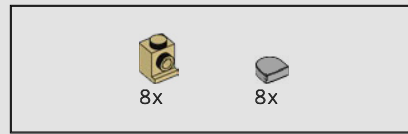
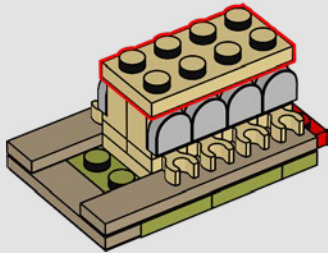

317

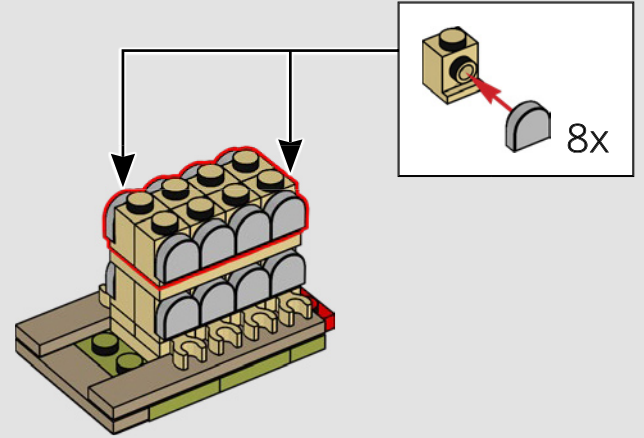

318

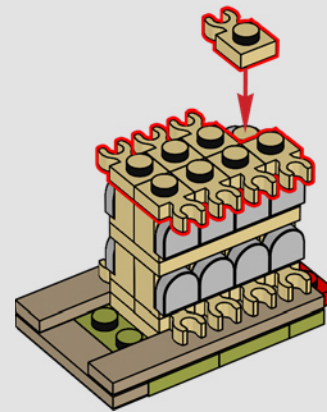

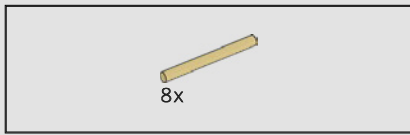

319

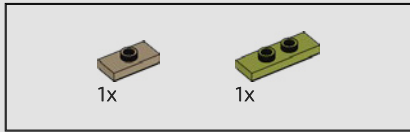
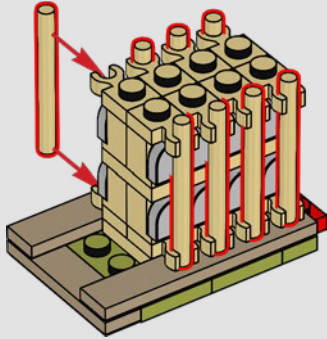

320

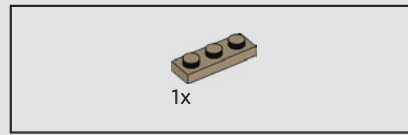
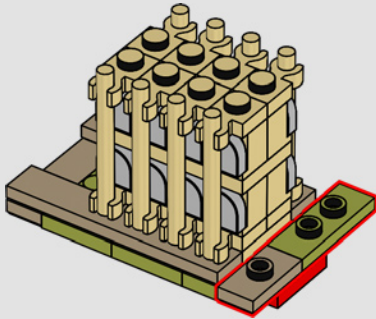

321

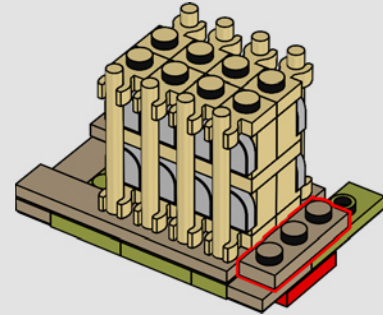

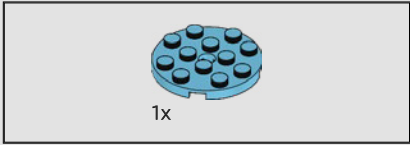
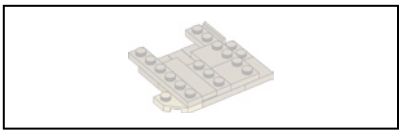

322

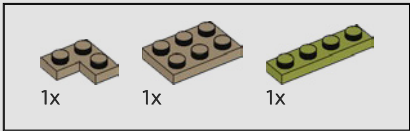
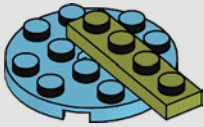

323

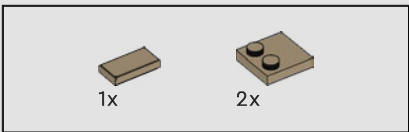
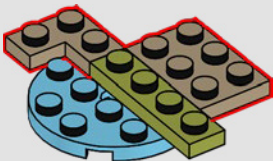

324

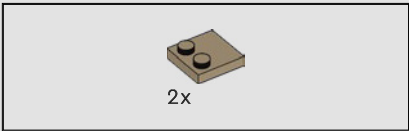
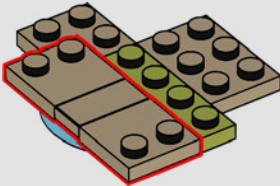

325

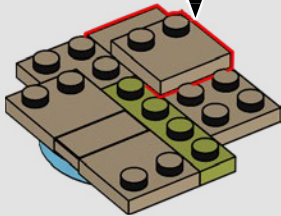
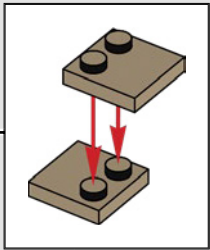

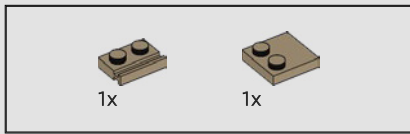

326

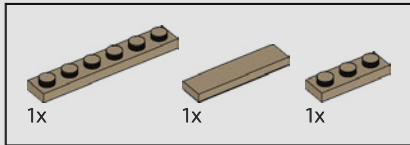
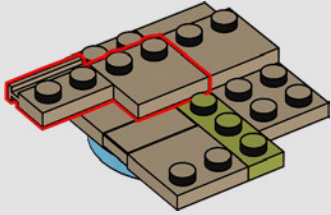

327

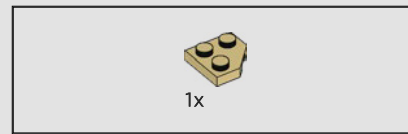
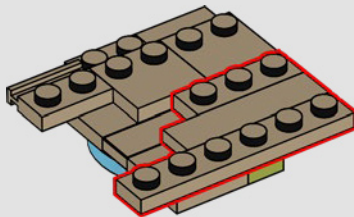

328

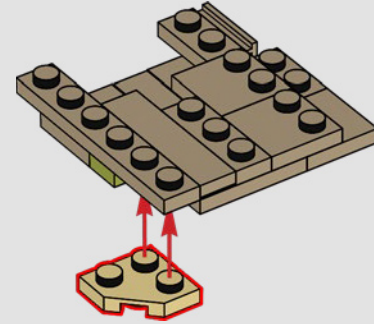
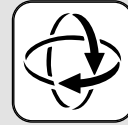

329

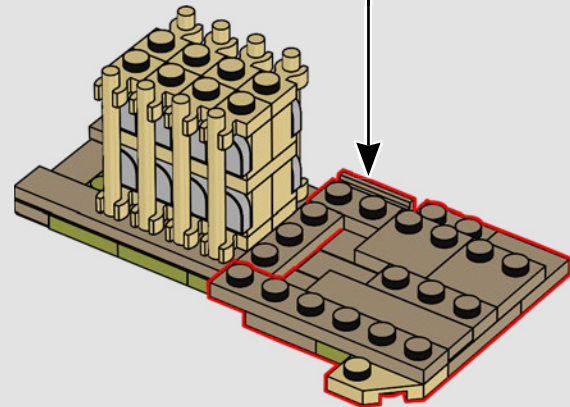

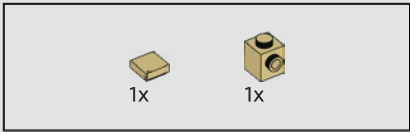

330

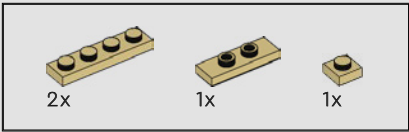
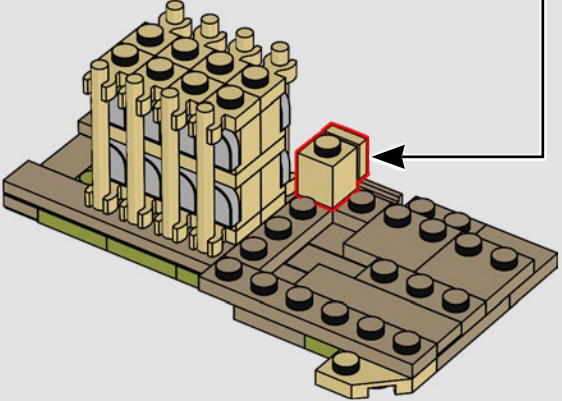
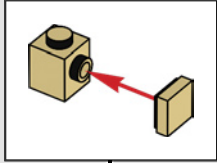

331

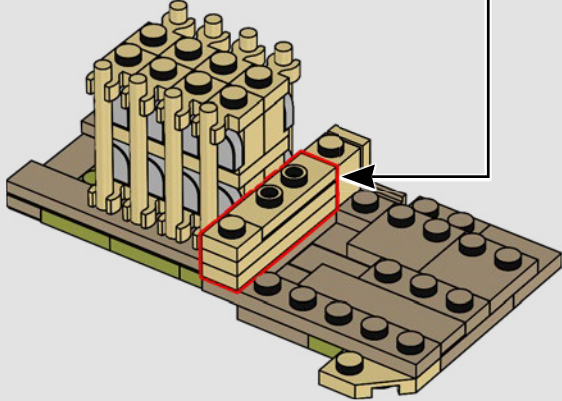
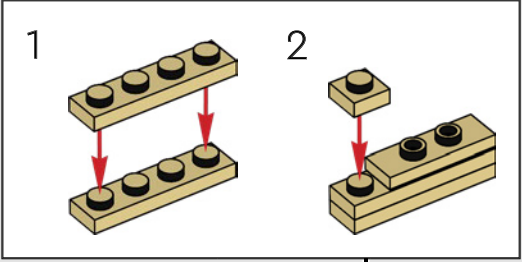

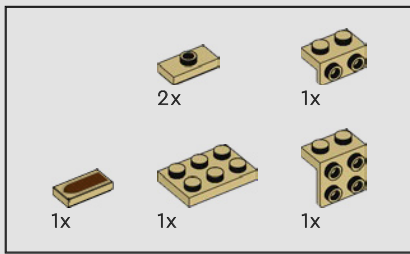

332

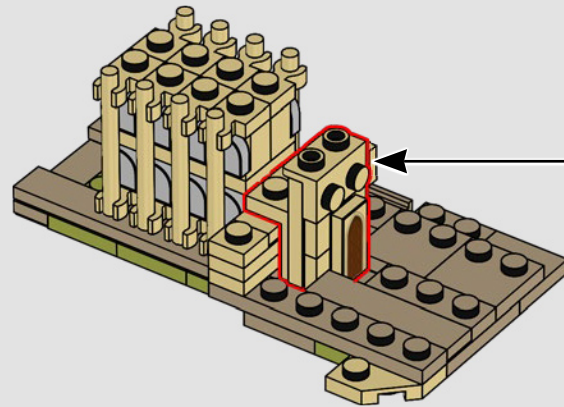
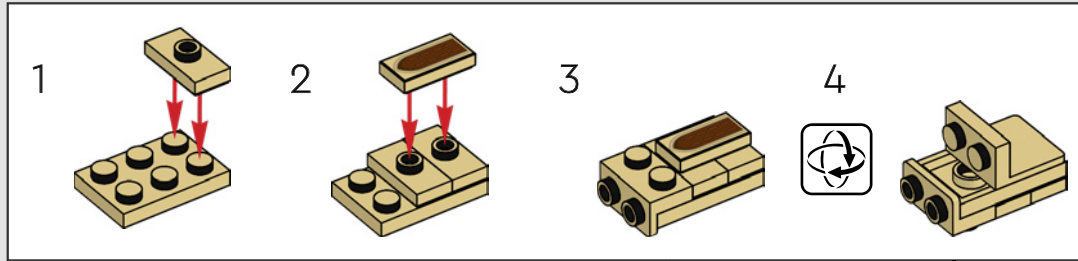

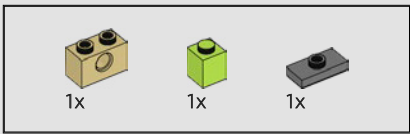

333

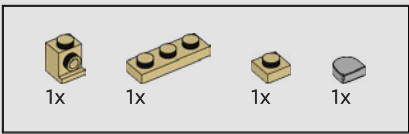
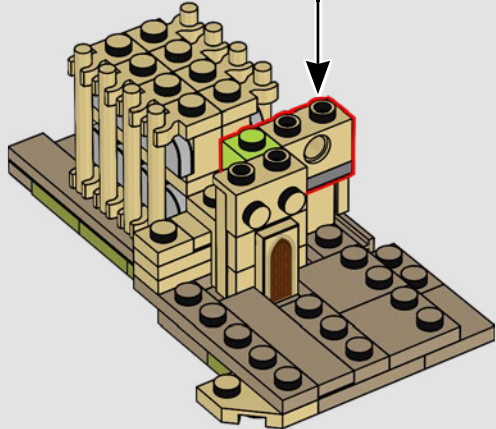
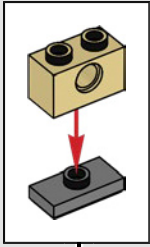

334

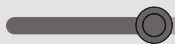
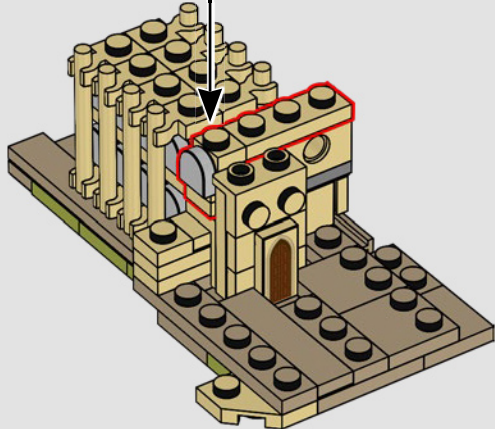
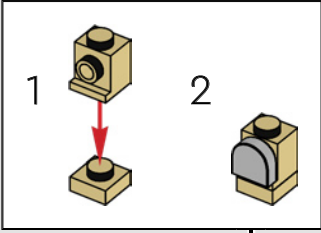



335

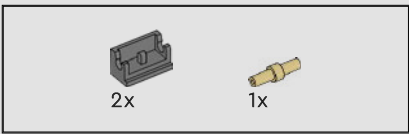
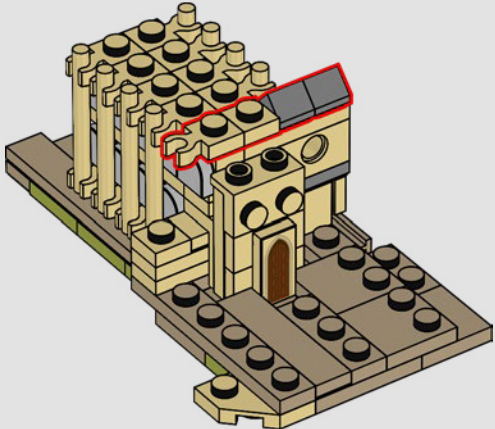

336

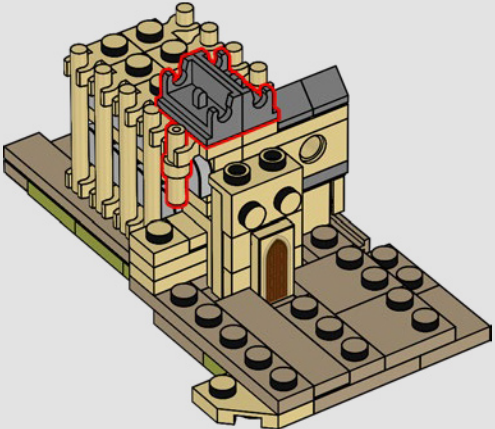

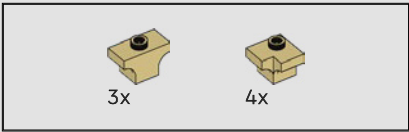

337

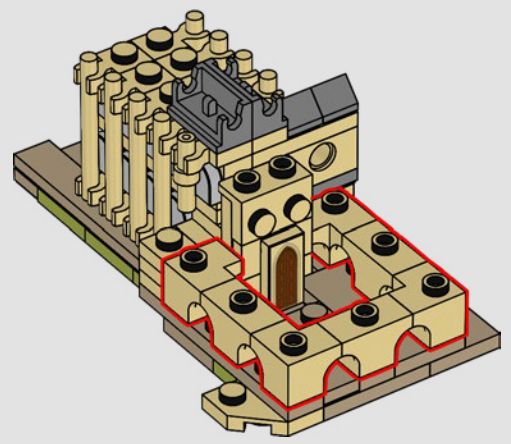

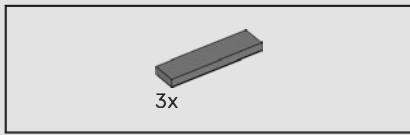

338

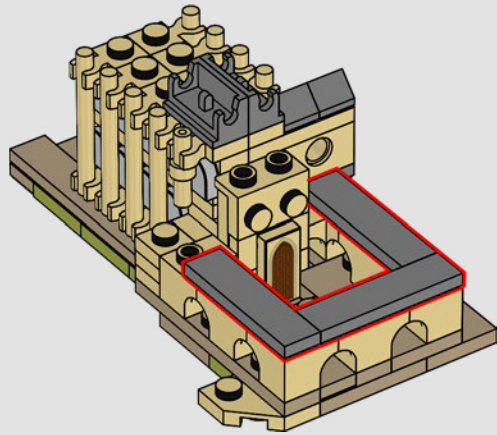

339

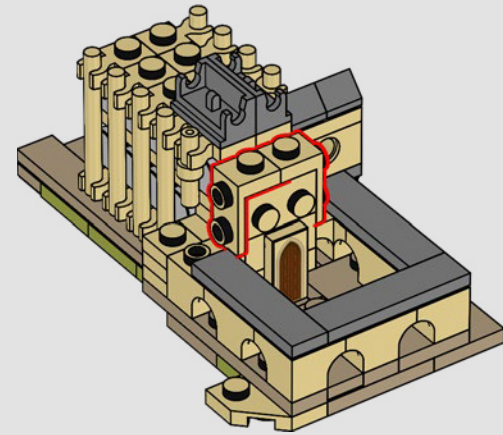



340

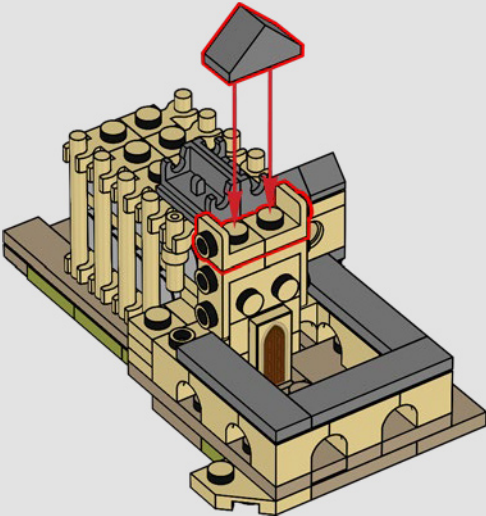

341

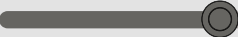
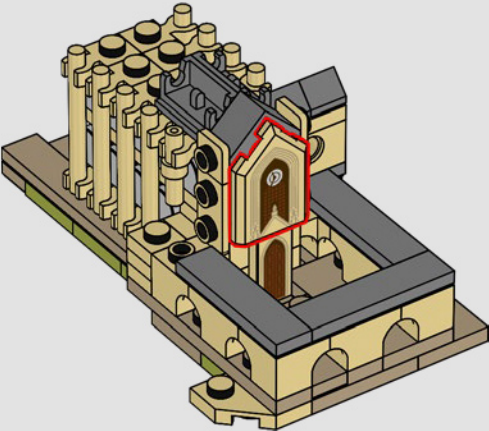

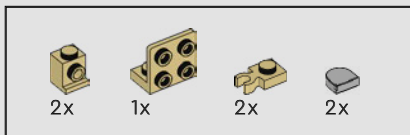

342

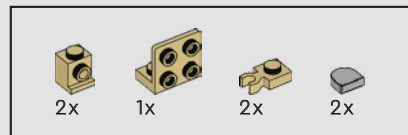
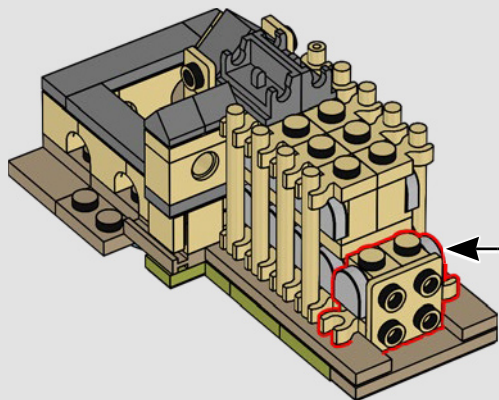
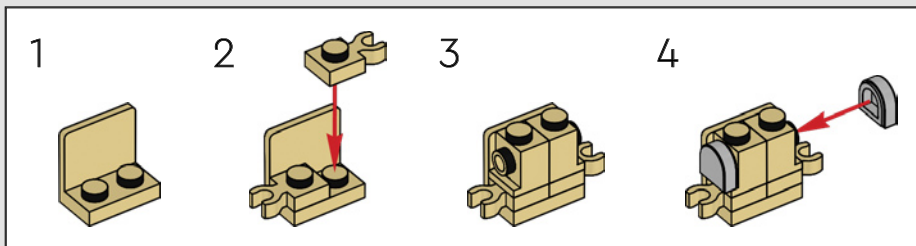

343

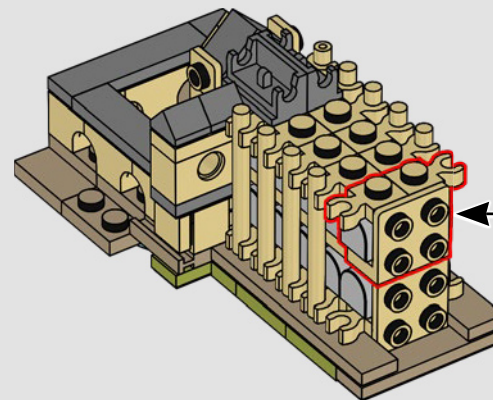
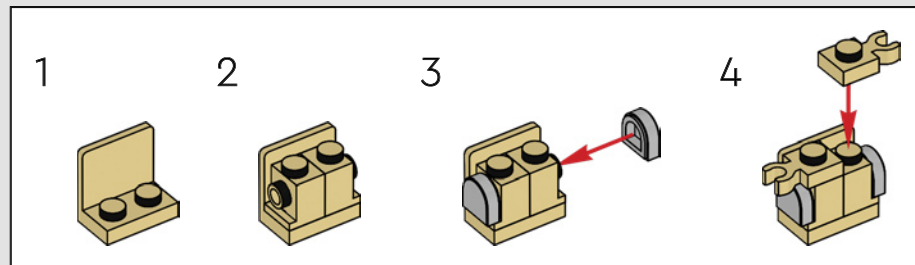

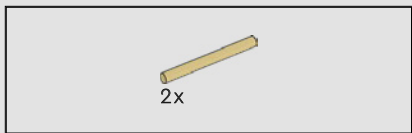

344

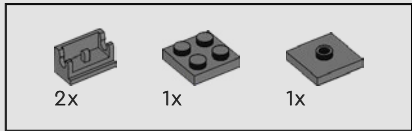
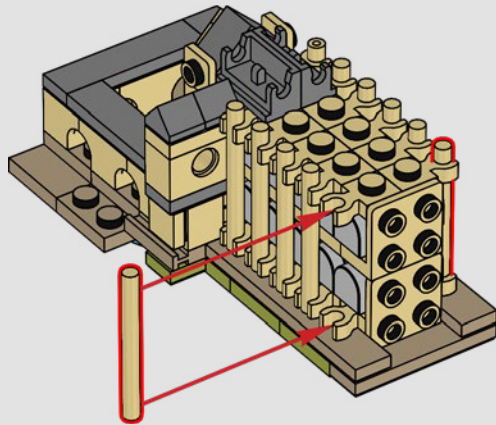

345

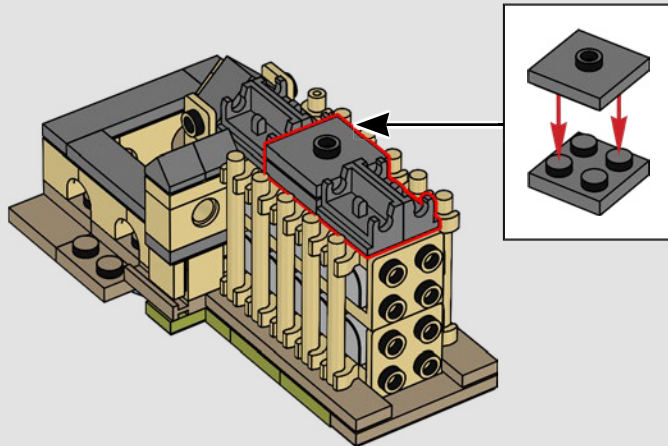

346

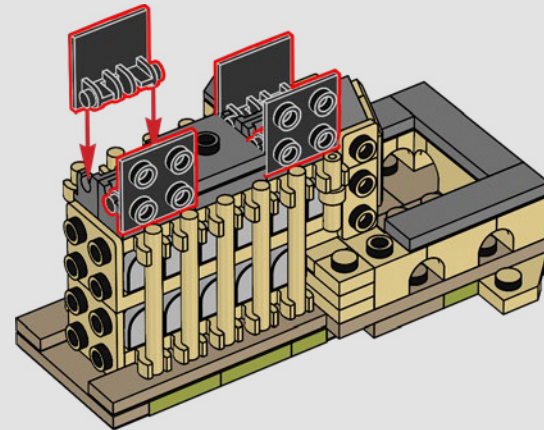

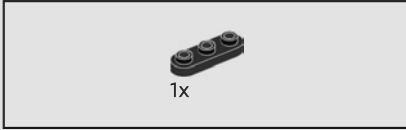
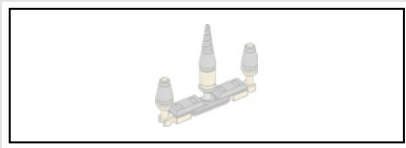

1x

347

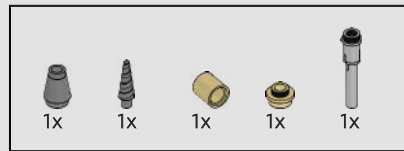

348

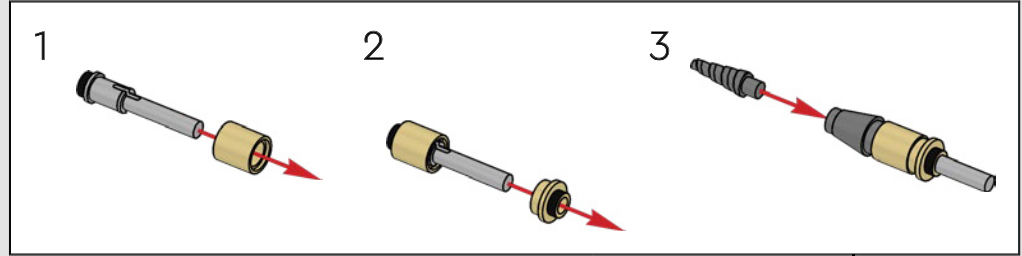



349

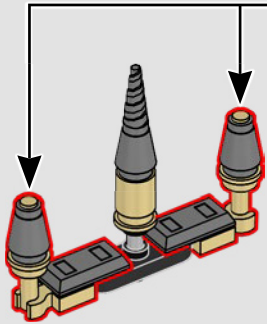
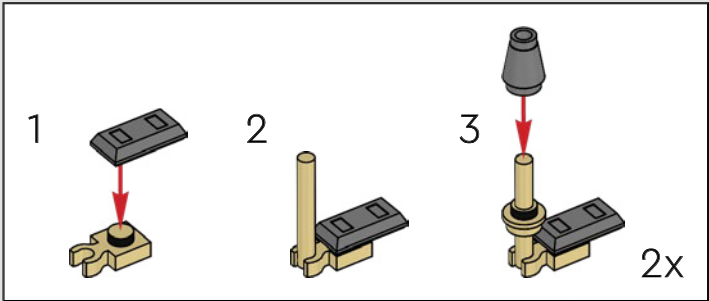

350

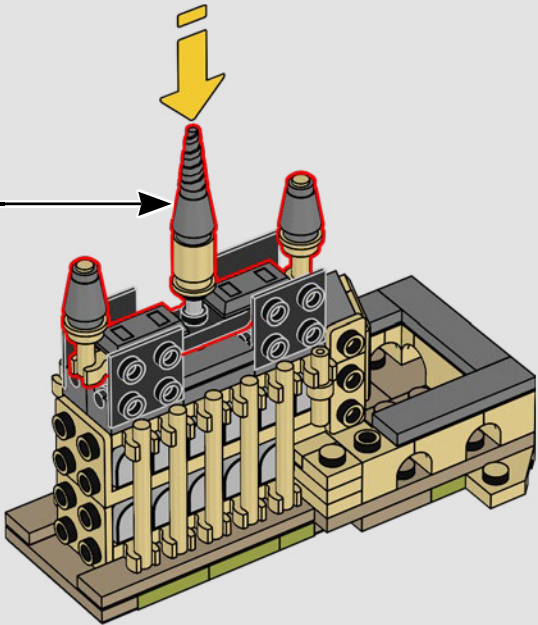

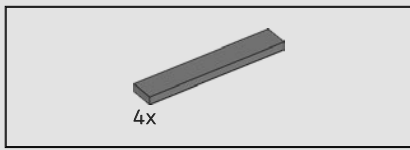

351

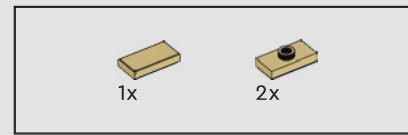
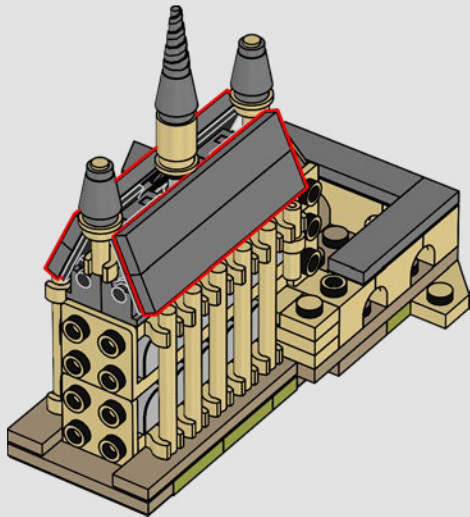

352

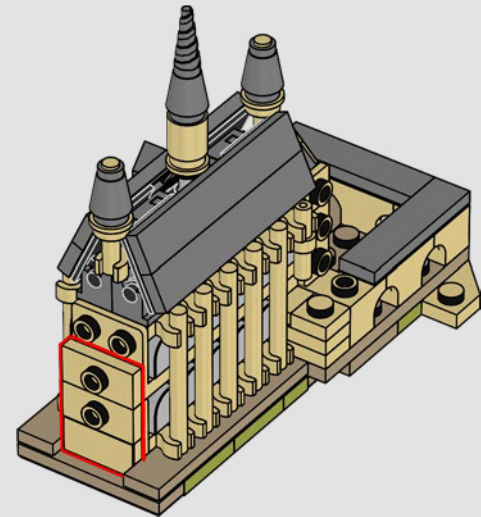

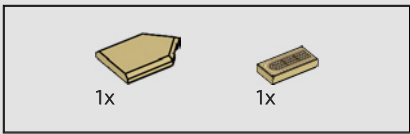

353

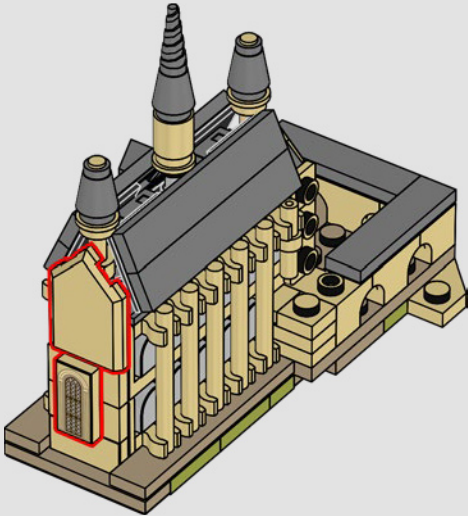

Un charme permet de transformer le plafond de la Grande Salle du château en ciel nocturne.

354

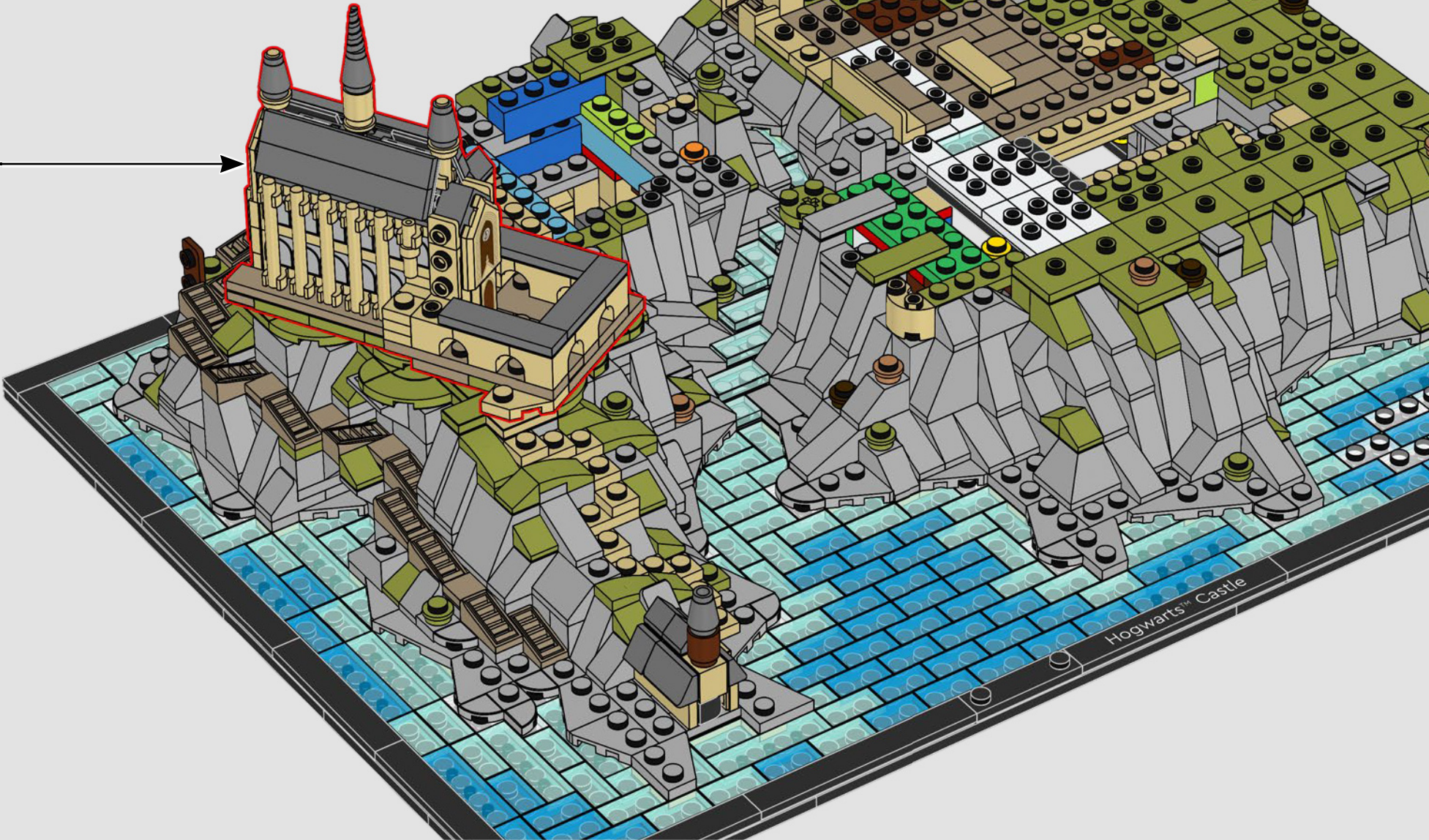

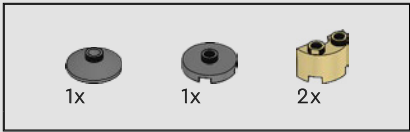

355

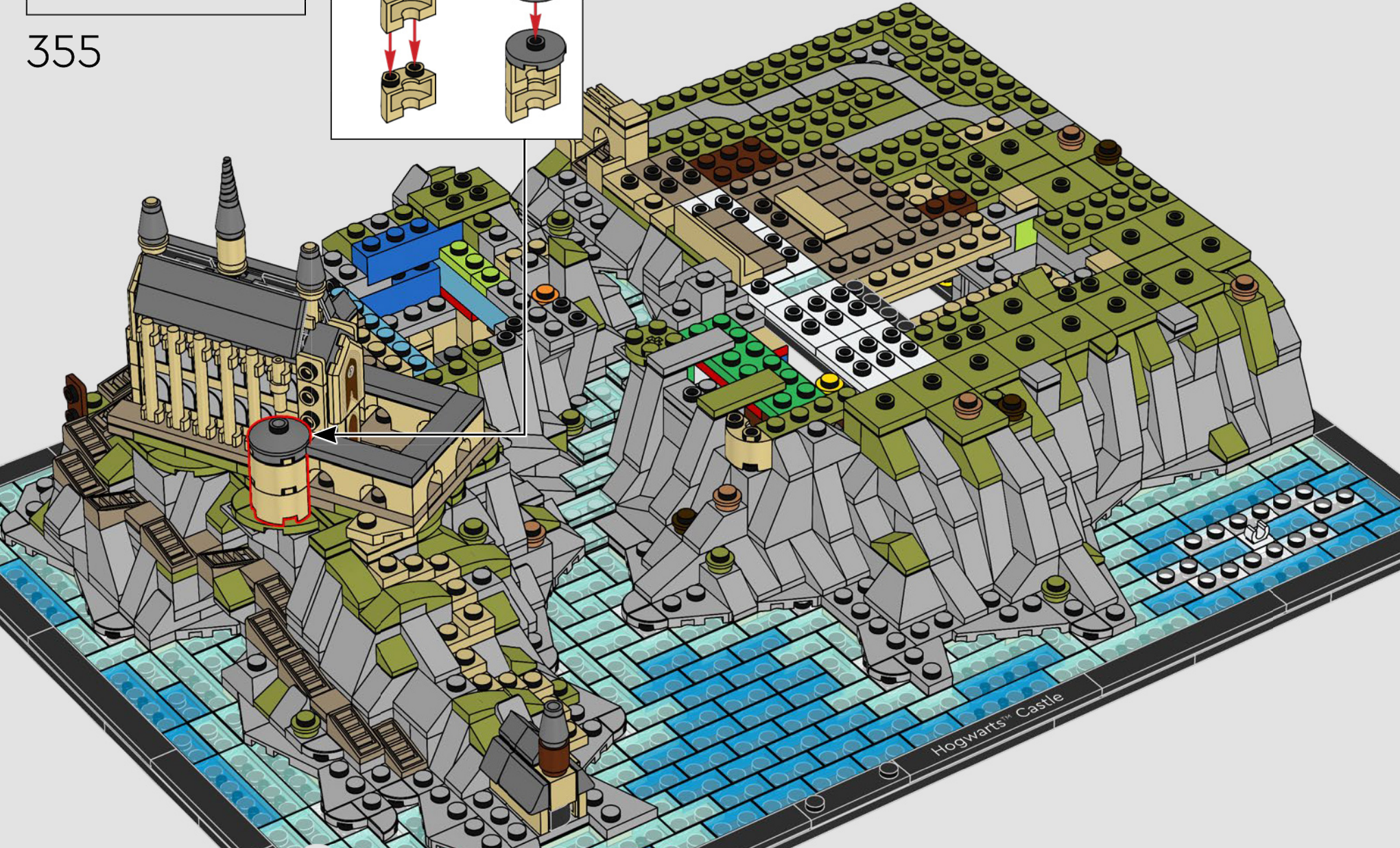
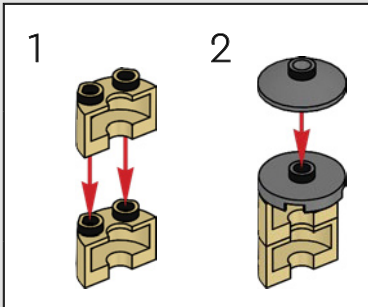

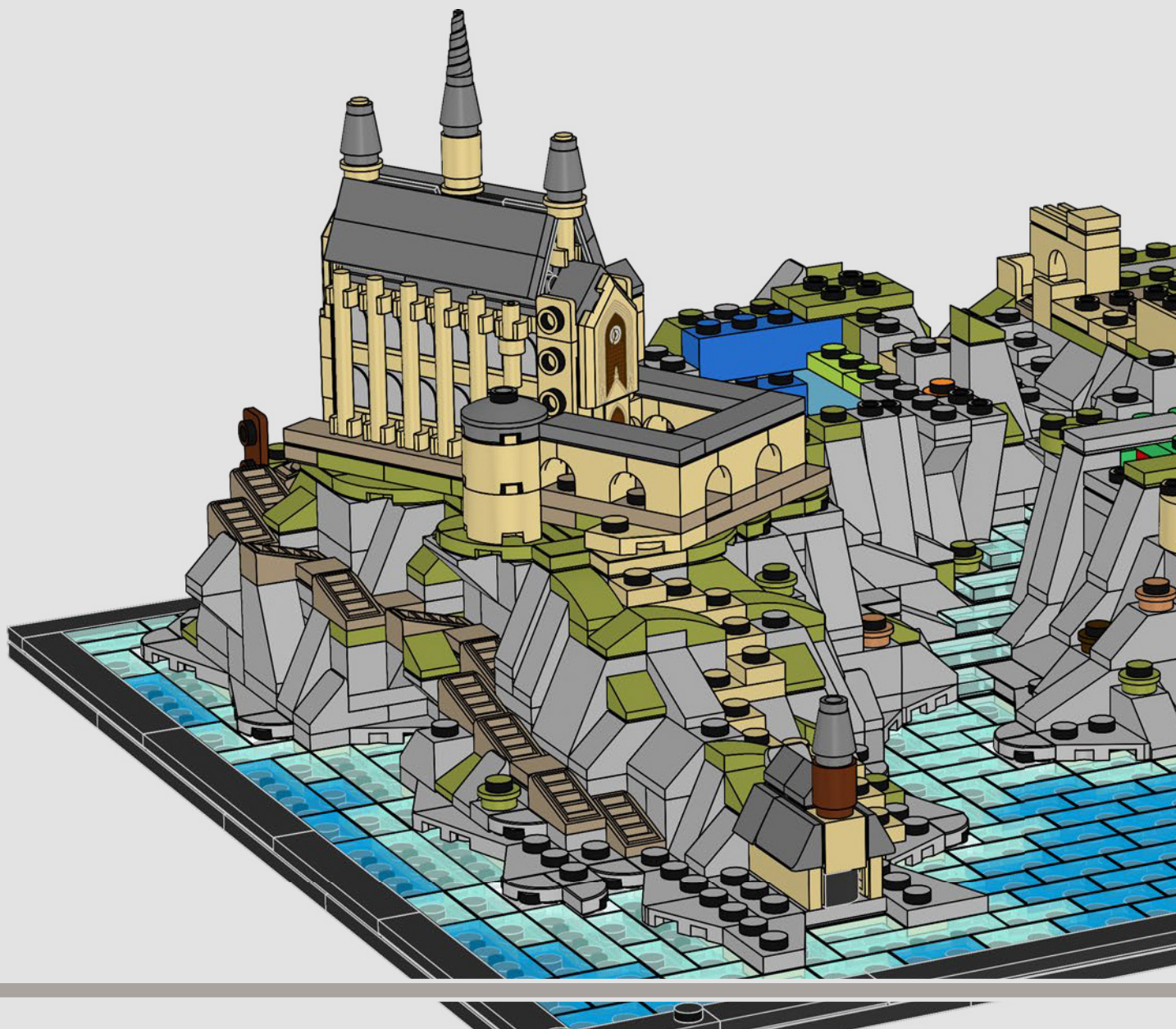

Dès leur arrivée à Poudlard, les élèves de première année découvrent la Grande Salle du château, dans laquelle le Choixpeau désigne la maison dans laquelle ils vont habiter.



356



Les arbres sont faits d'éléments LEGO® représentant du cristal et de la crème glacée (et un peu de magie).

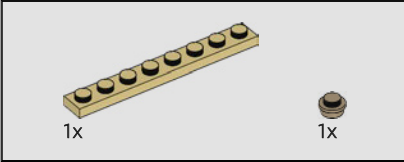
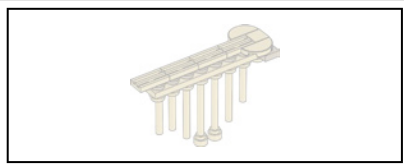

357

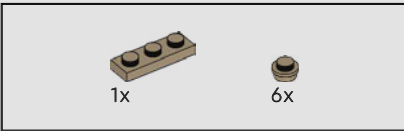
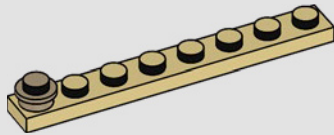

358

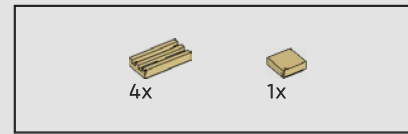
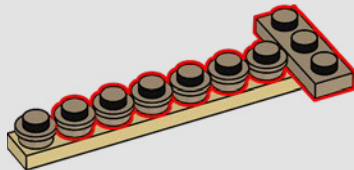

359

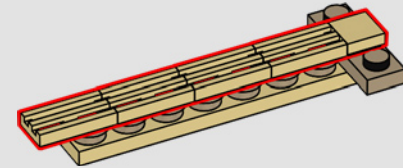

360

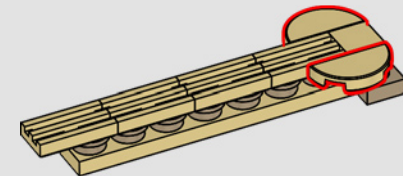

8x

361

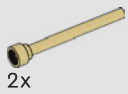
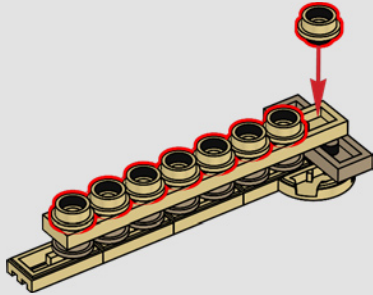

2x

362

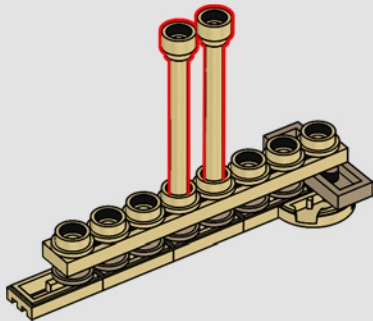

2x

3x

363

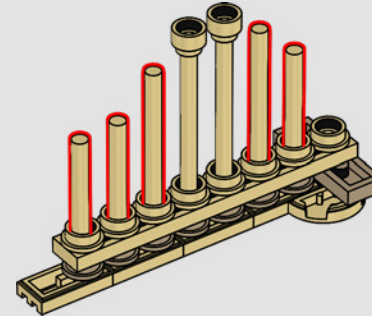

364



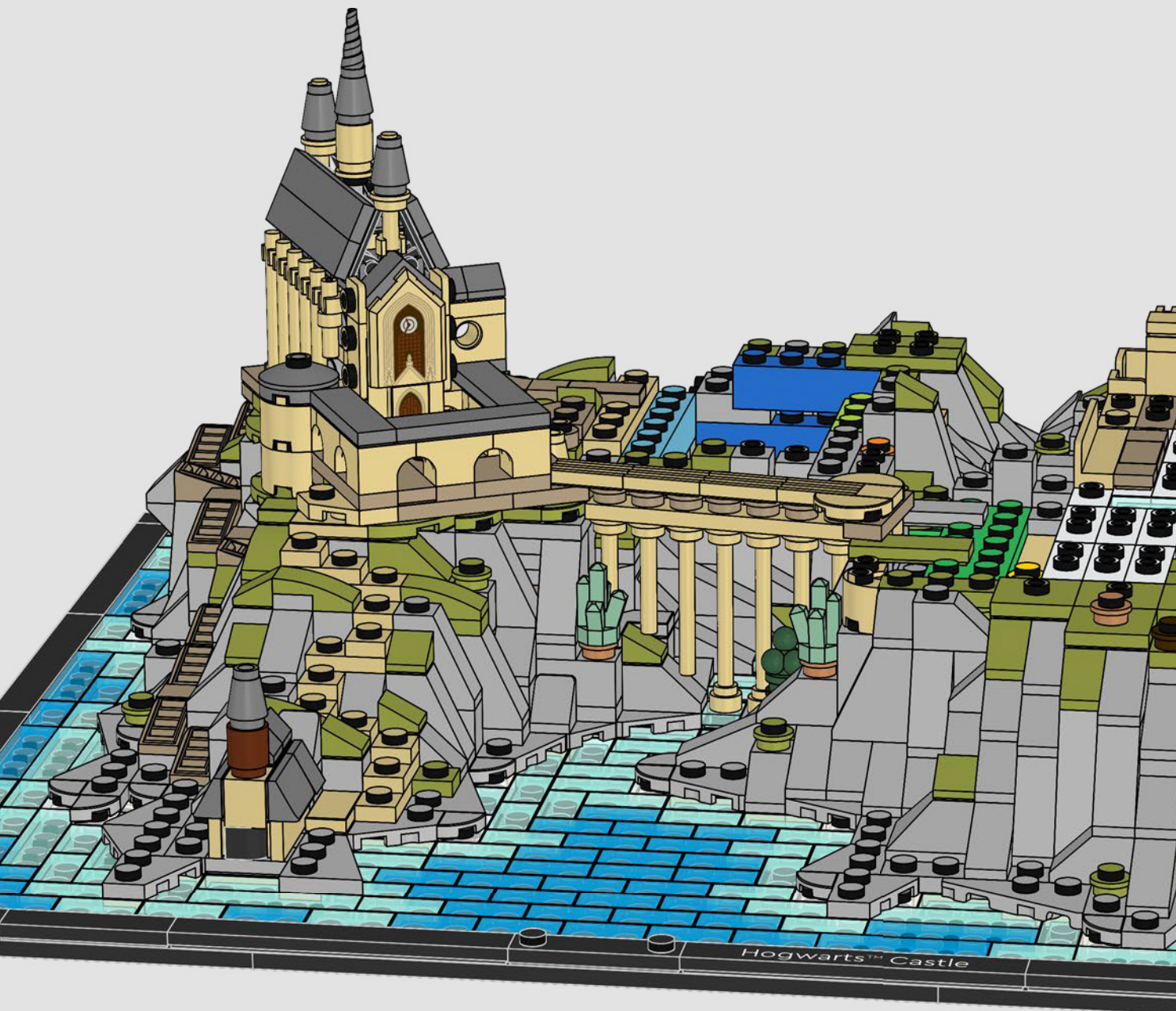

Ouvrage emblématique de la silhouette de Poudlard, le Viaduc joue également un rôle central dans la Bataille de Poudlard : lorsque le professeur McGonagall enchante les armures afin qu'elles fassent leur devoir envers l'école et protègent tous ceux qui s'y trouvent, celles-ci se dirigent vers le pont. Il est également le théâtre d'un moment clé lors de la première tâche du Tournoi des Trois Sorciers, quand le Magyar à pointes s'élançait sous le pont à la poursuite de Harry.





365





2x

366

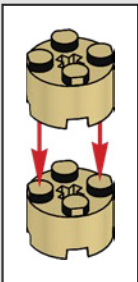
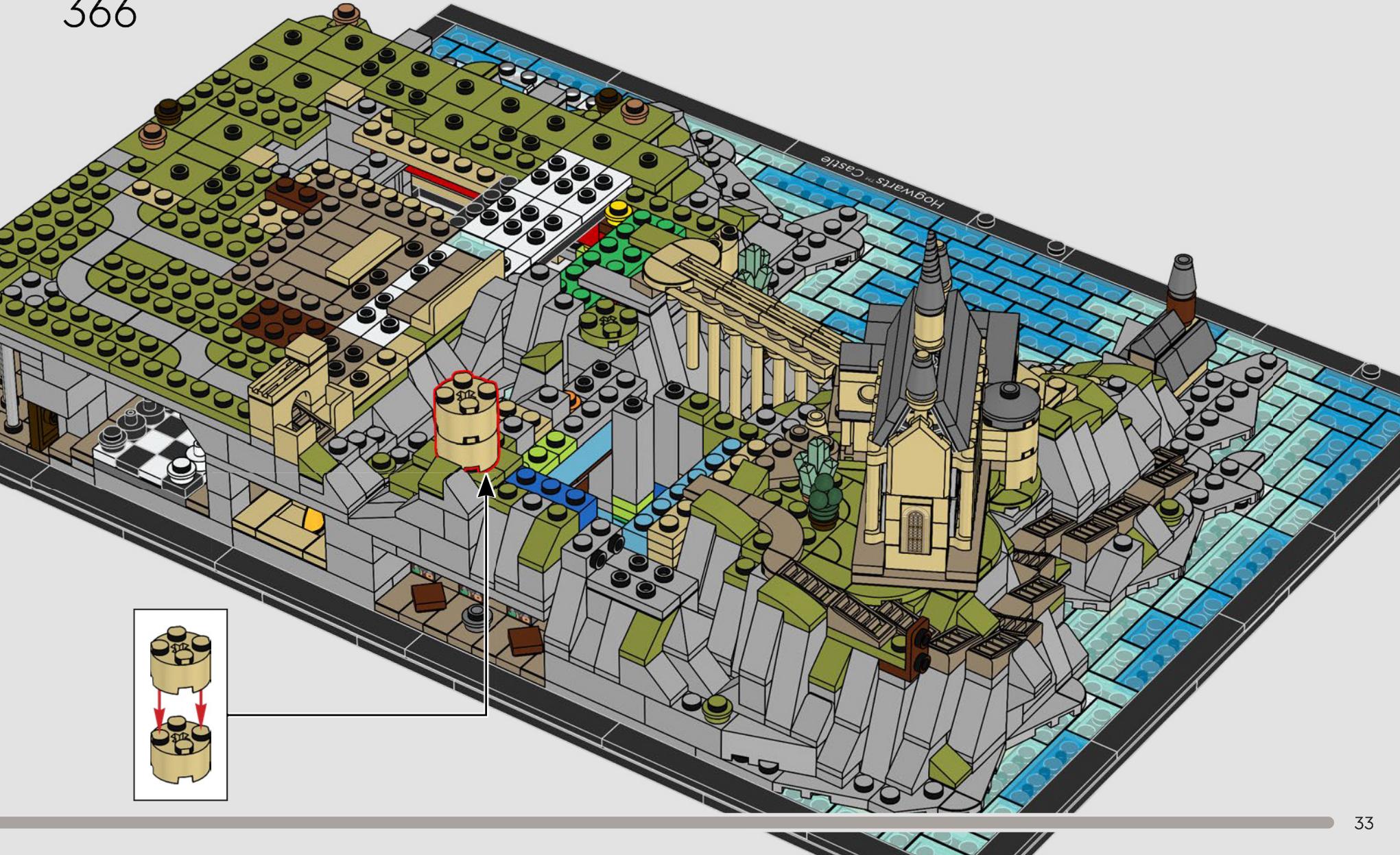

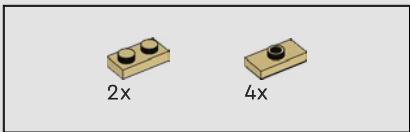

367

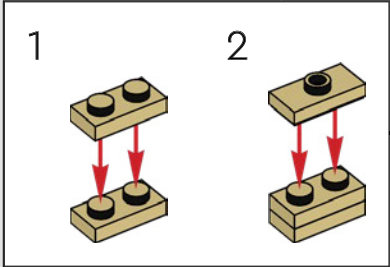
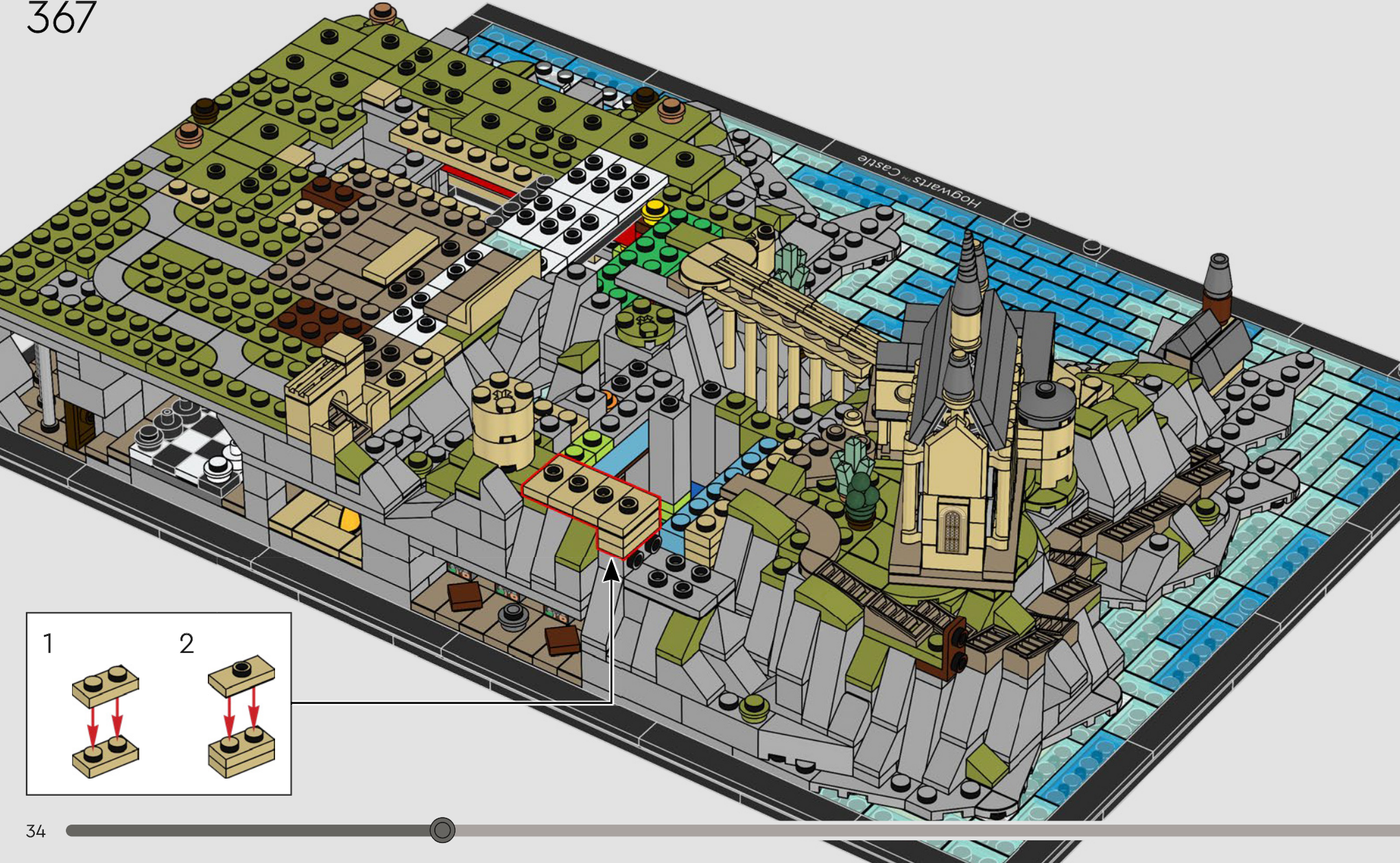

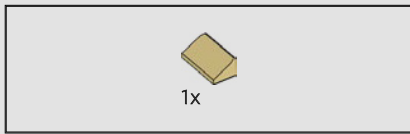

368

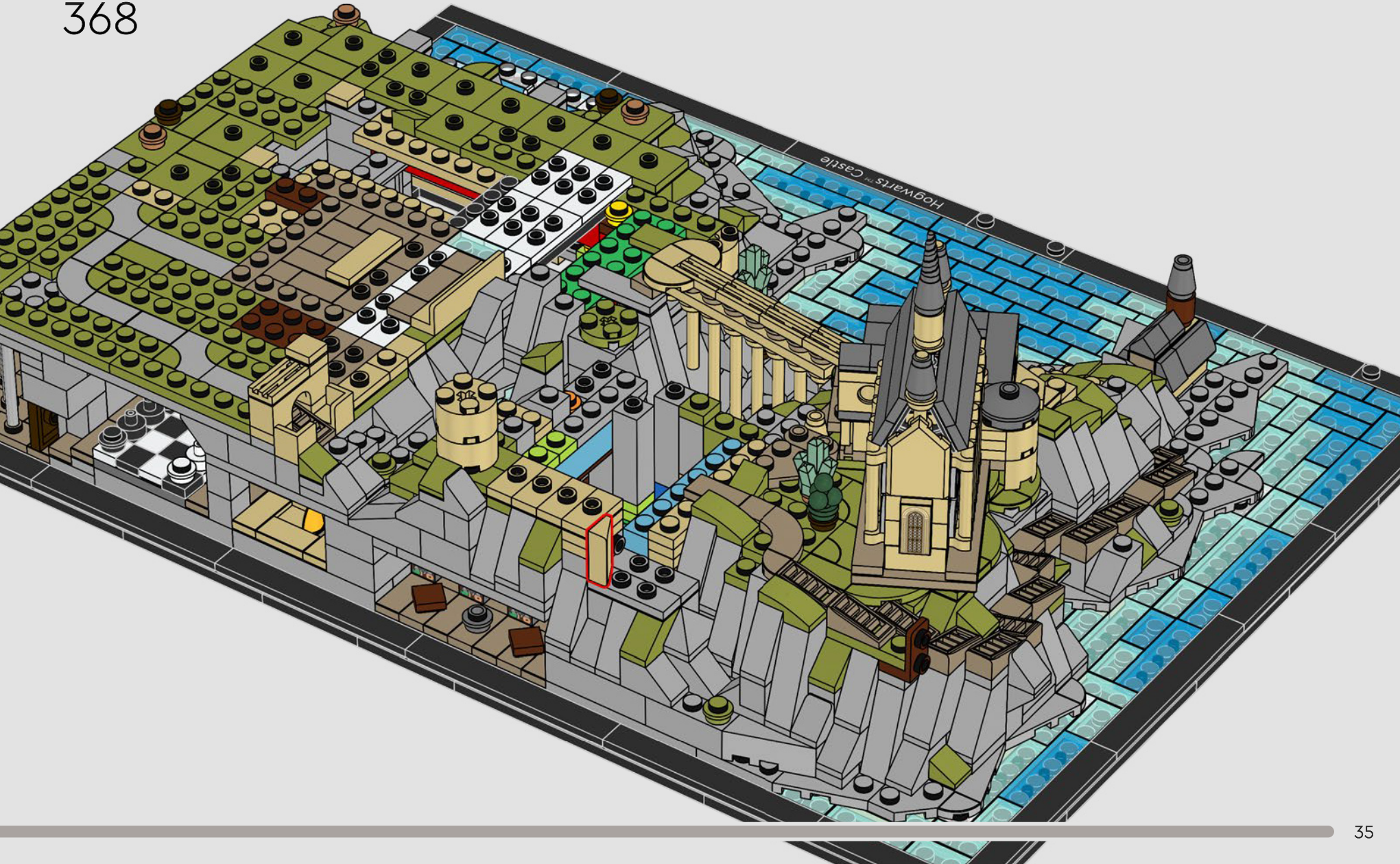

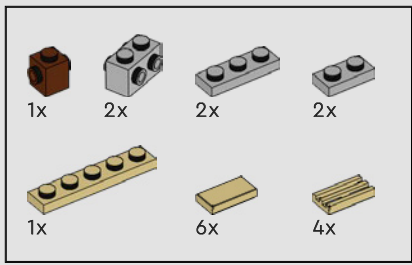

369

1

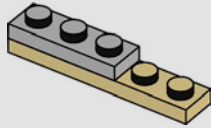

2

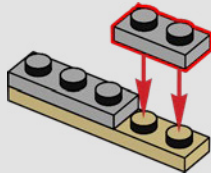

3

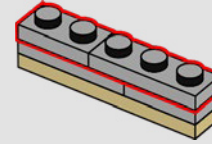

4

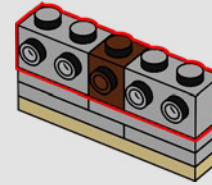

5

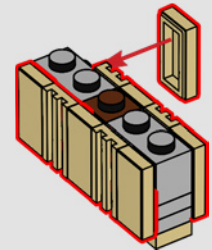

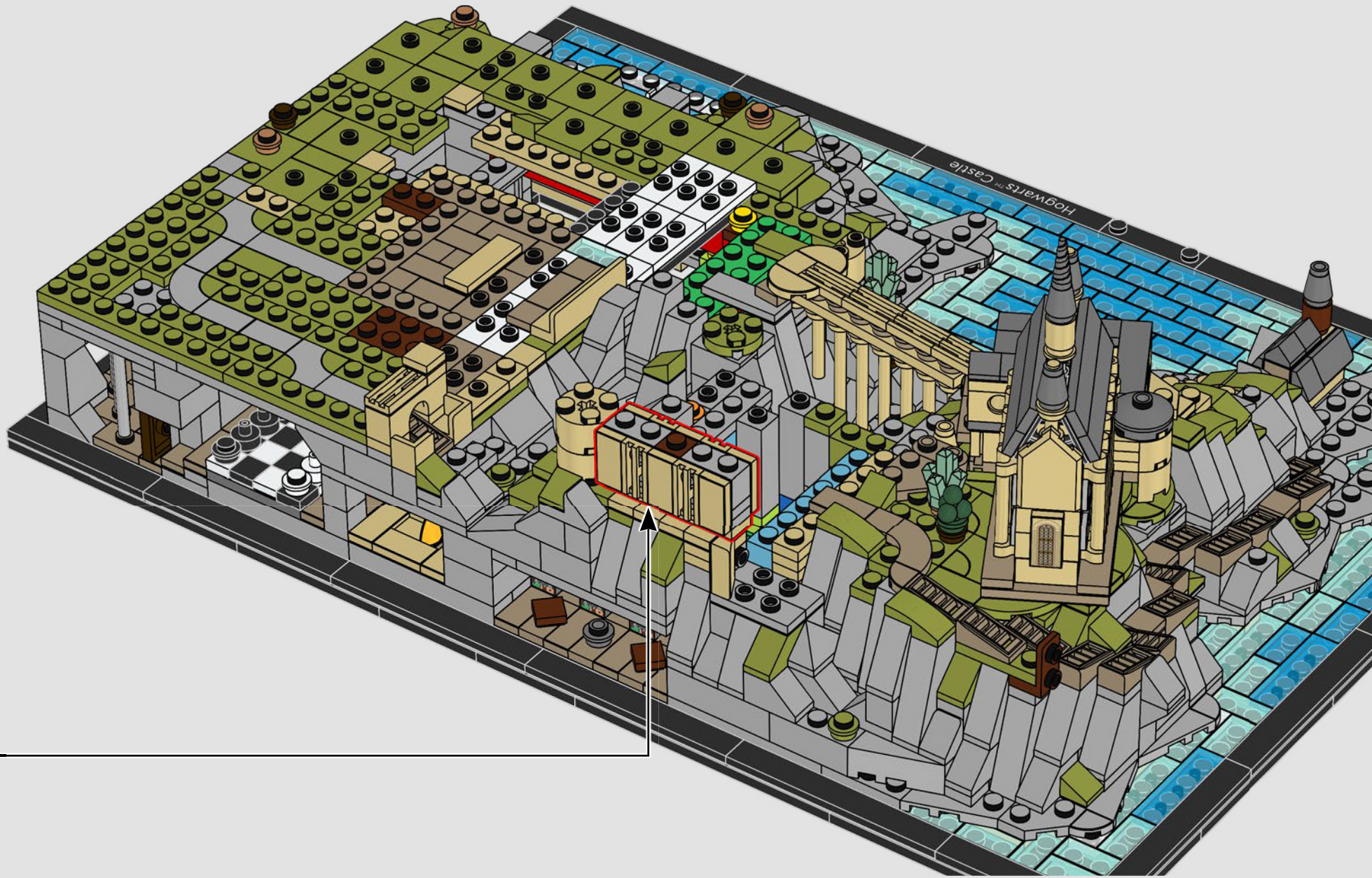

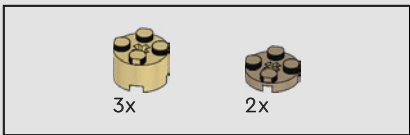

370

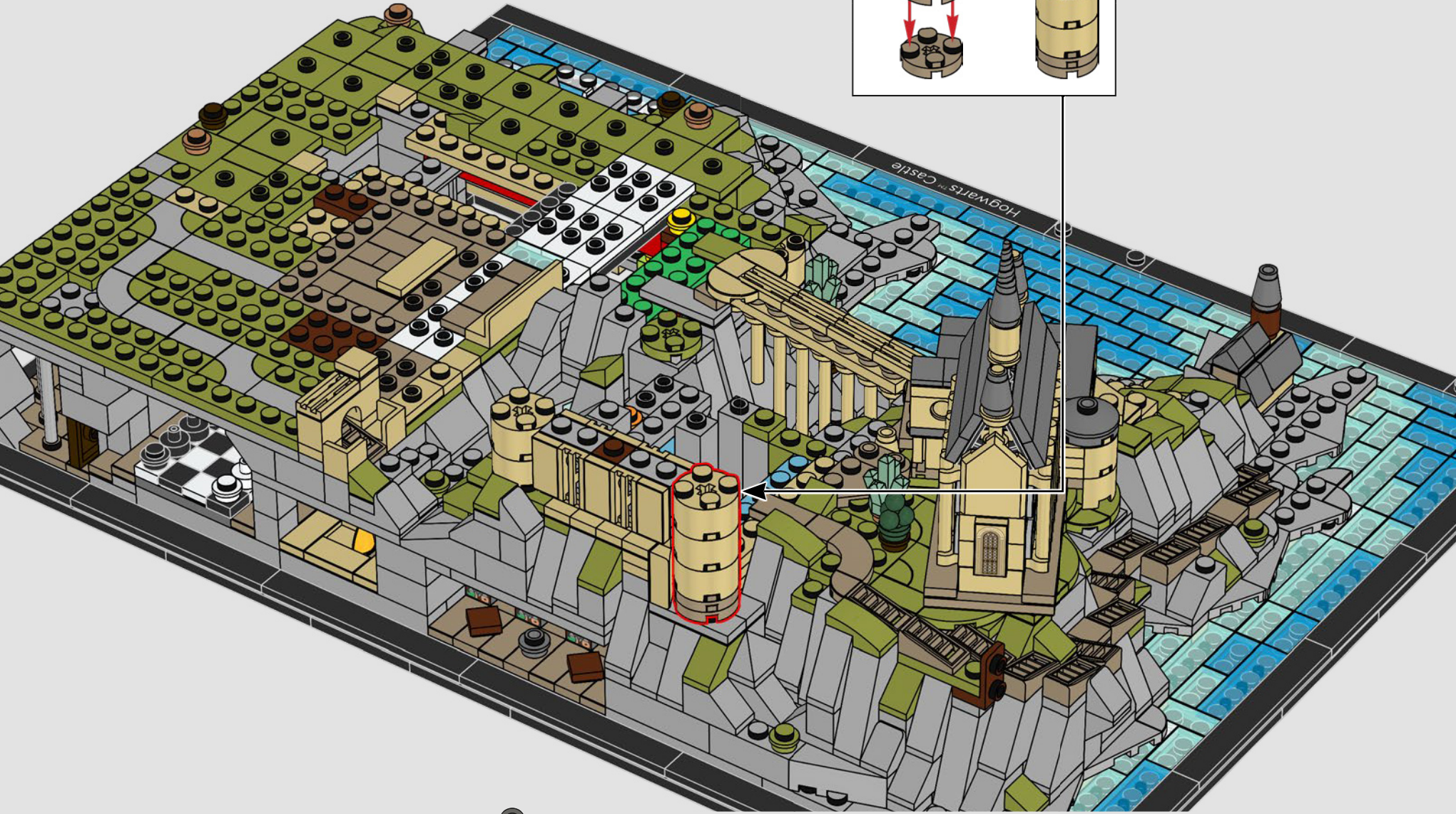
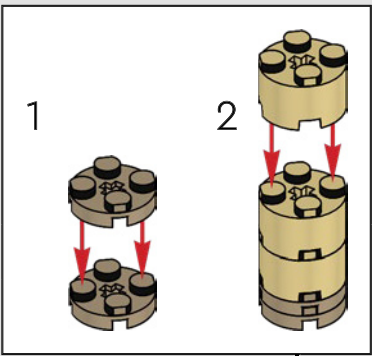

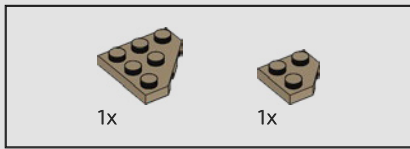

371

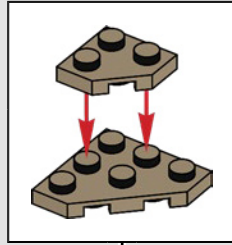

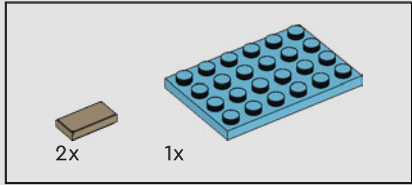
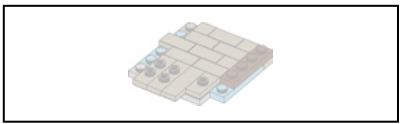

372

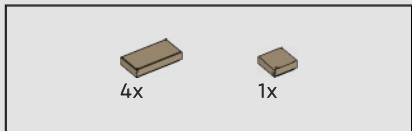
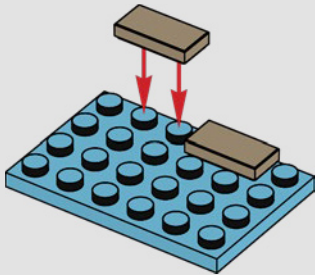

373

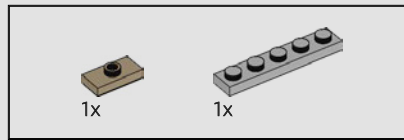
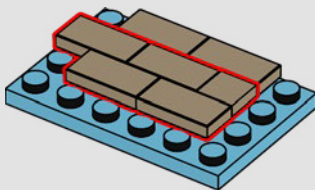

374

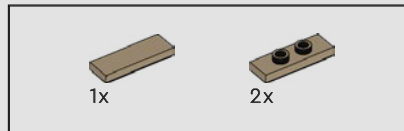
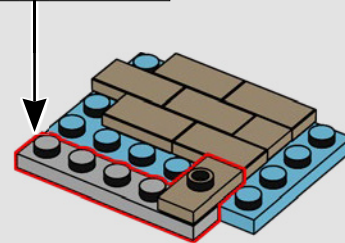
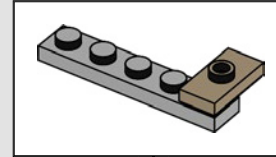

375

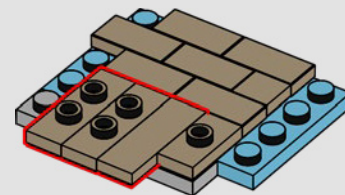

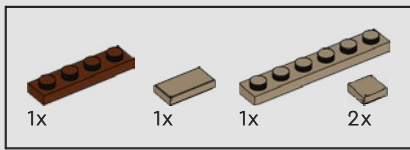

376

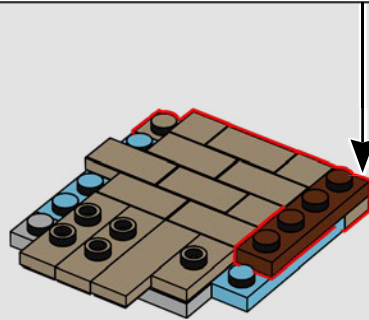
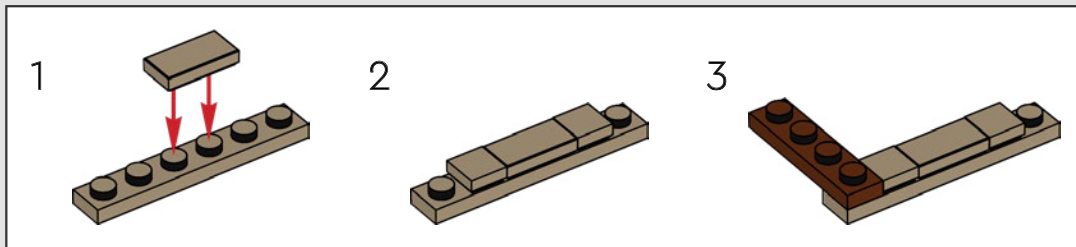

377



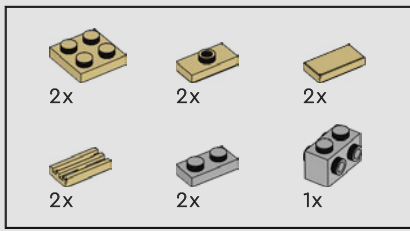

378

1

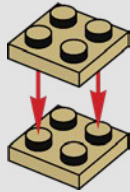

2

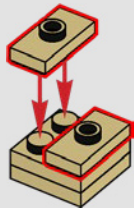

3

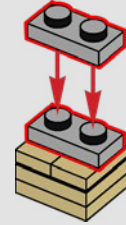

4

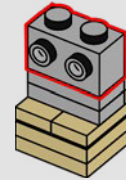

5

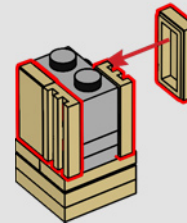



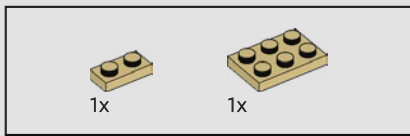

379

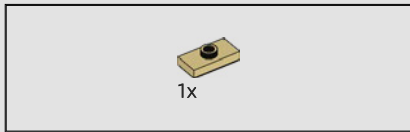
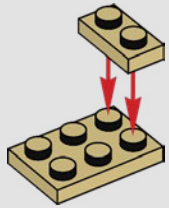

380

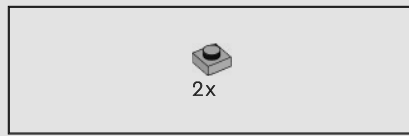
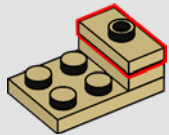

381

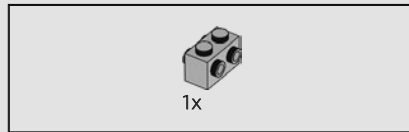
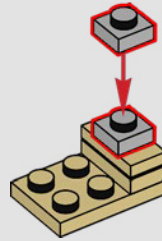

382

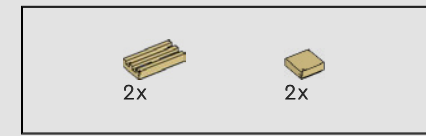
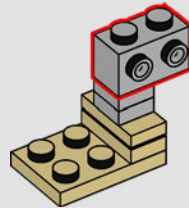

383

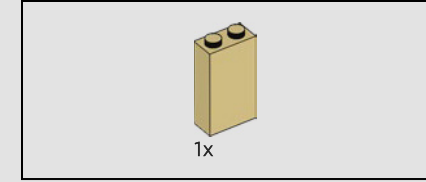
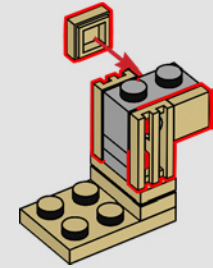

384

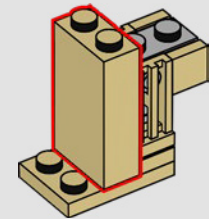

385

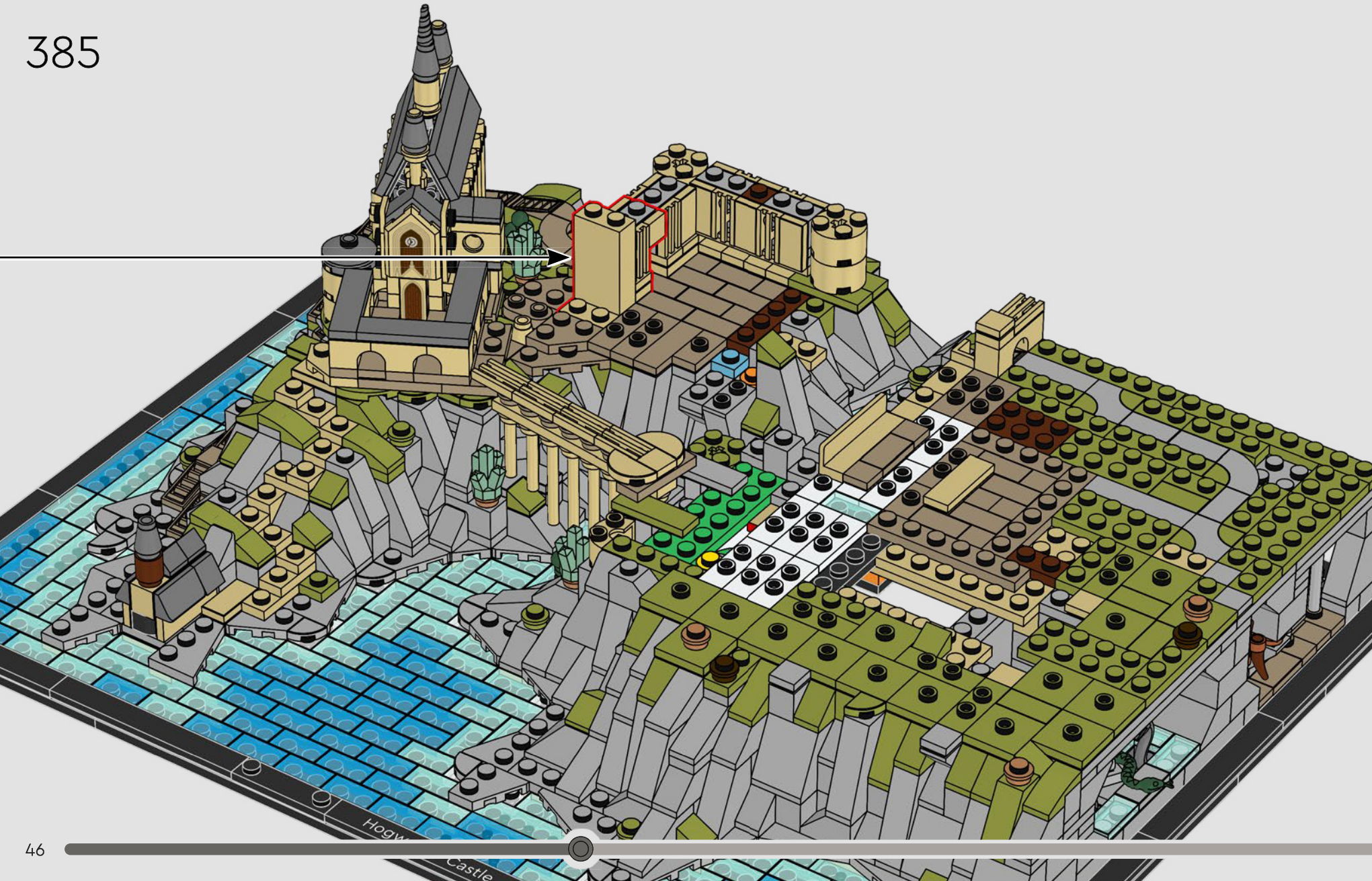

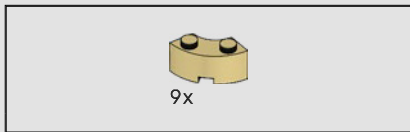

386

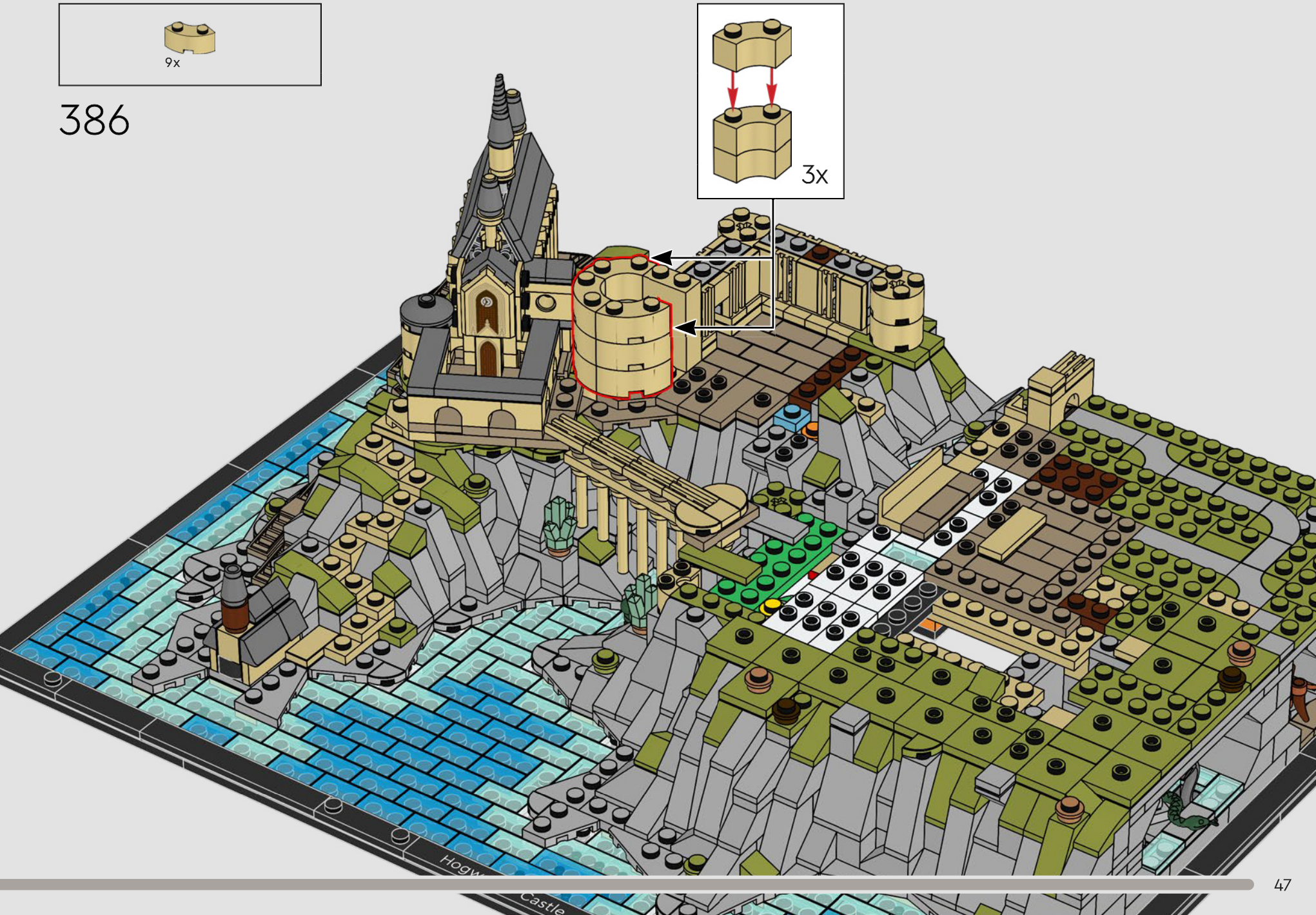
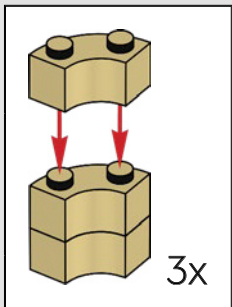

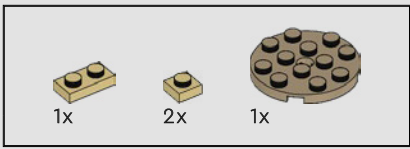

387

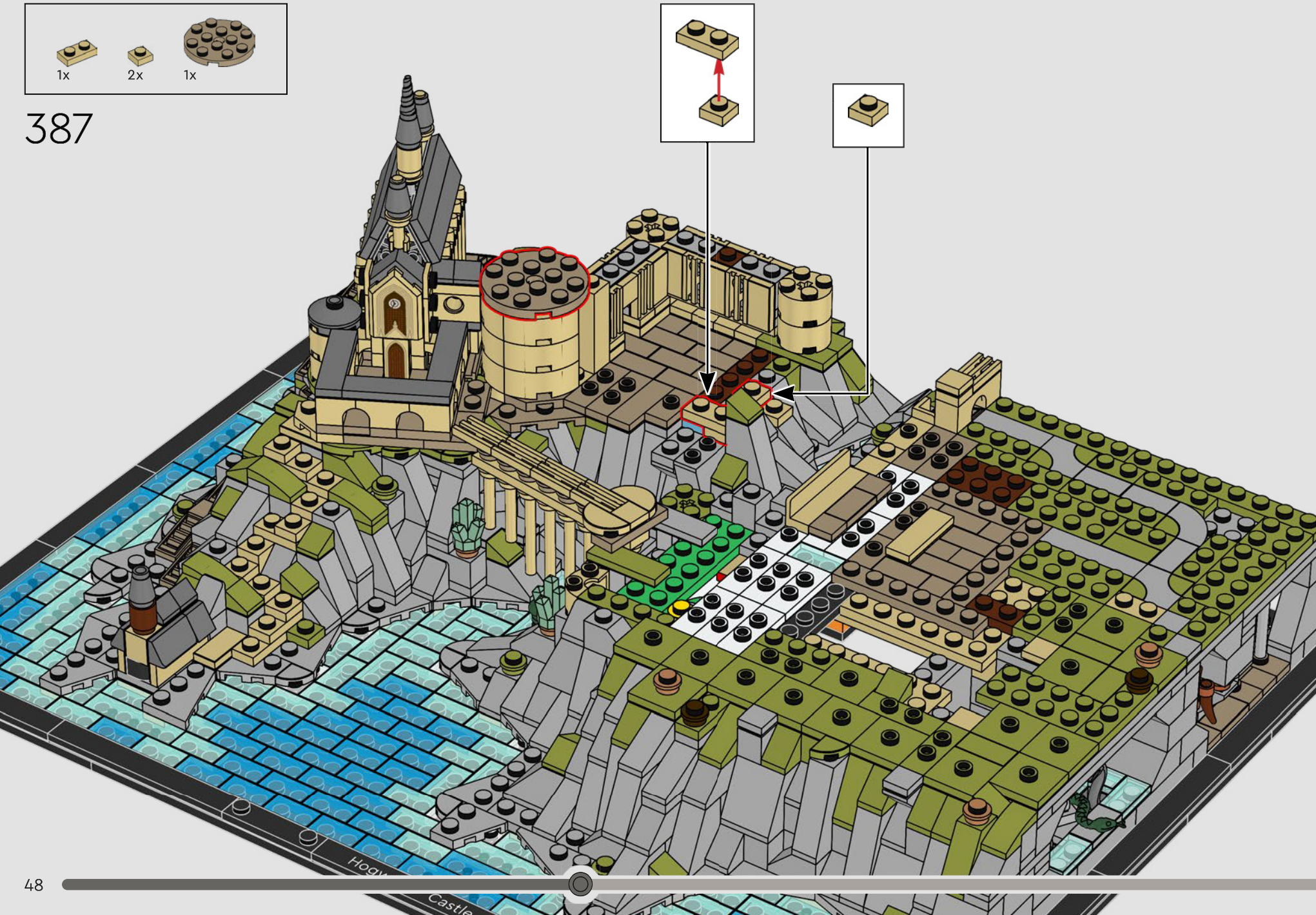
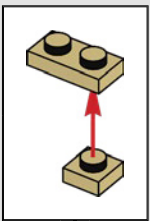

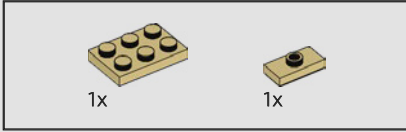
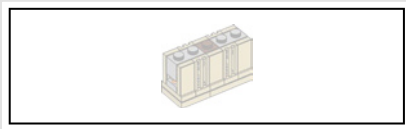

388

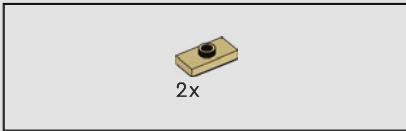
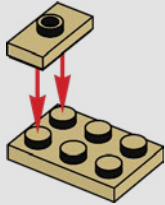

389

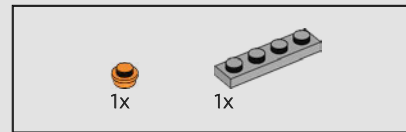
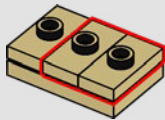

390

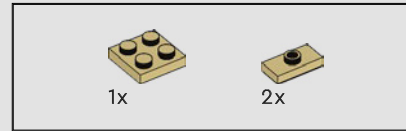
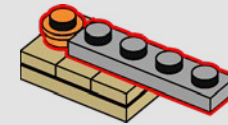

391

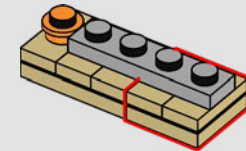
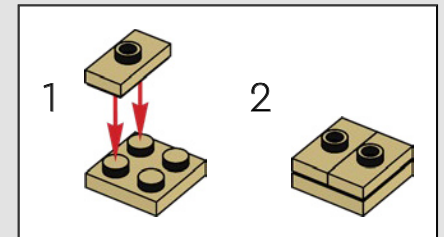

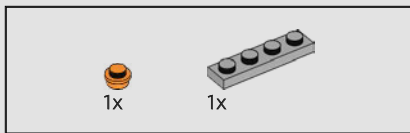

392

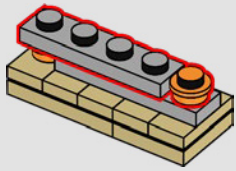

393

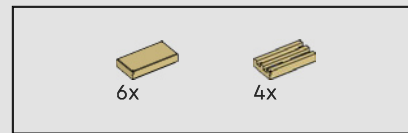
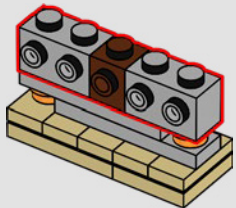

394

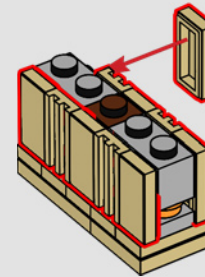

395

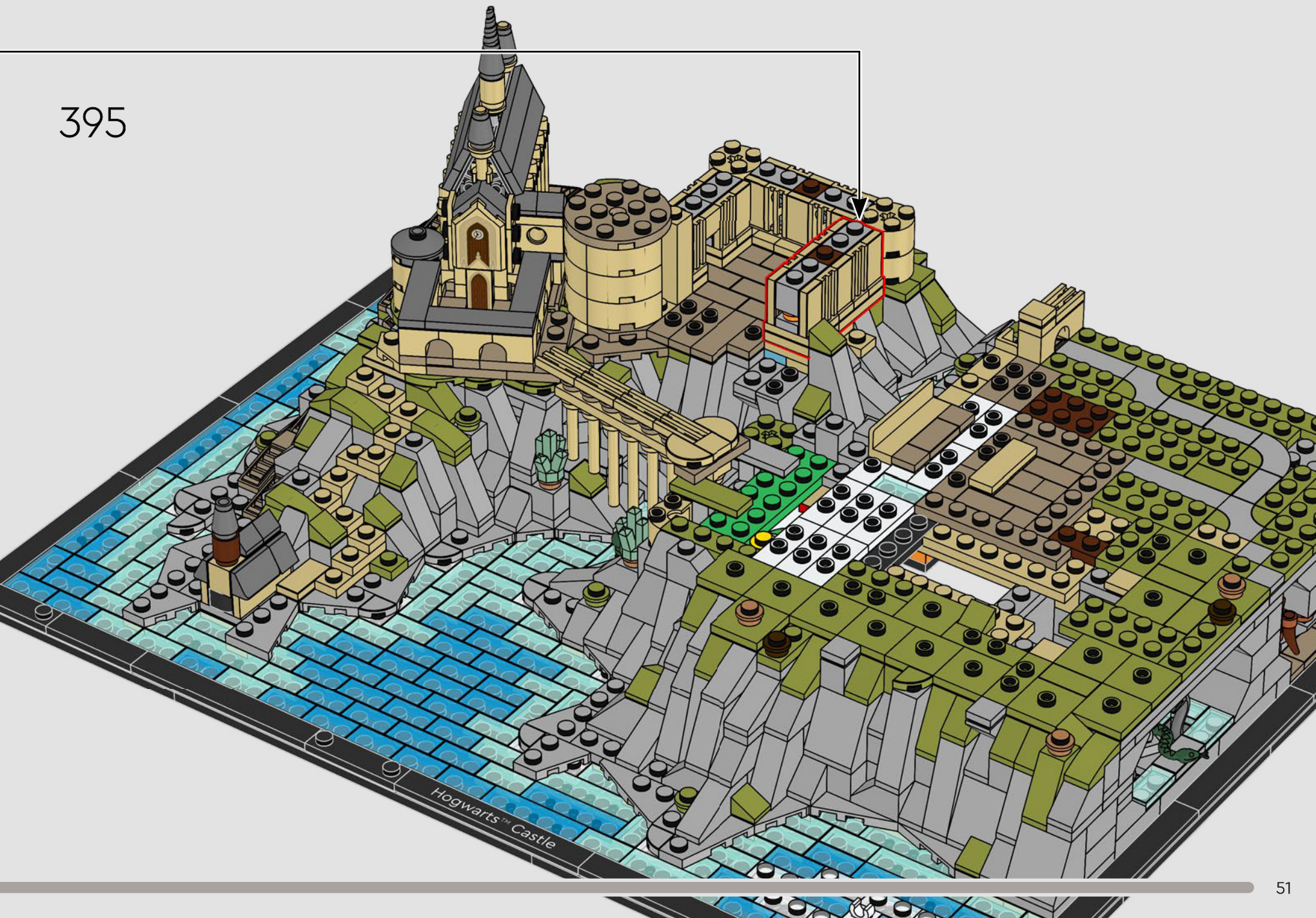

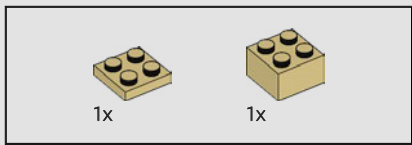

396

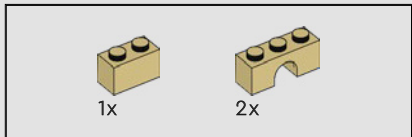
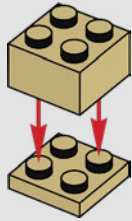

397

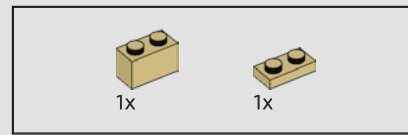
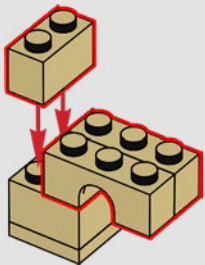

398

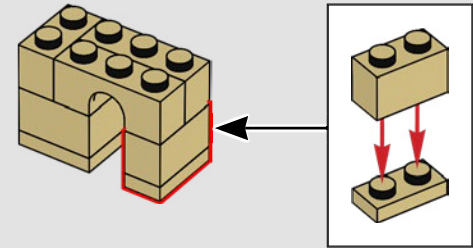

399

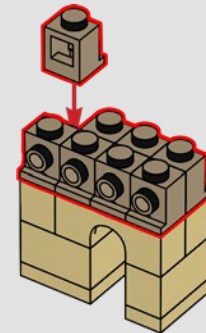

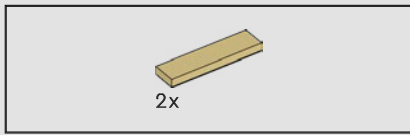

400

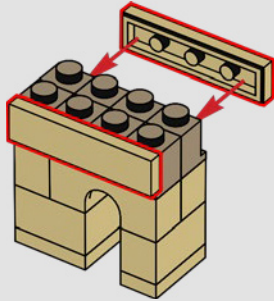

401

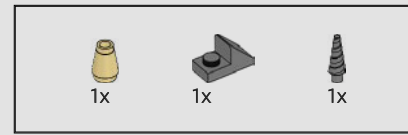
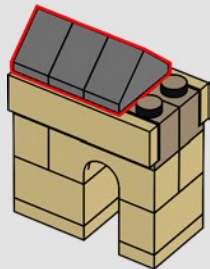

402

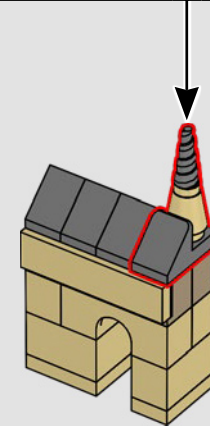
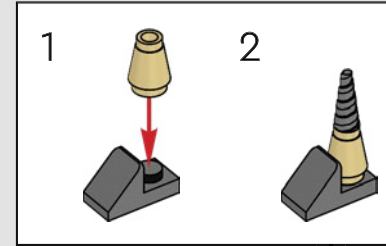

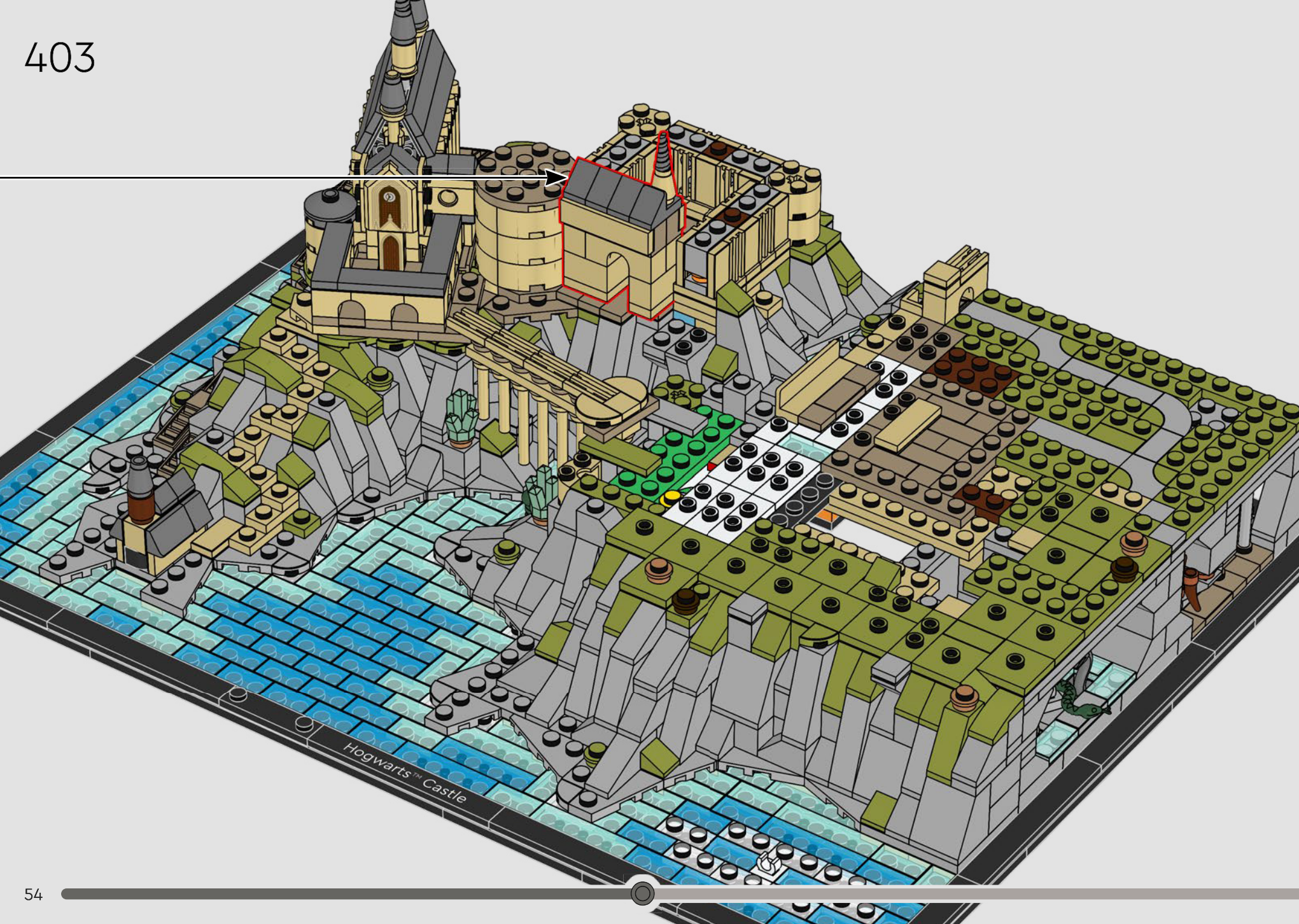

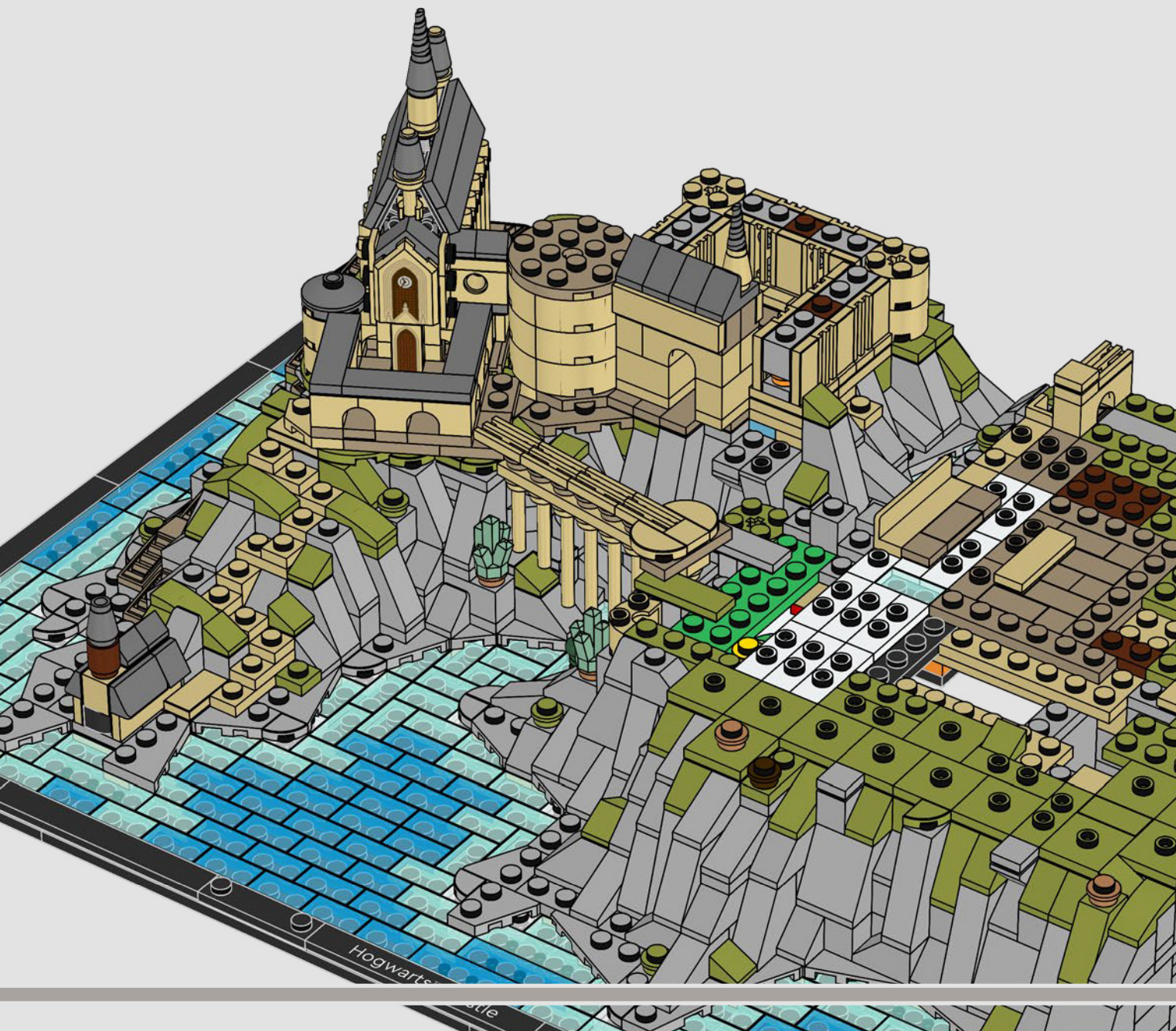

La Cour pavée est un espace de réunion extérieur situé près de la tour de l'horloge et réservé aux étudiants.

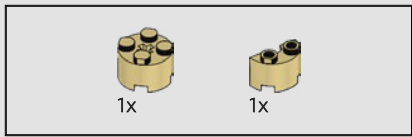

404

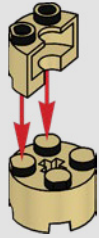

405

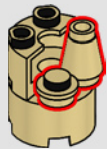

406

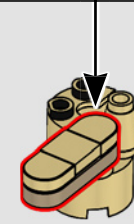
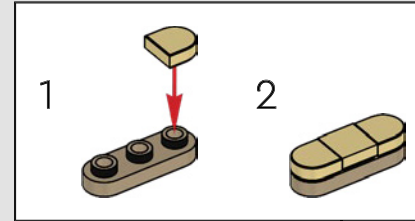

407

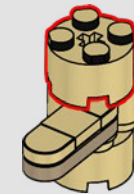

408







409

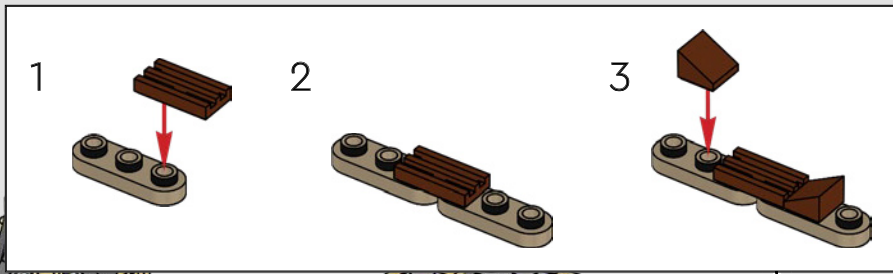

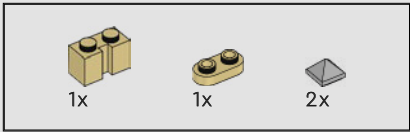

410

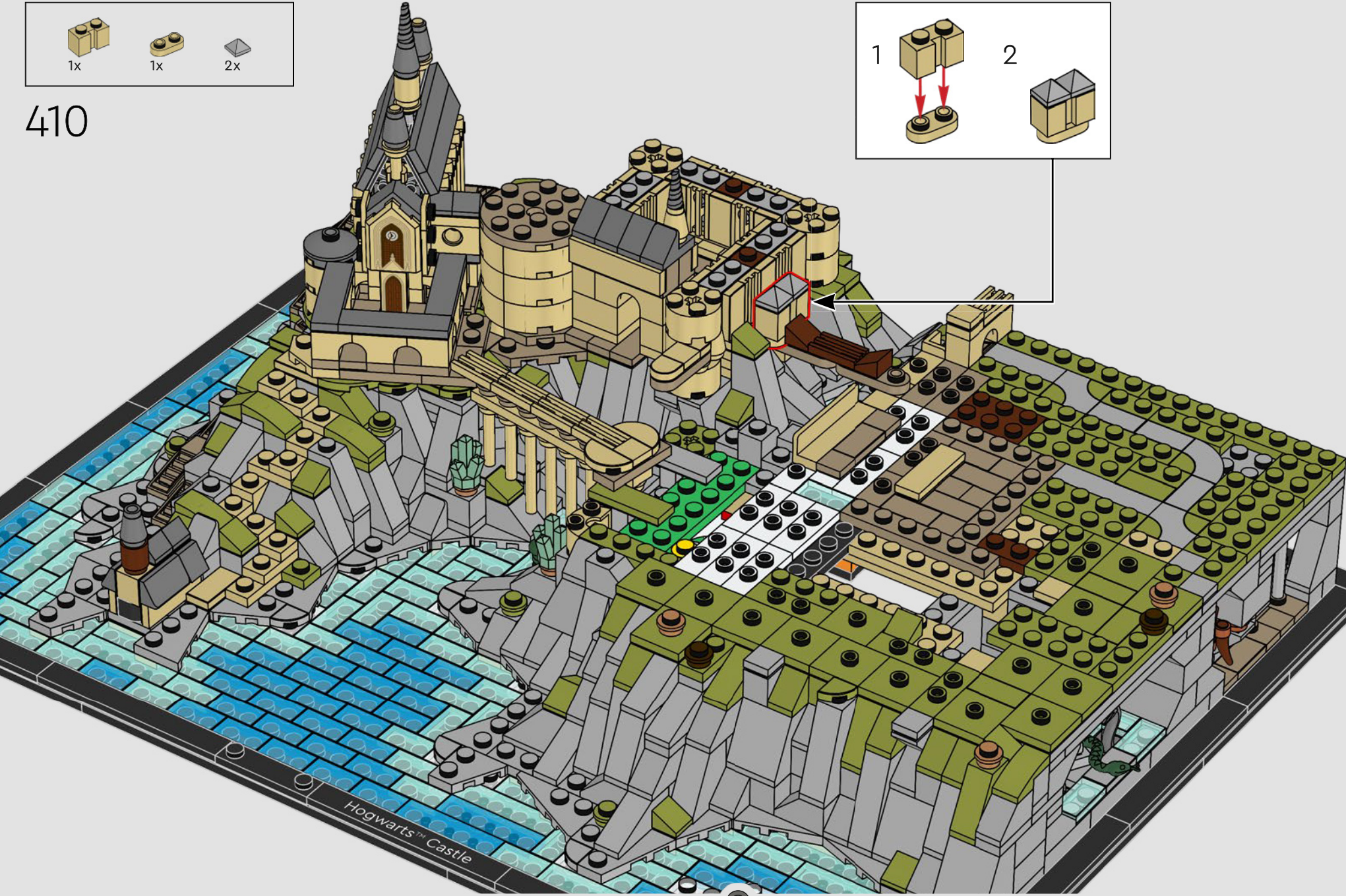
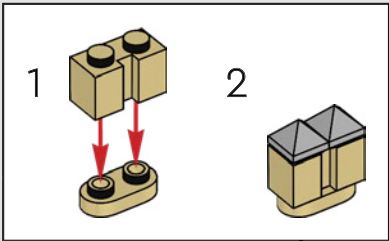

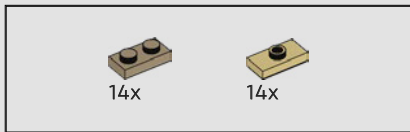

411

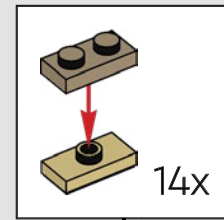

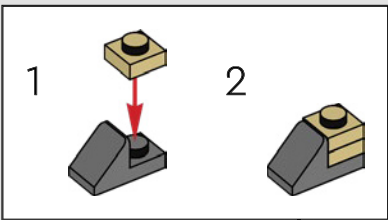
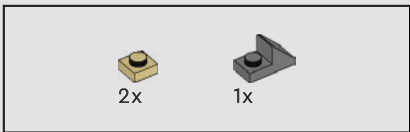

412

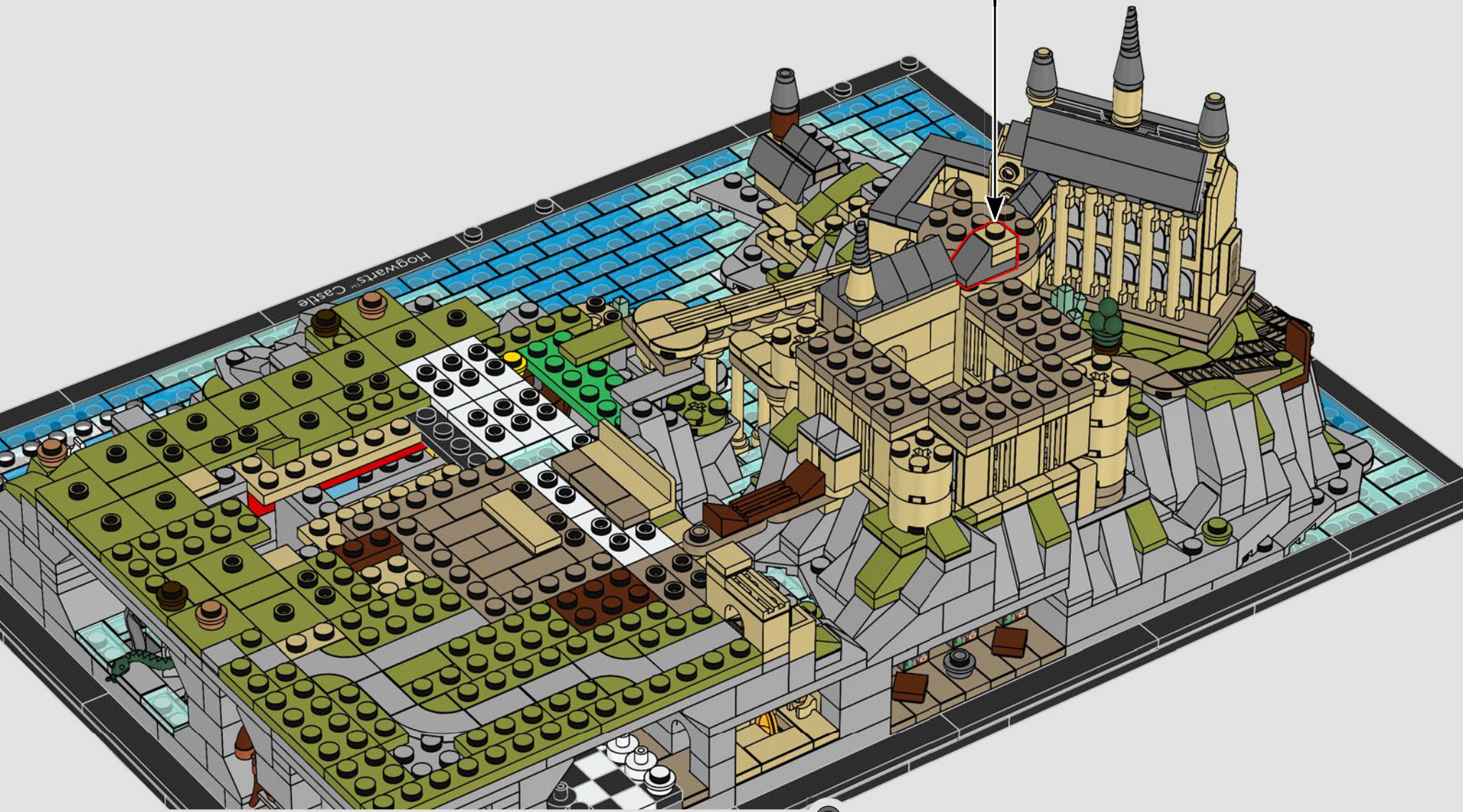

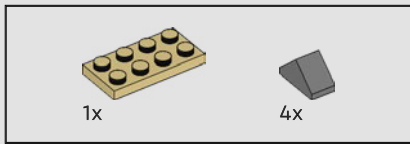

413

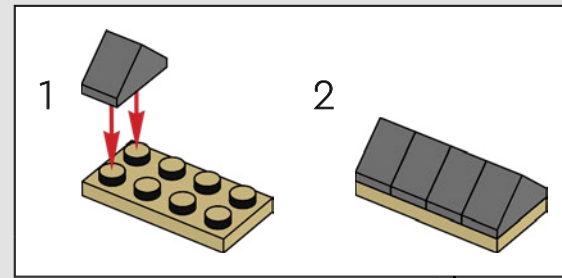

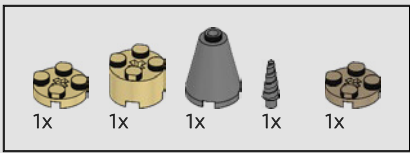

414

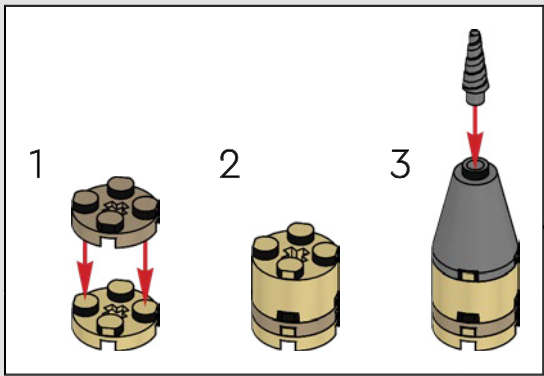

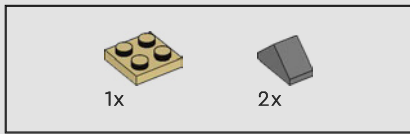

415

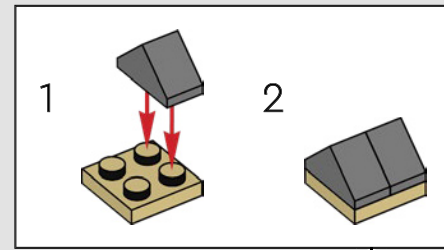

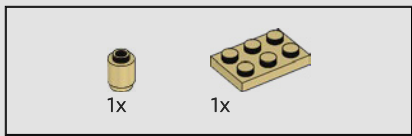

416

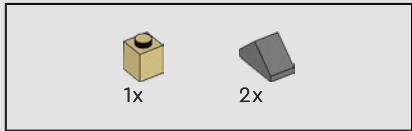
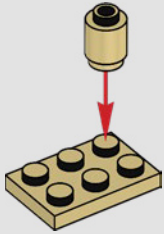

417

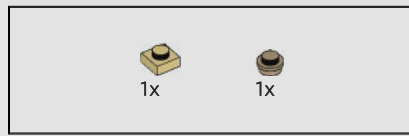
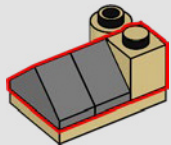

418

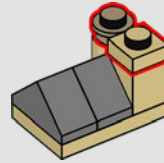

419

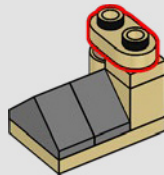

420

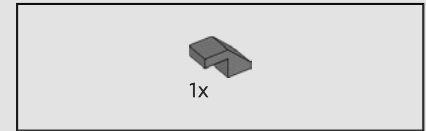
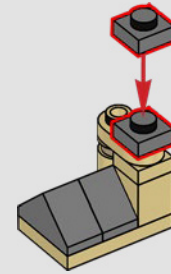

421

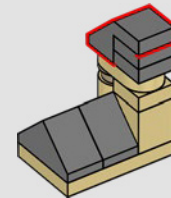

422

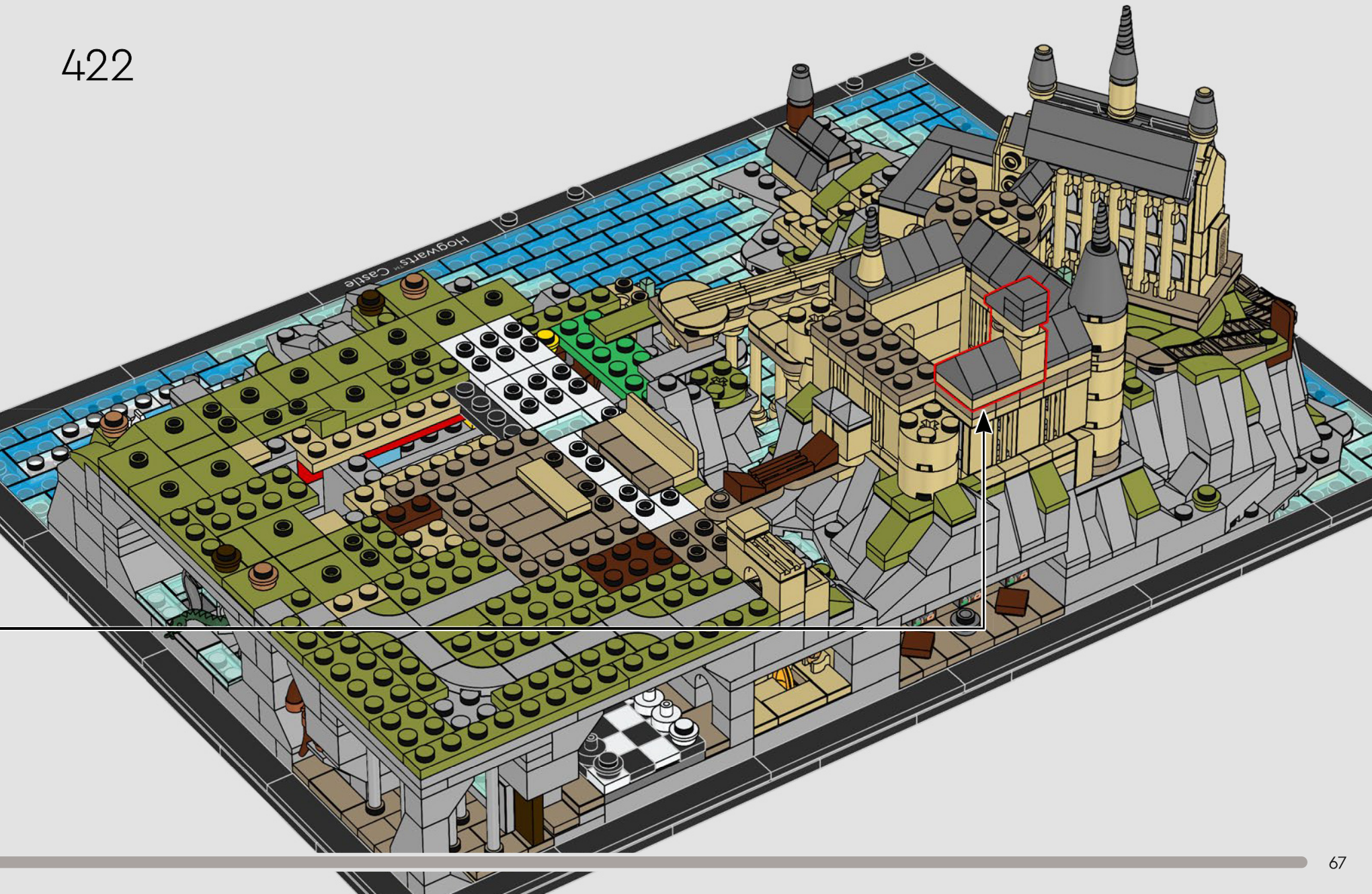

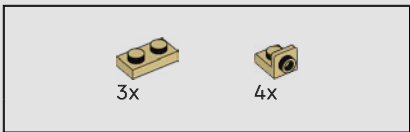

423



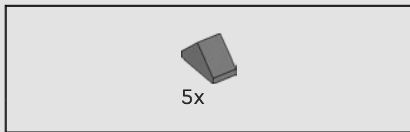

424



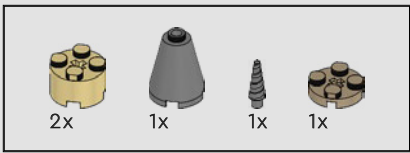

425

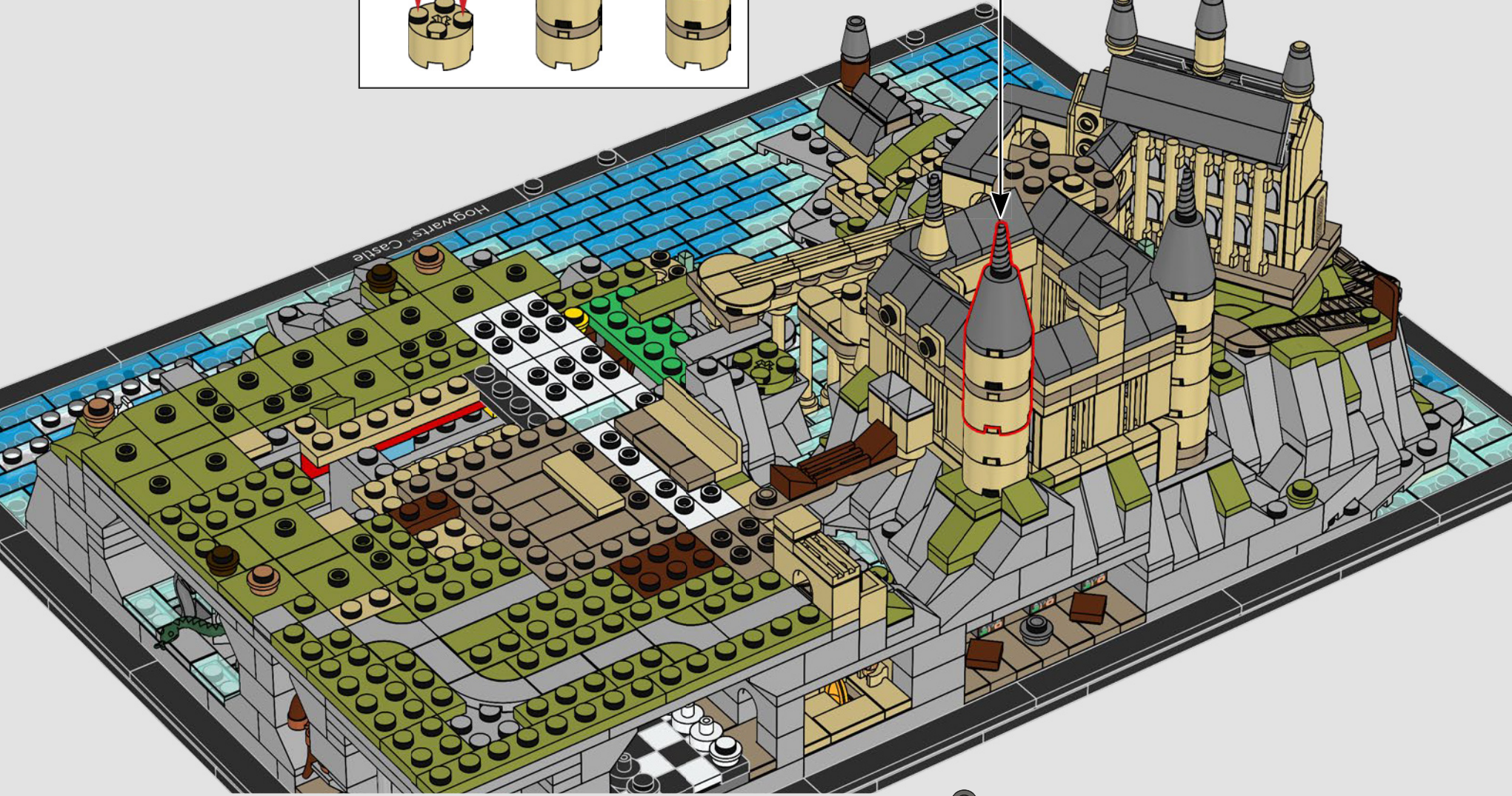
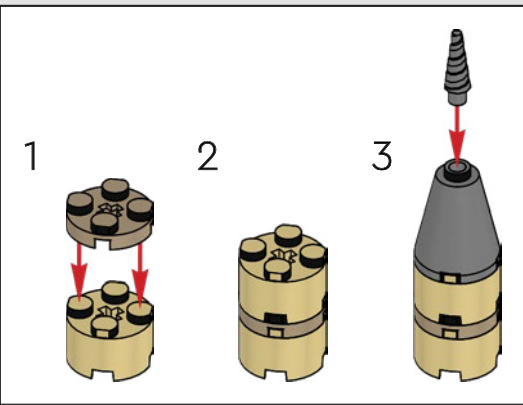

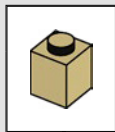
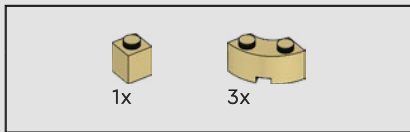

426

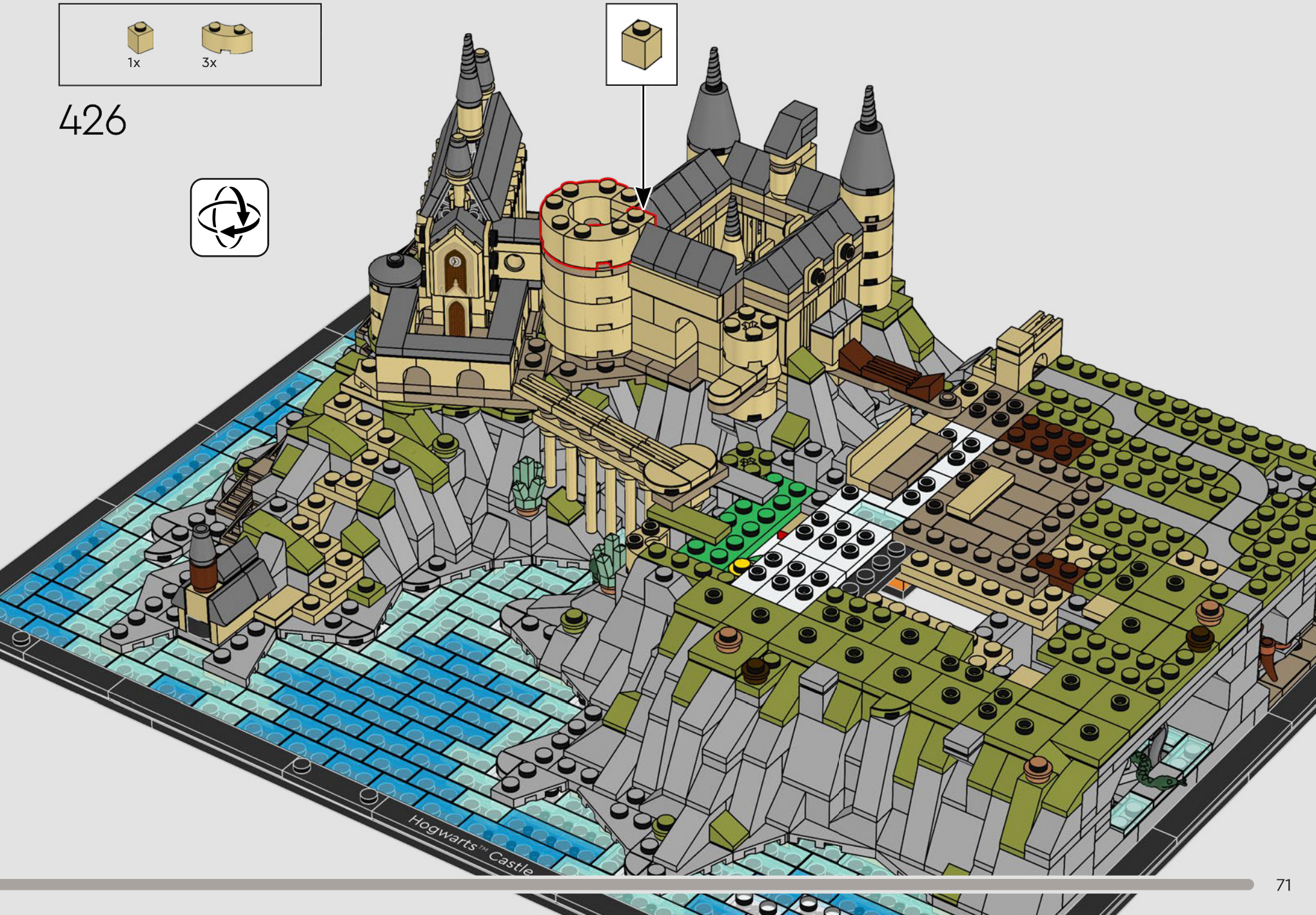

Hogwarts™ Castle

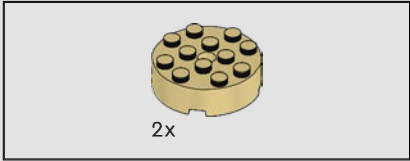
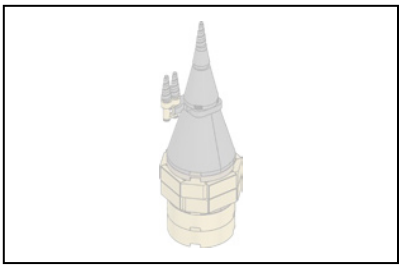

427

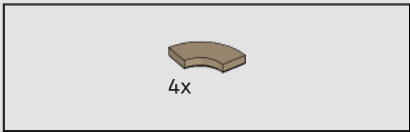
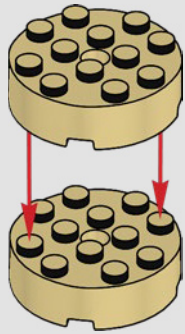

428

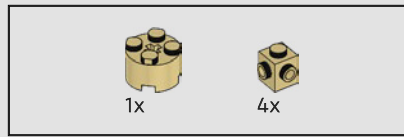
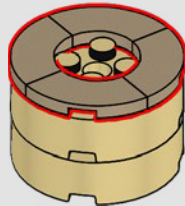

429

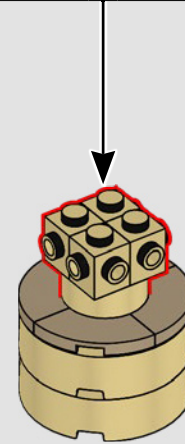
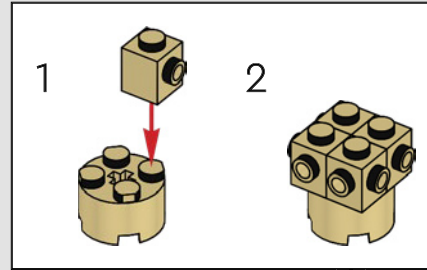

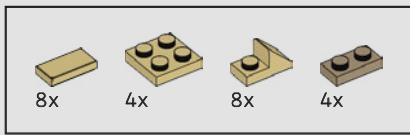

430

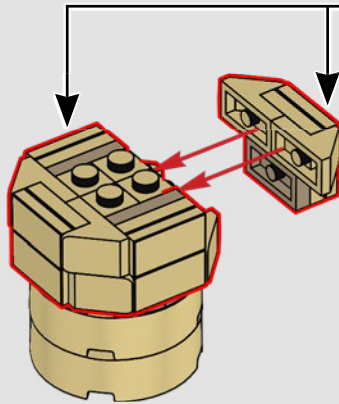
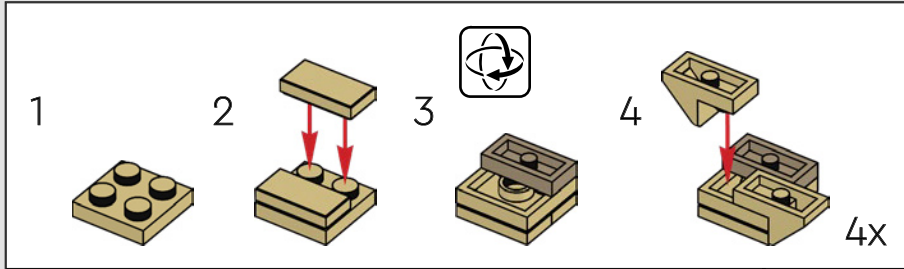

431

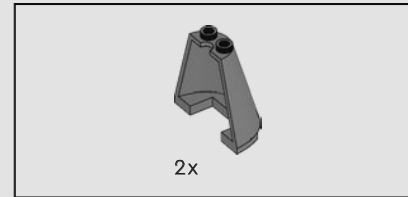
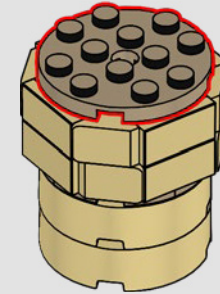

432

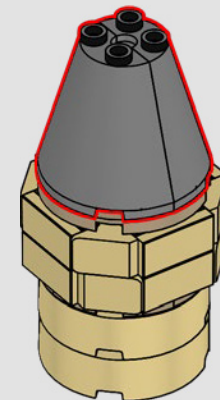

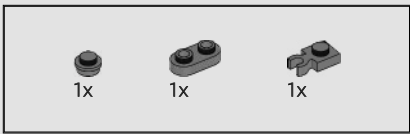

433

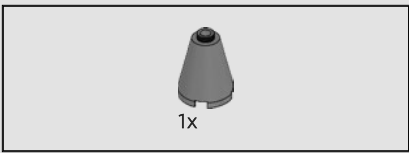
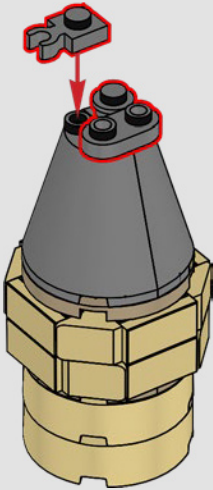

434

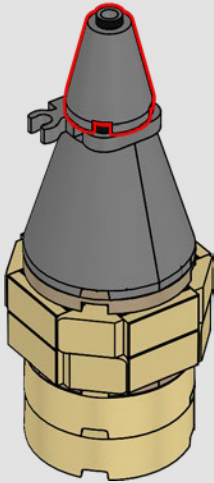

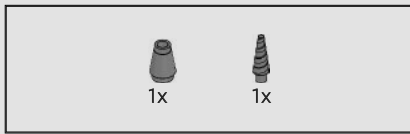

435

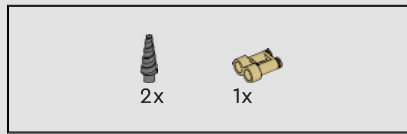
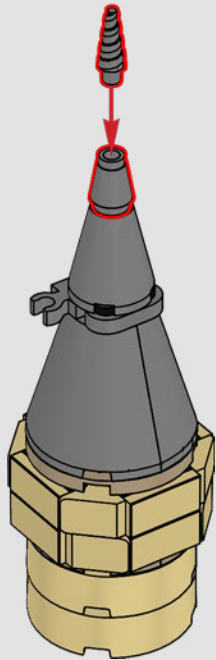

436

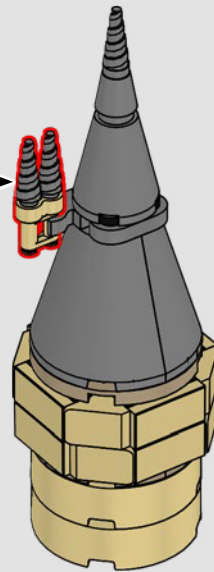
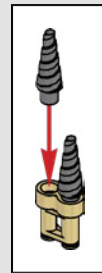

Le bureau d'Albus Dumbledore™, situé dans les petites tours de la tour principale, est, en réalité, un élément de télescope LEGO®.

437



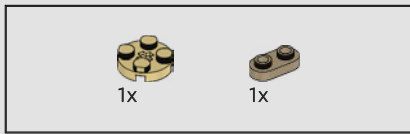

438

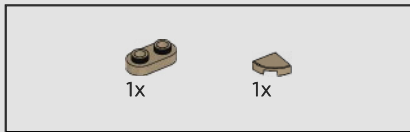
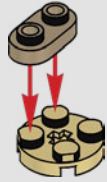

439

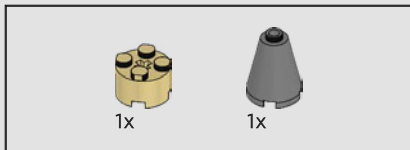

440

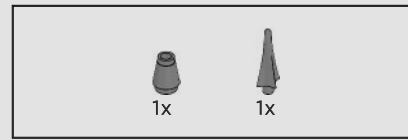
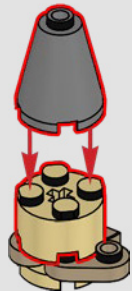

441

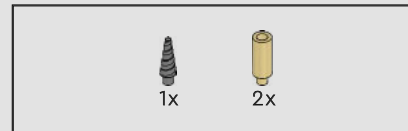
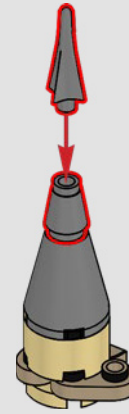

442

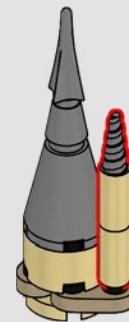
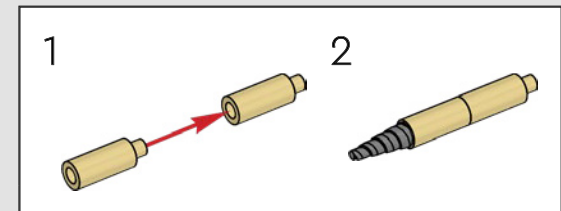

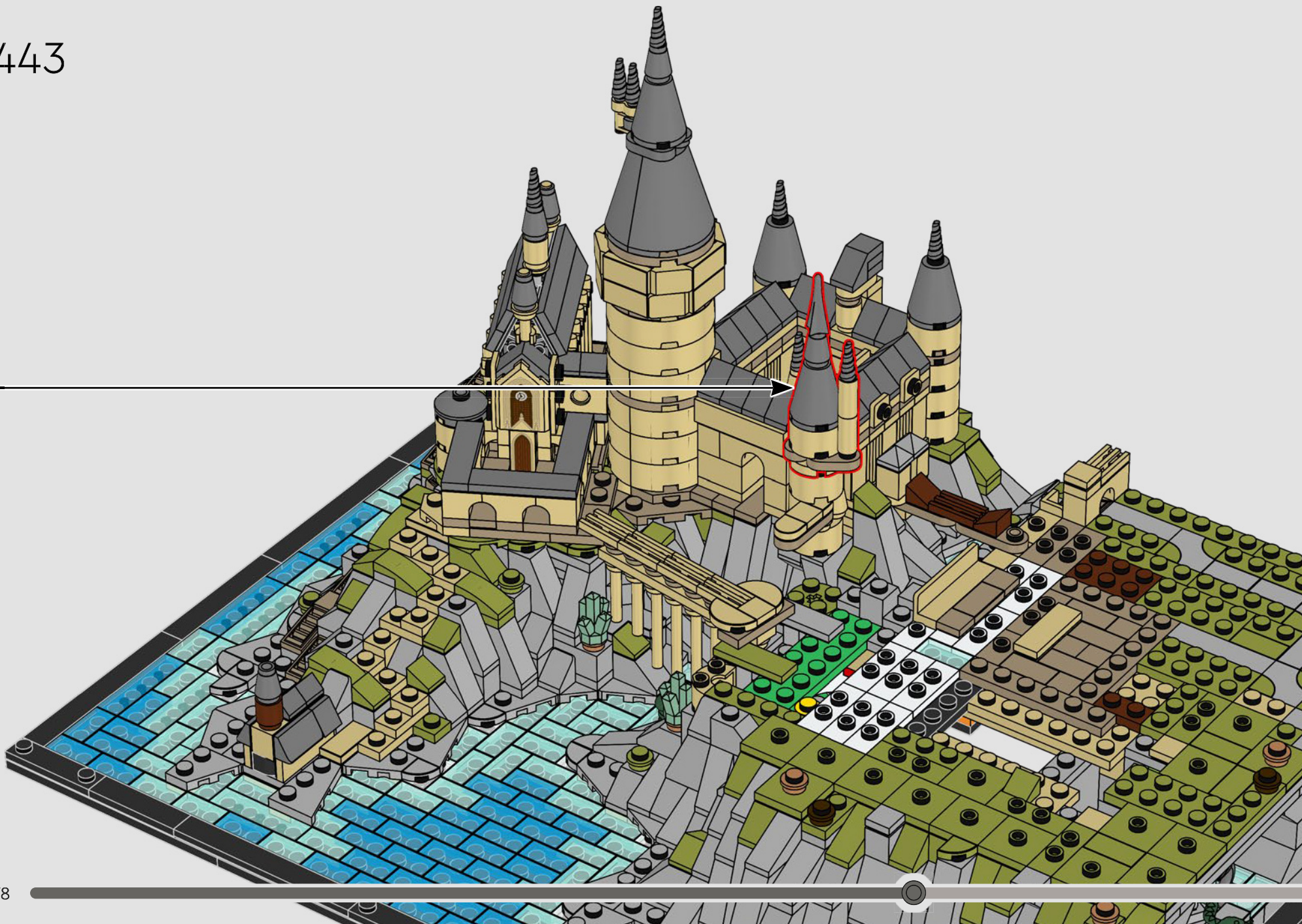



Vous ne pensiez tout de même pas que les tours qui avaient germé sur la tour du directeur étaient des structures durables d'un point de vue architectural – même si tout est possible à Poudlard !



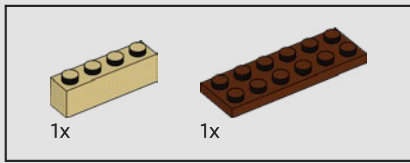

444

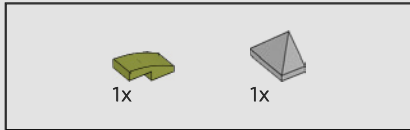
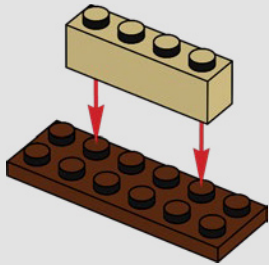

445

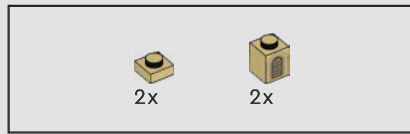
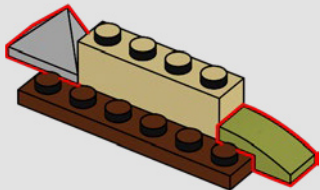

446

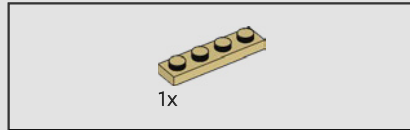
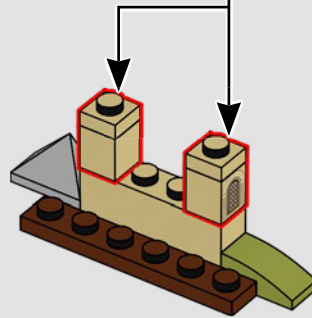
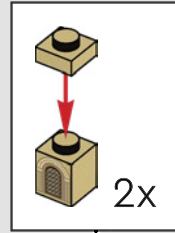

447

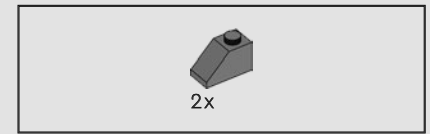
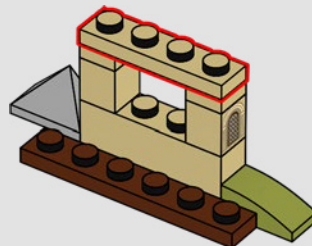

448

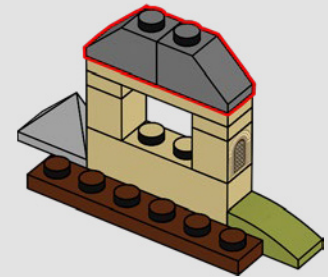

449

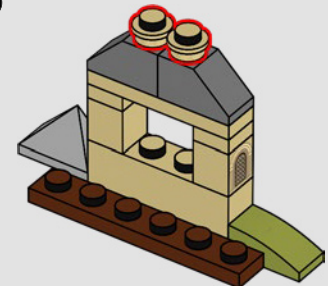

450

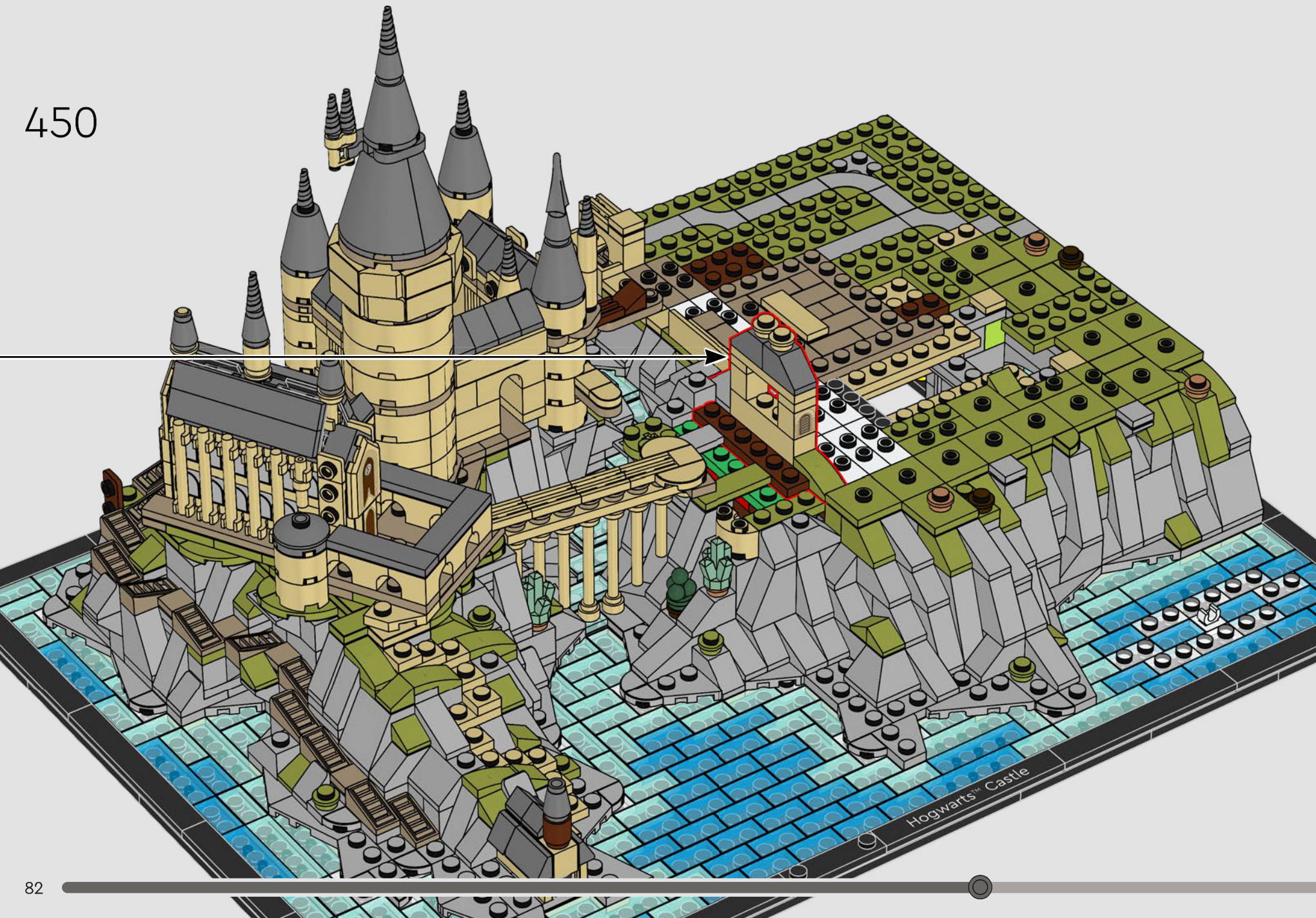

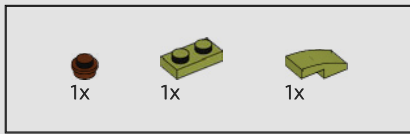

451

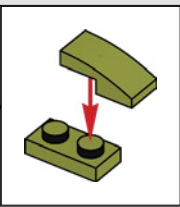
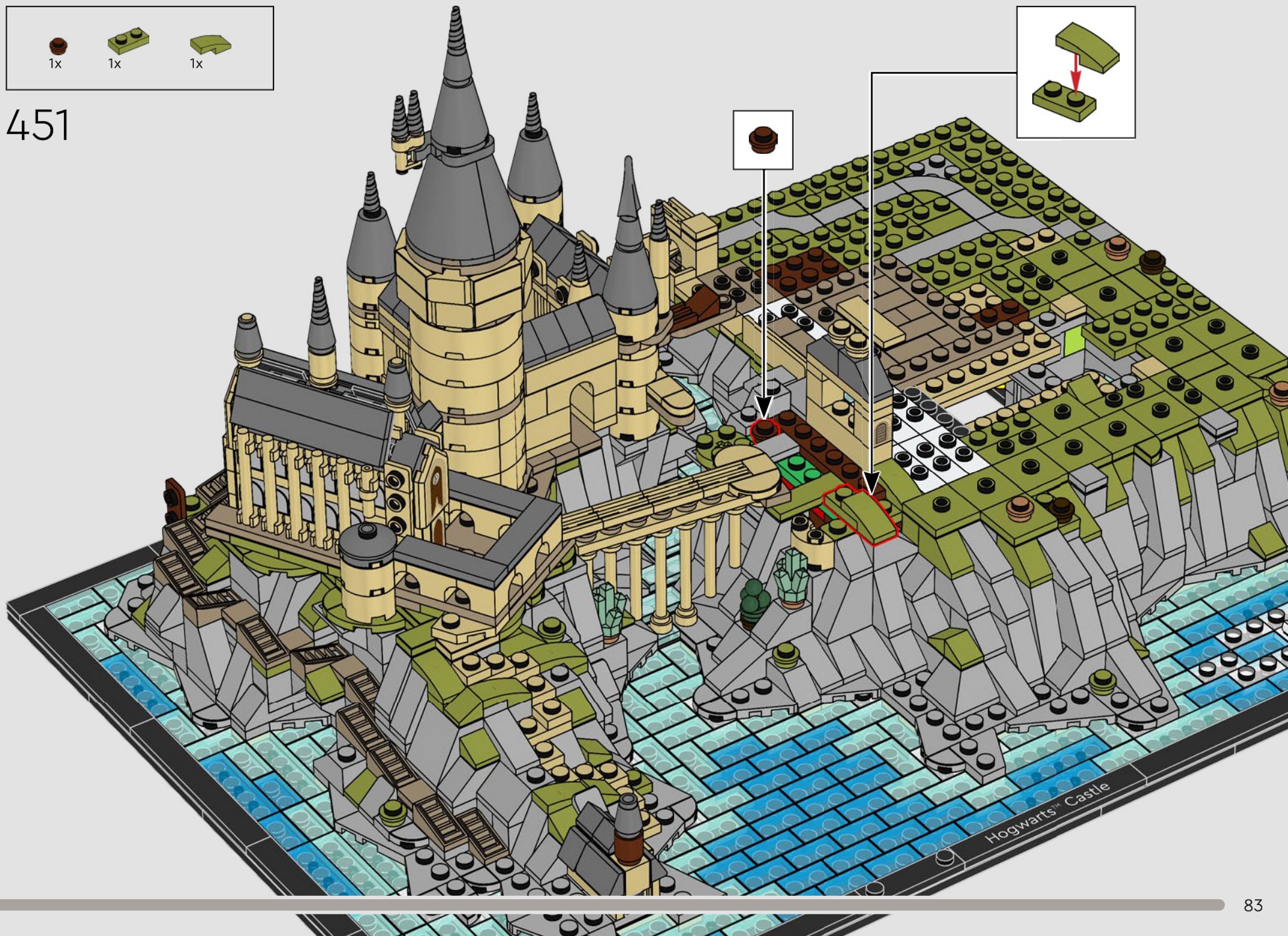

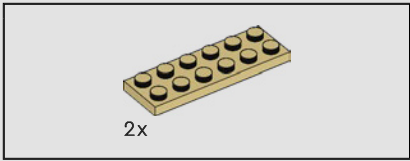

452

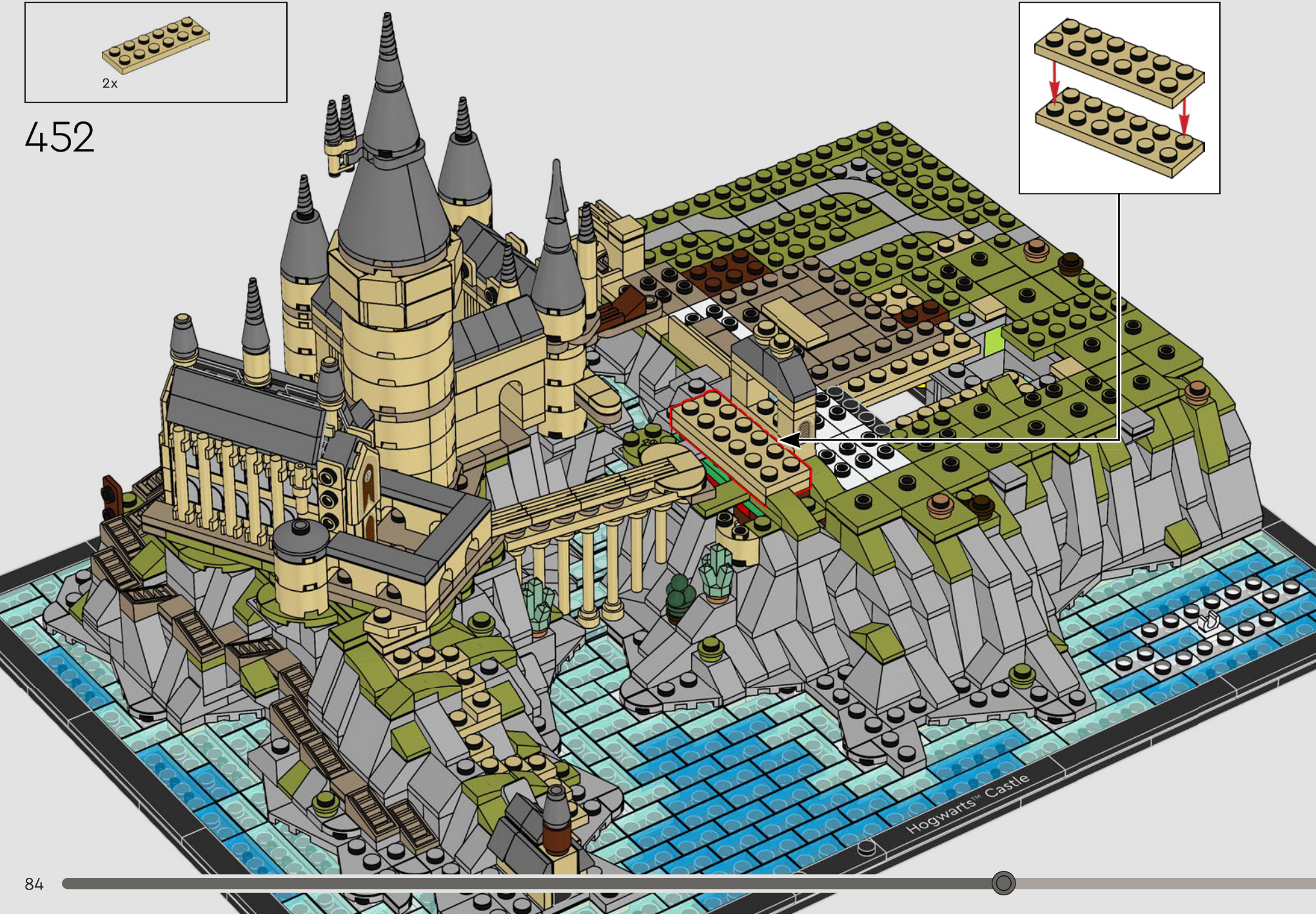
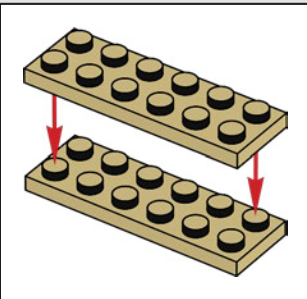



453

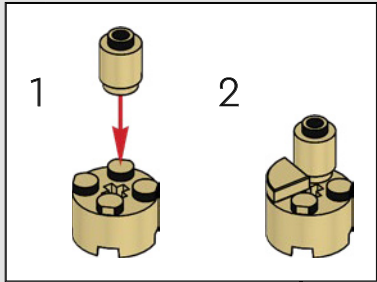



3x

454

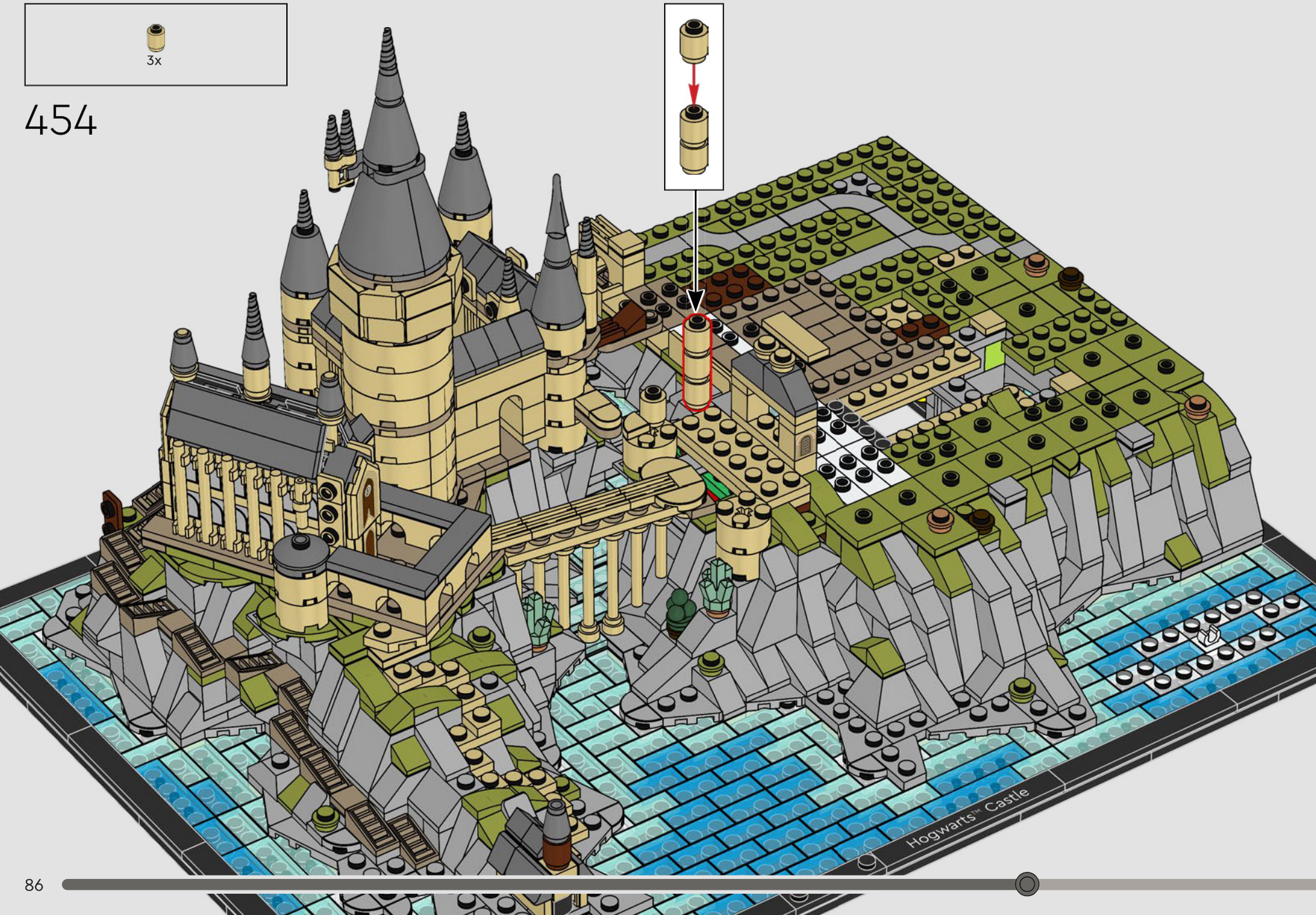
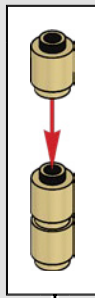

Hogwarts™ Castle

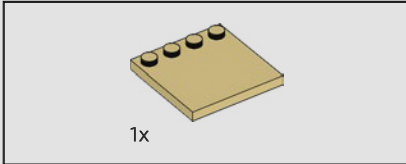
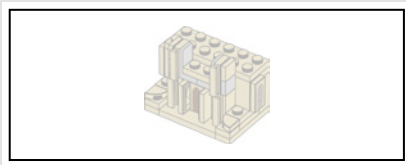

455

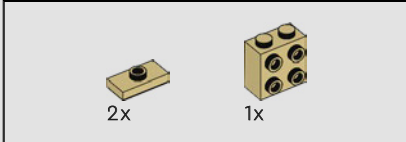
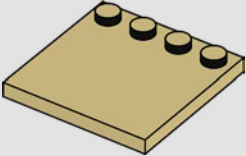

456

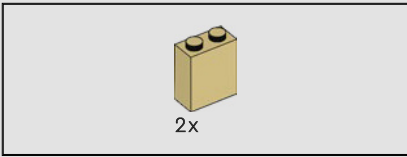
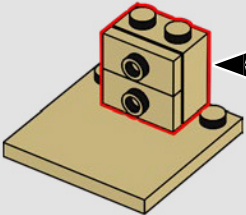
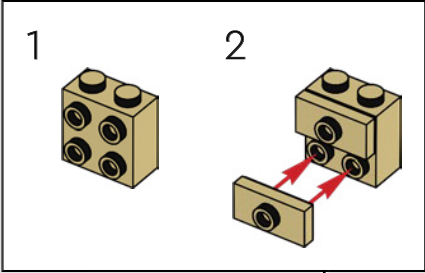

457

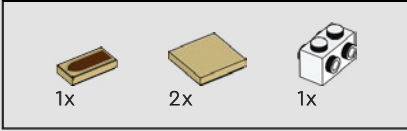
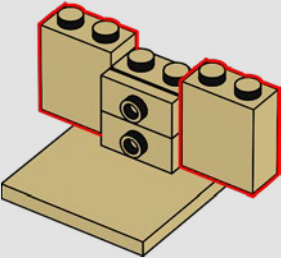

458

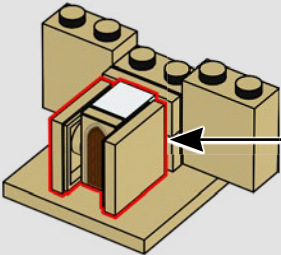
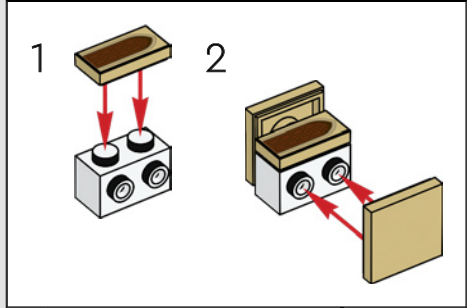

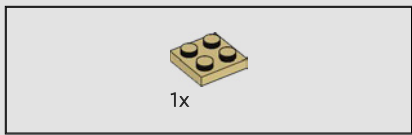

459

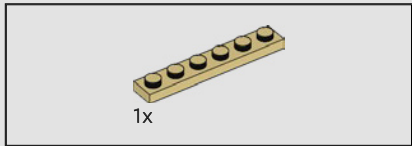
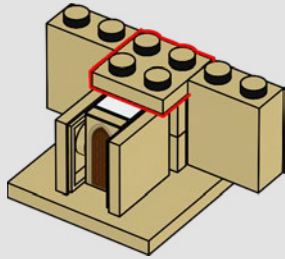

460

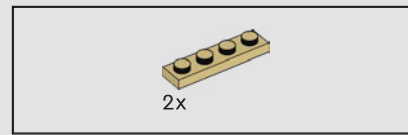
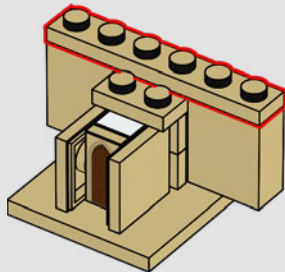

461

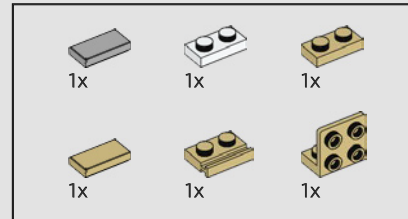
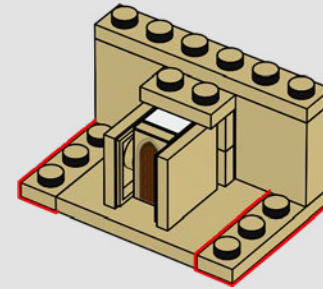

462

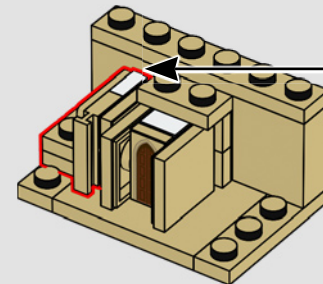
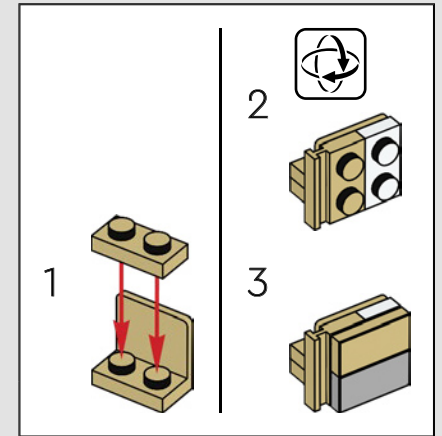

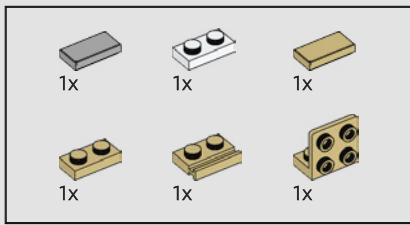

463

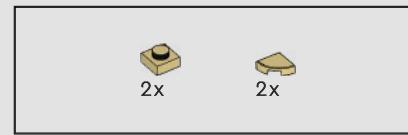
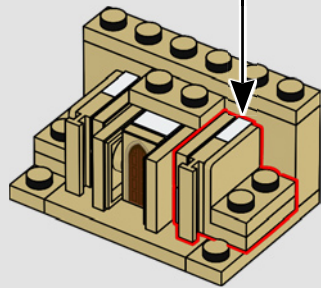
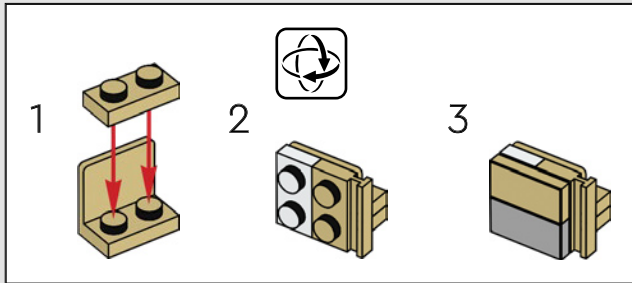

464

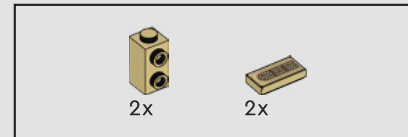
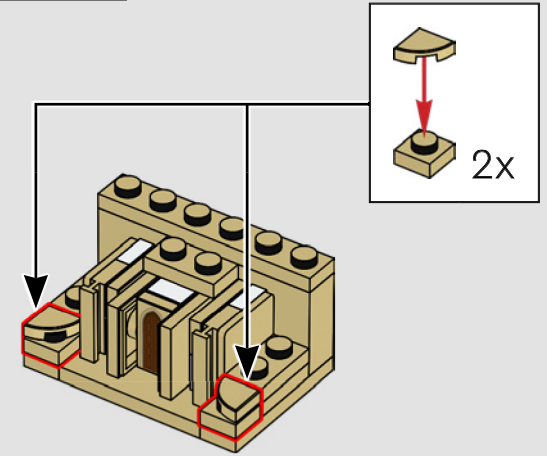

465

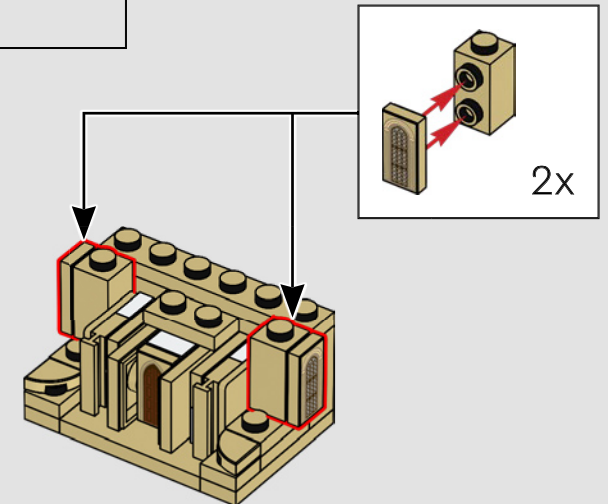

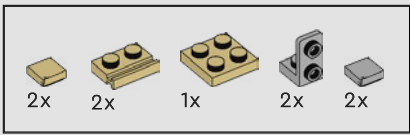

466

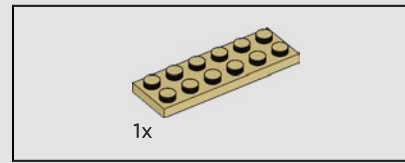
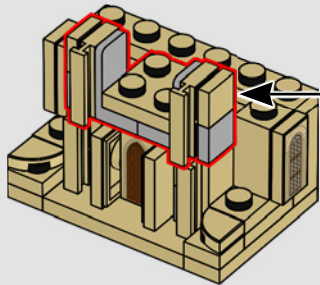
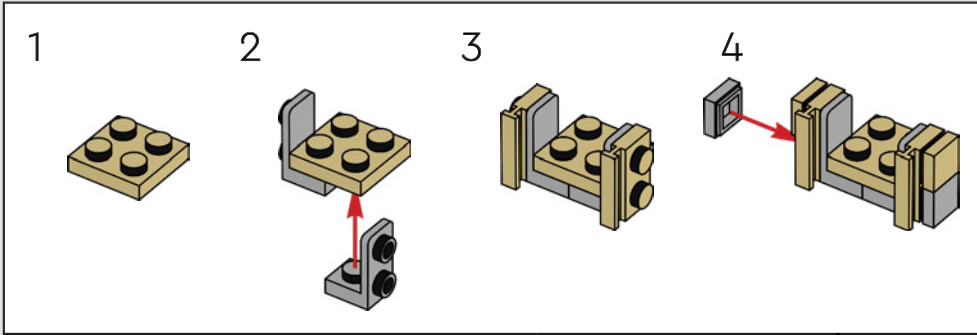

467

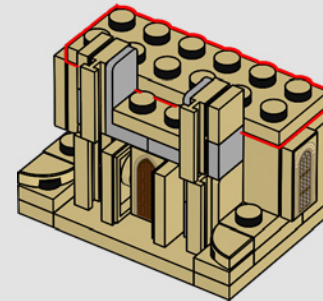

468

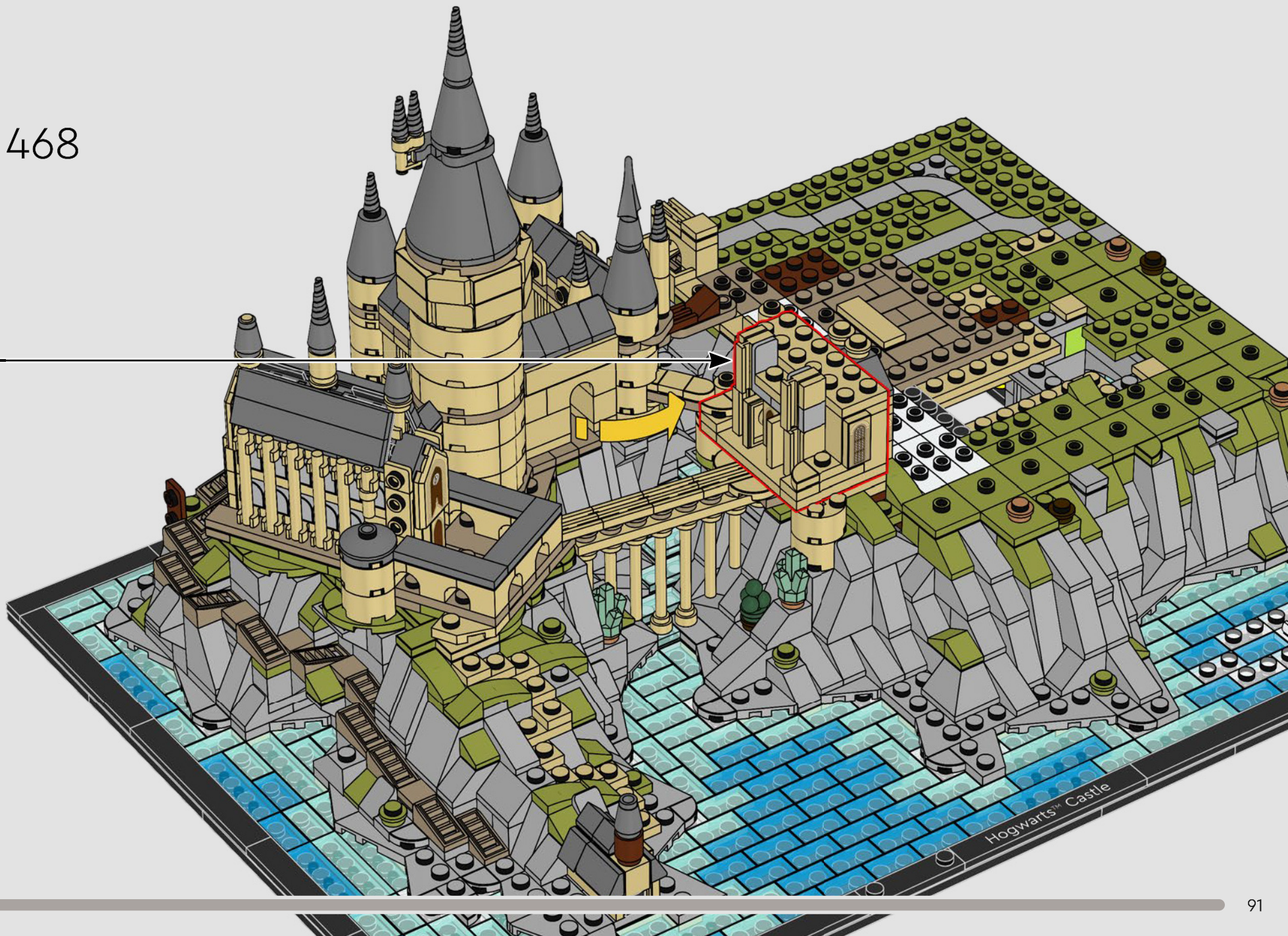

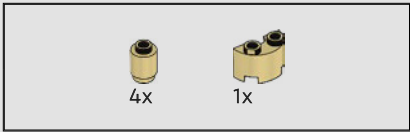

469

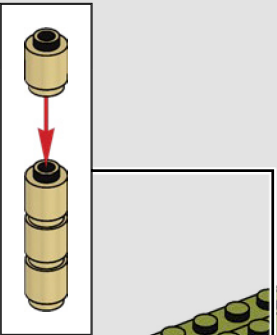



470

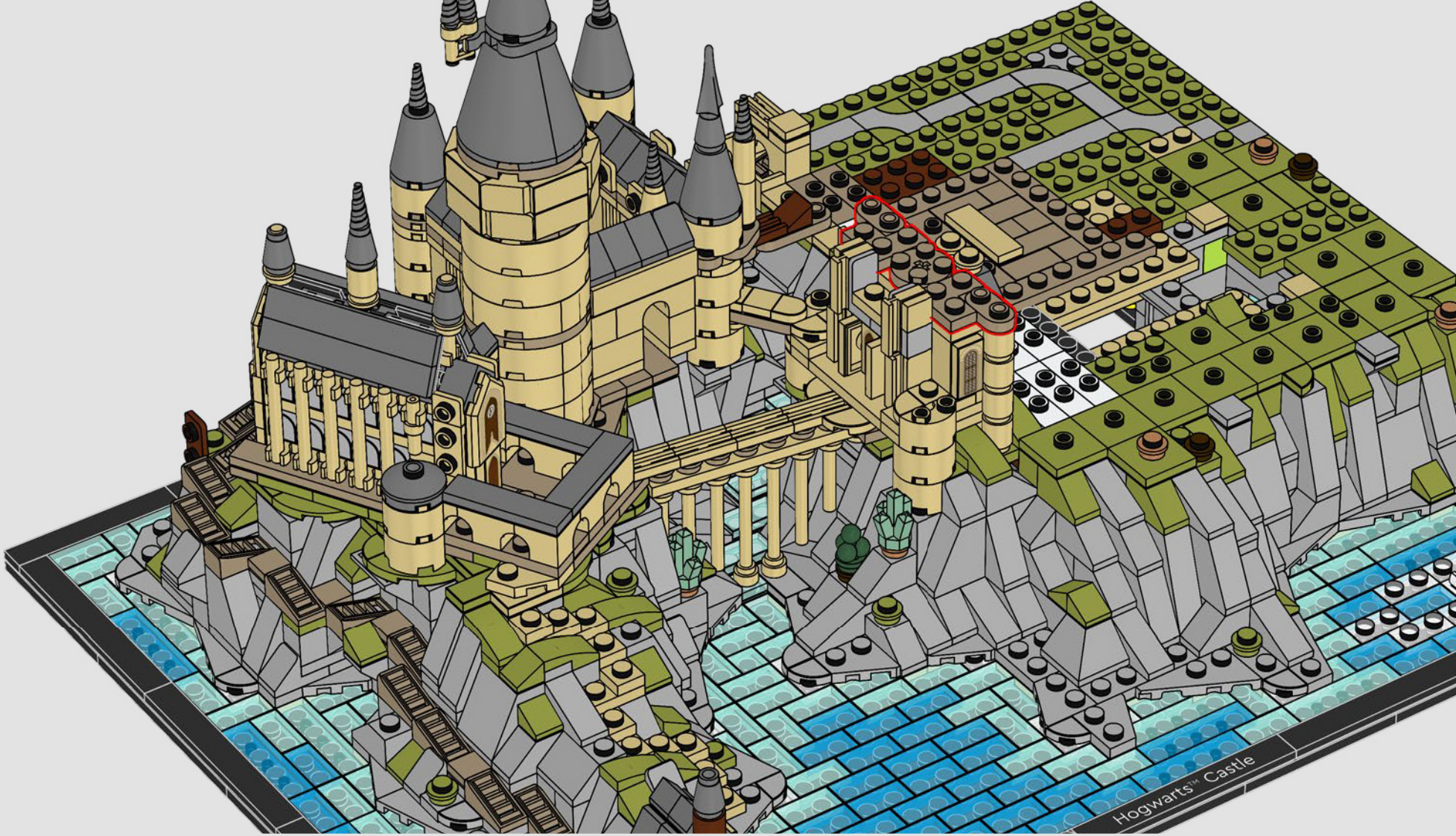

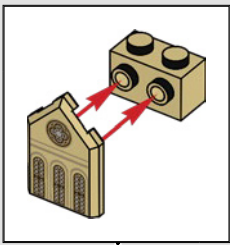
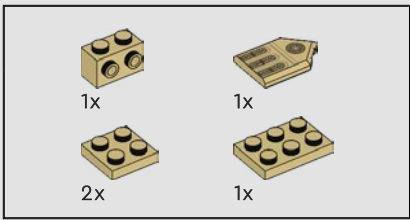

471

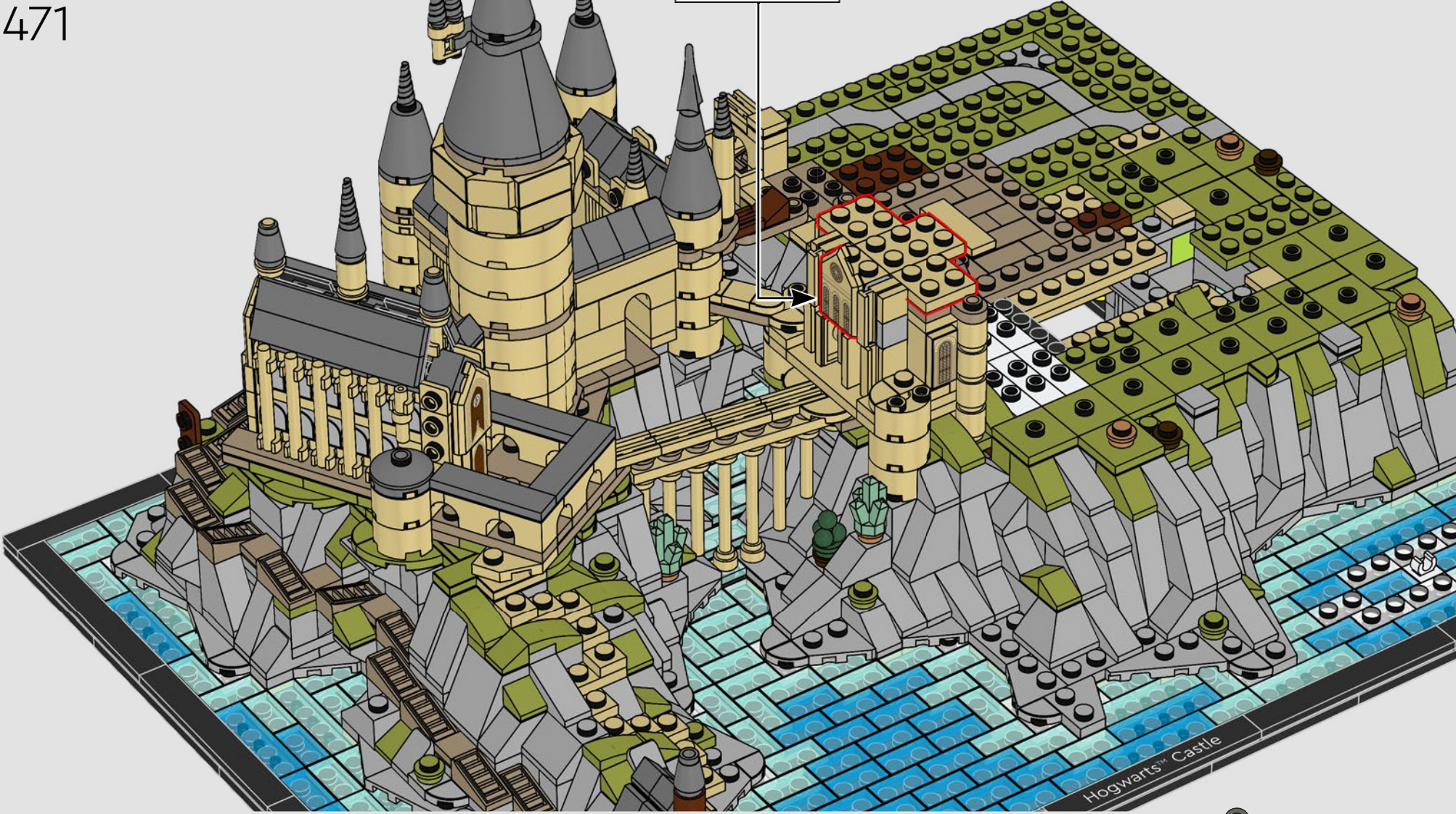



472

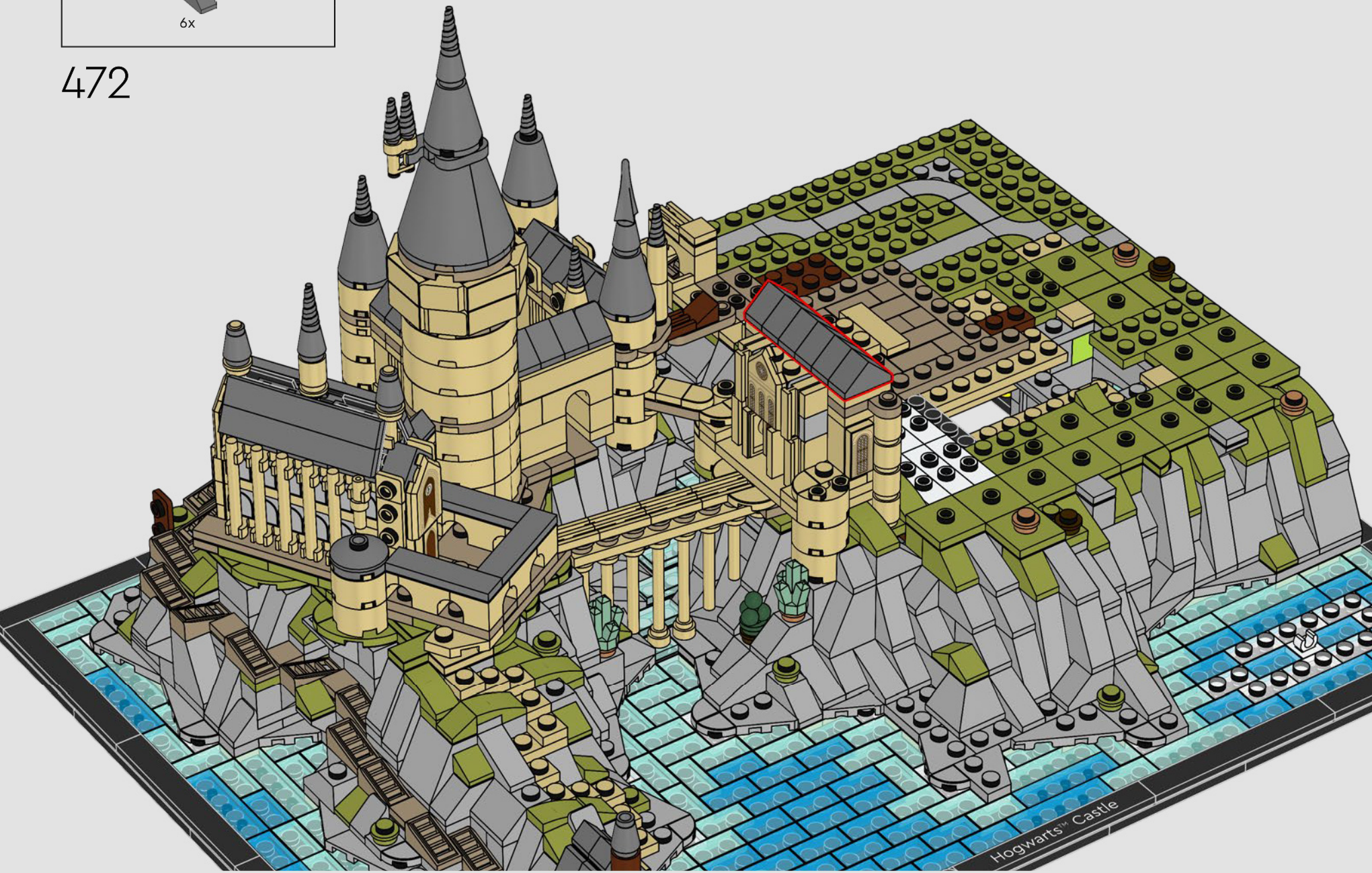

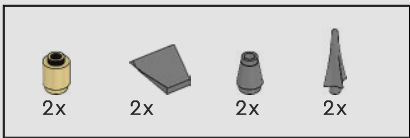

473

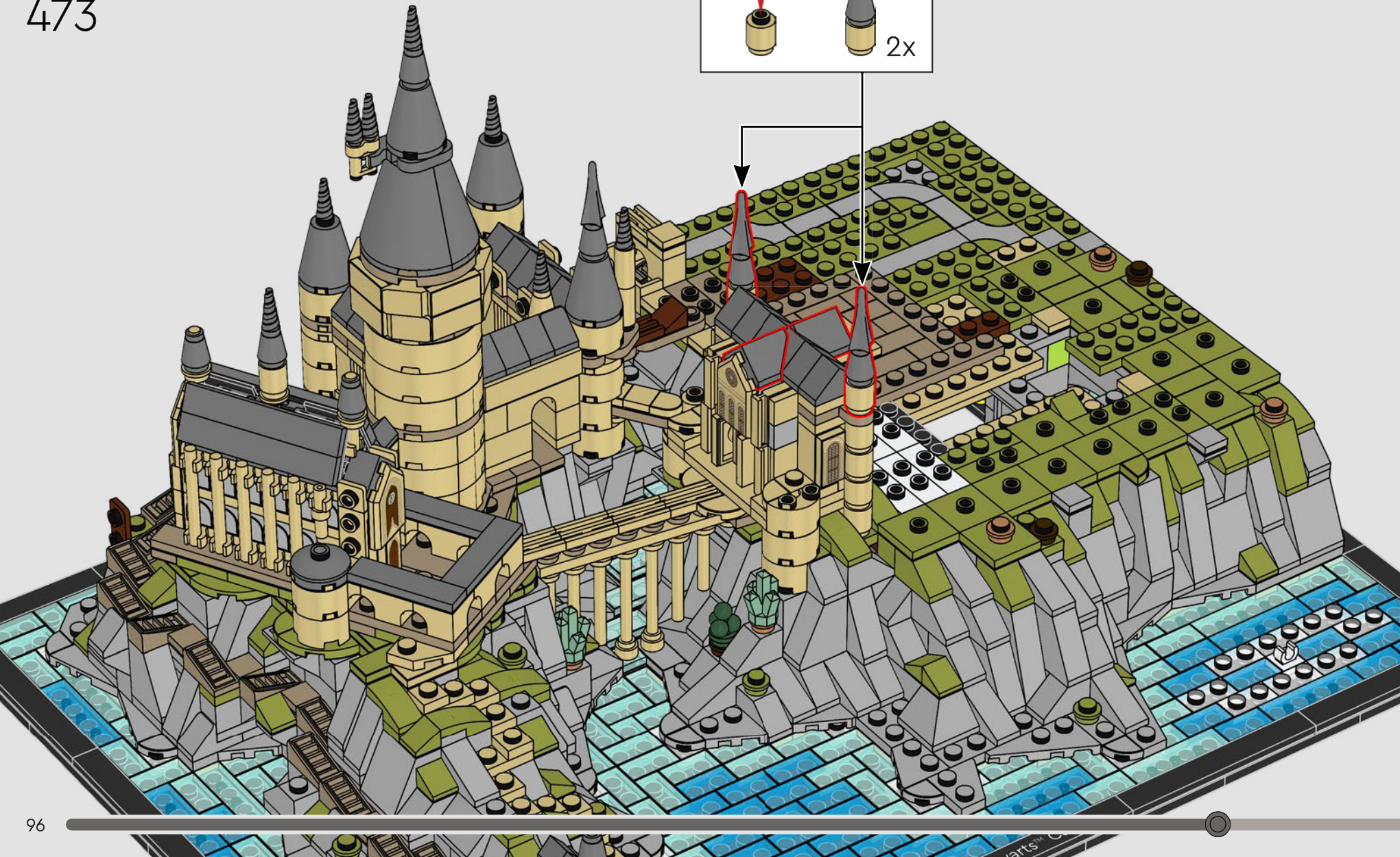
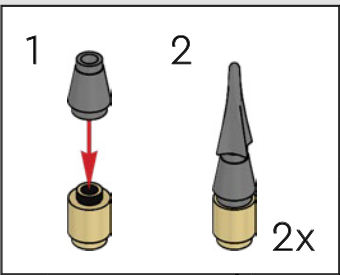

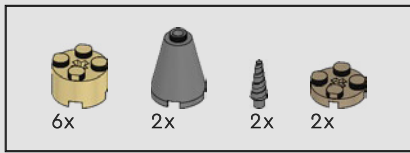

474

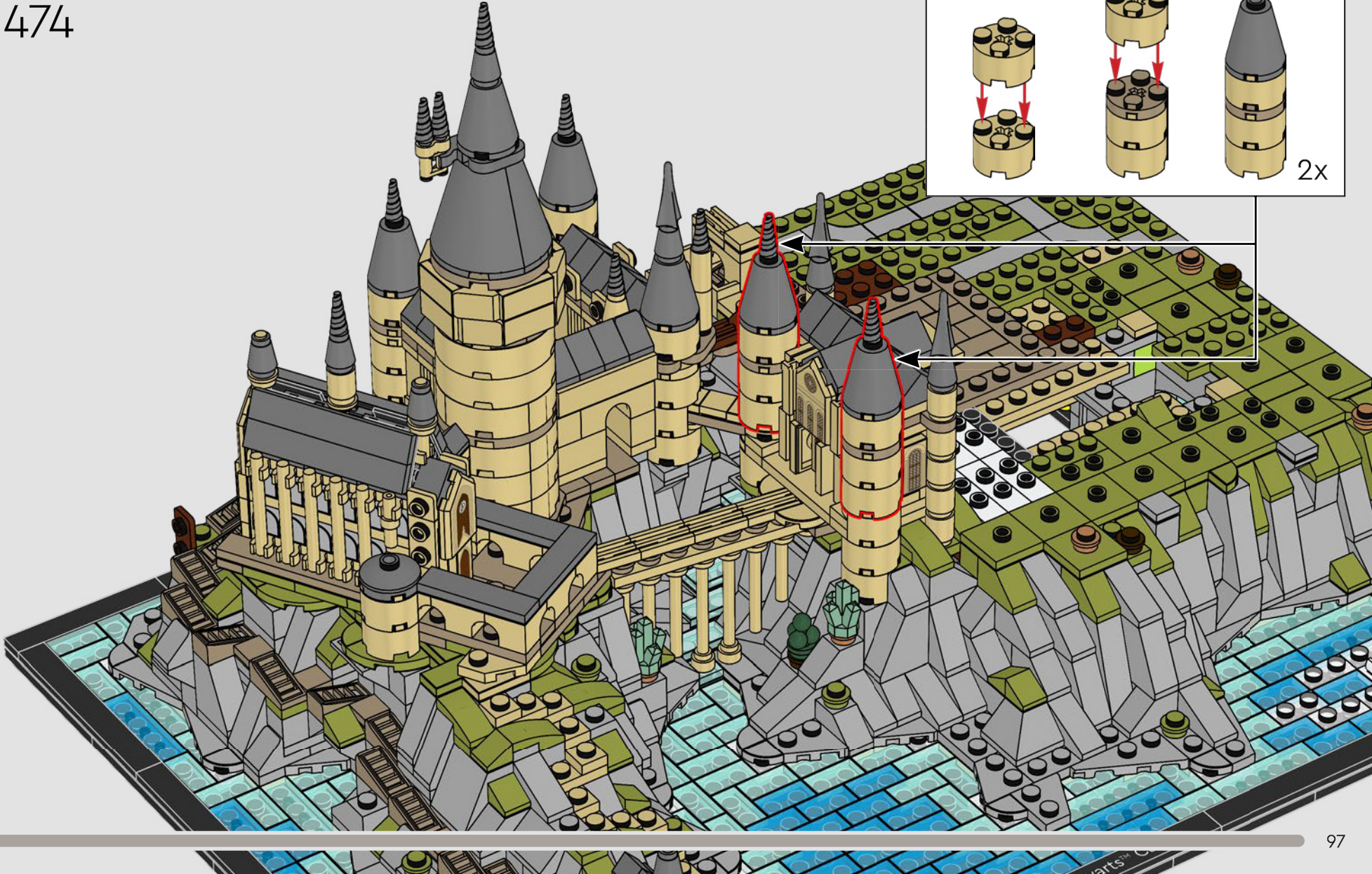
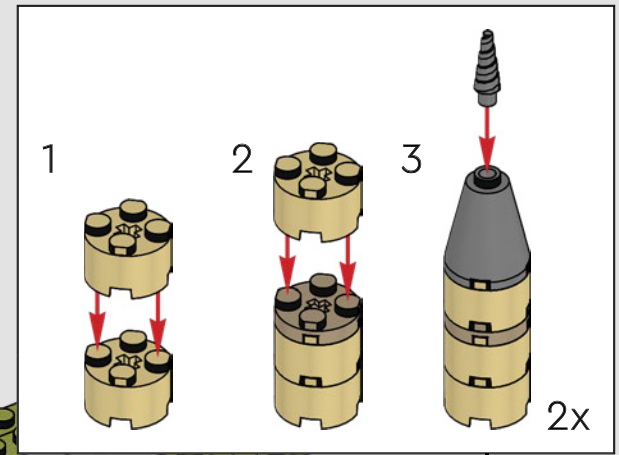

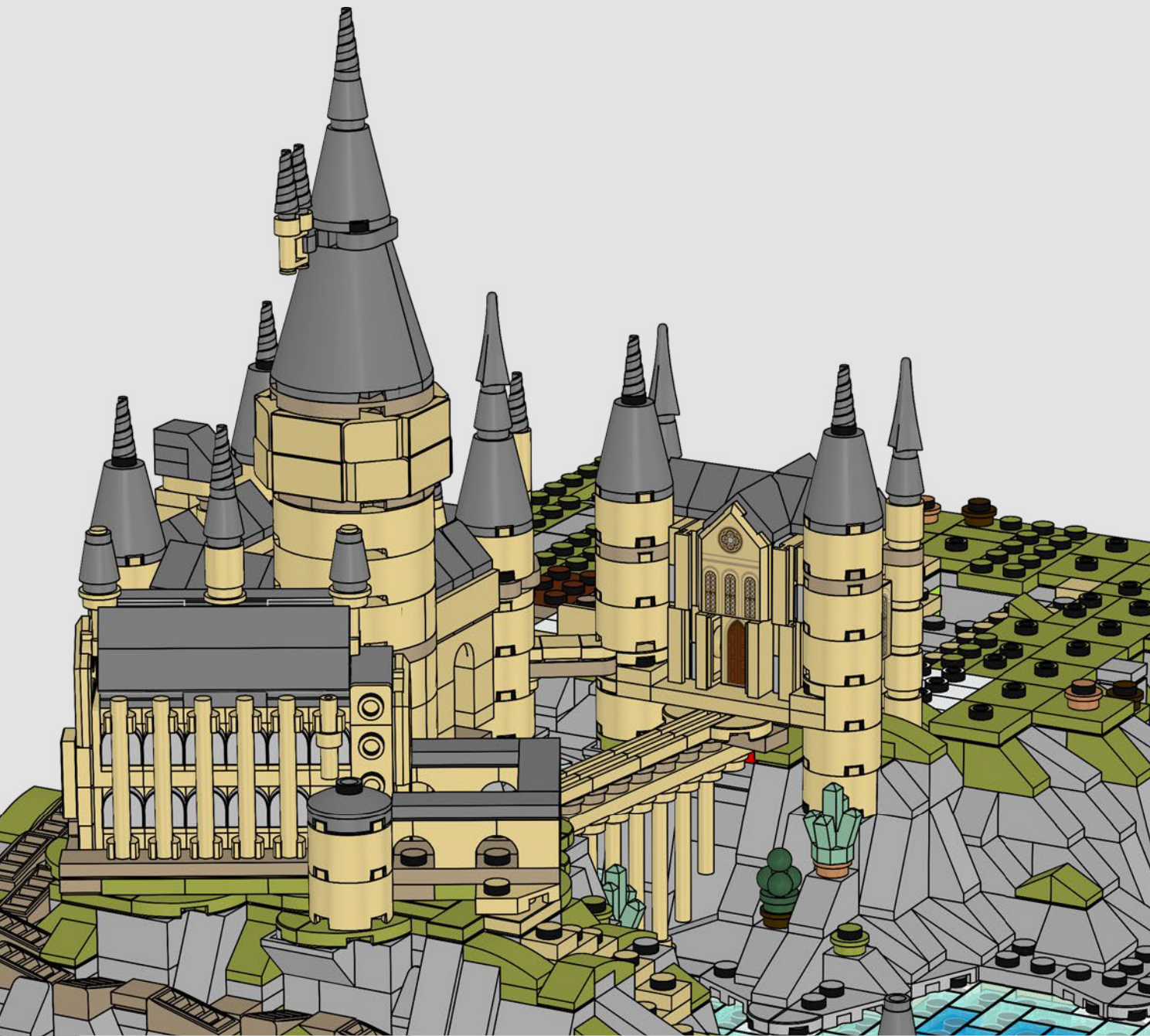

Les toilettes des filles se trouvent dans cette partie du château. Vous y croiserez peut-être Mimi Geignarde pendant la construction. Mais attention aux trolls.





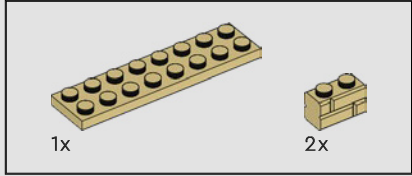
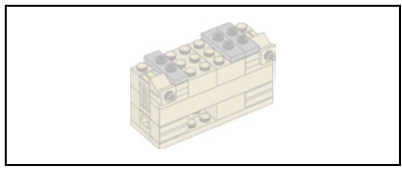

475

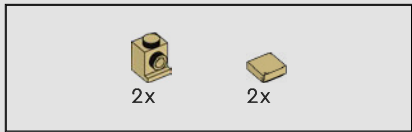
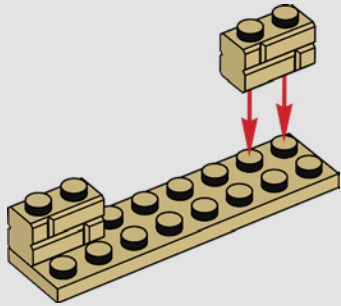

476

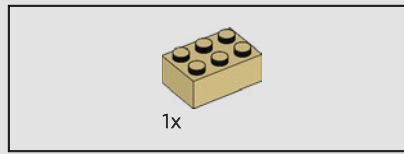
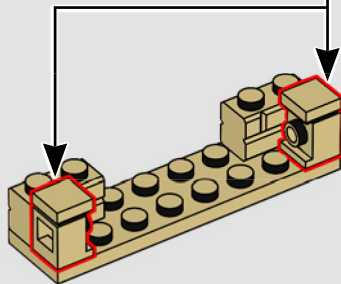
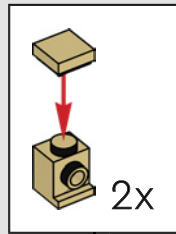

477

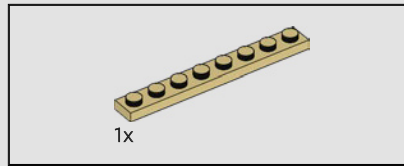
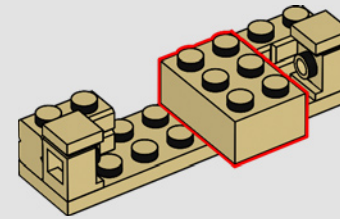

478

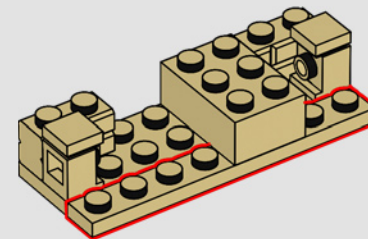

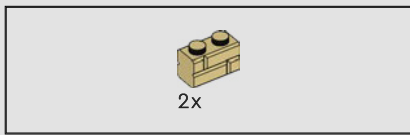

479

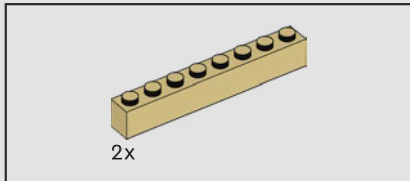
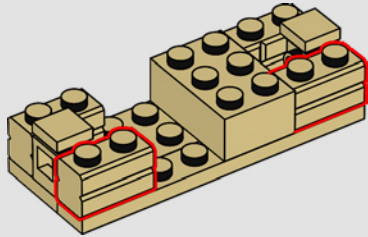

480

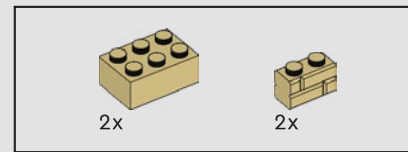
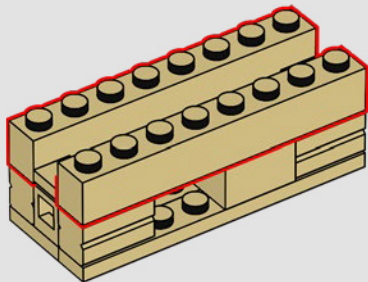

481

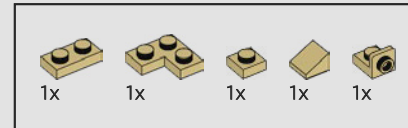
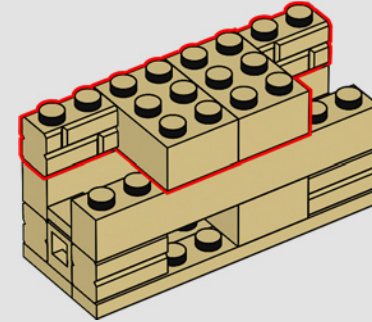

482

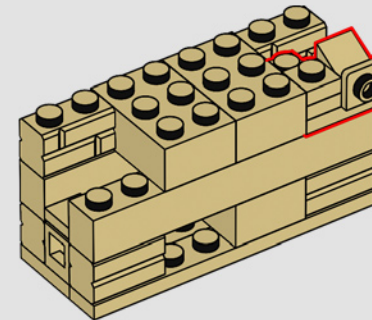
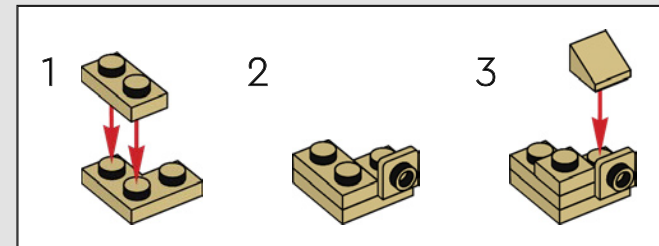

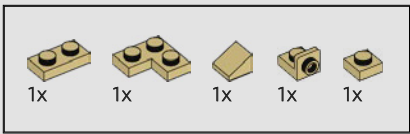

483

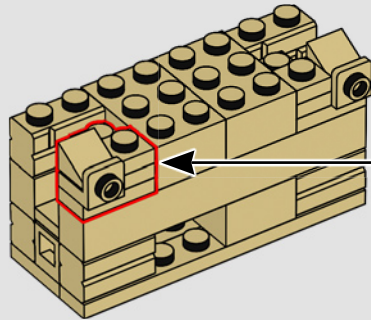
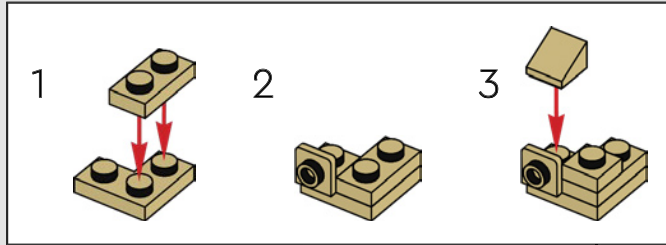

484

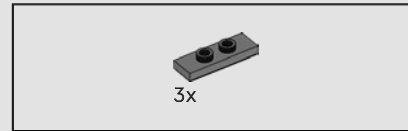
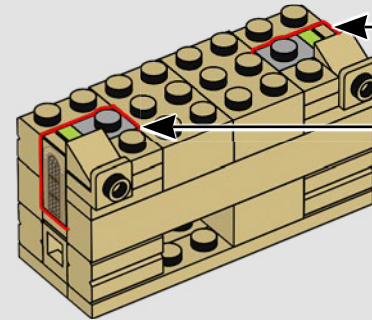
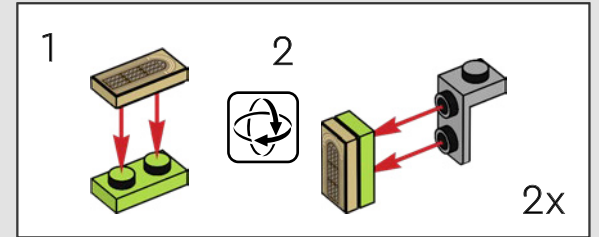

485

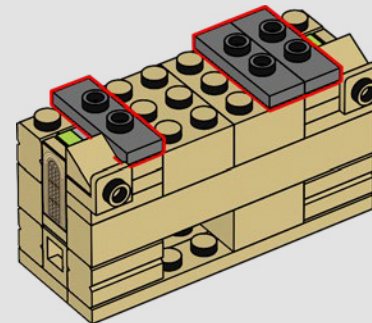

486



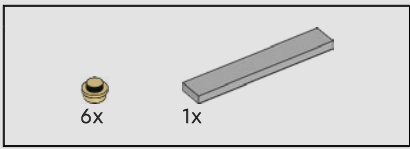

487

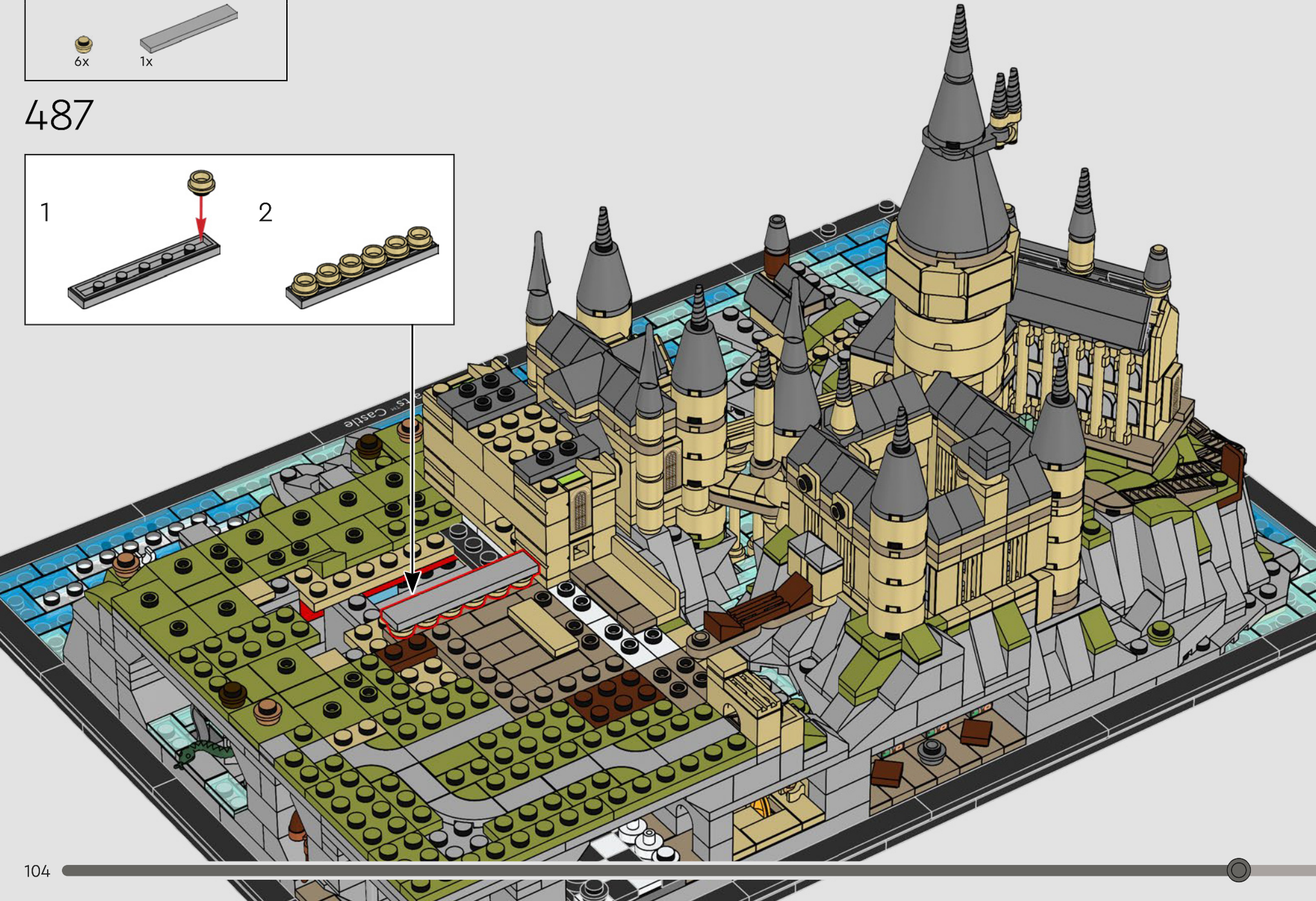
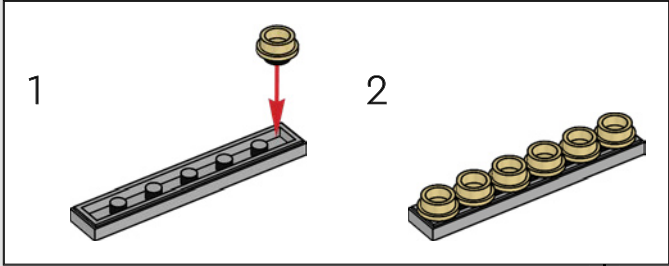

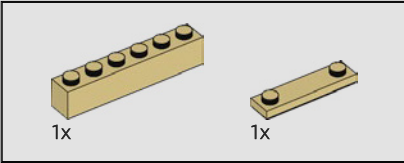
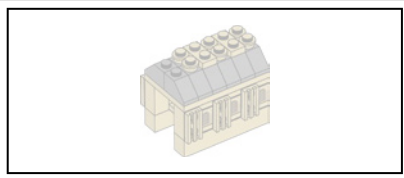

488

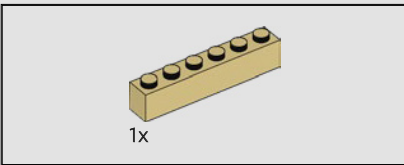
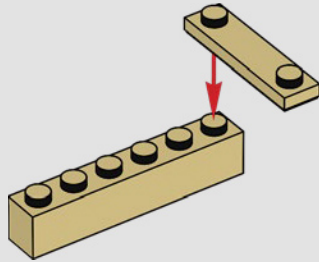

489

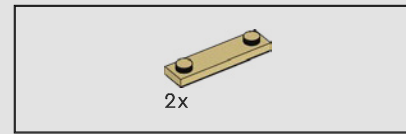
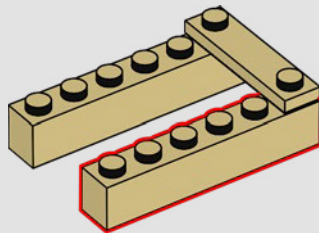

490

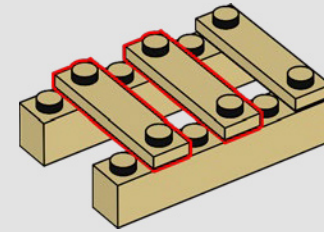

491

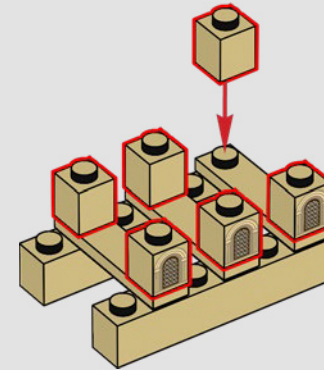

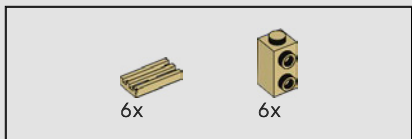

492

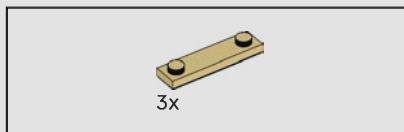
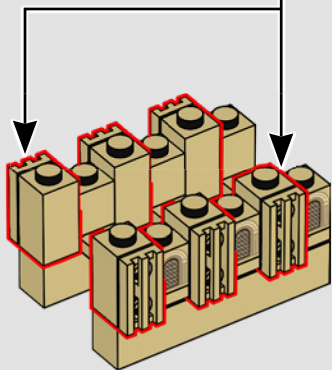
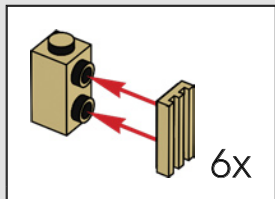

493

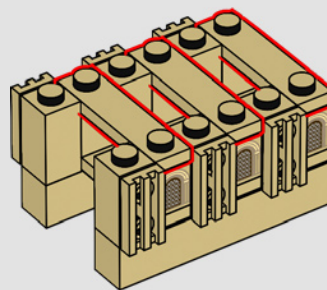

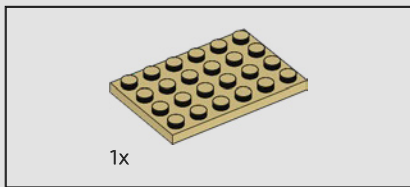

494

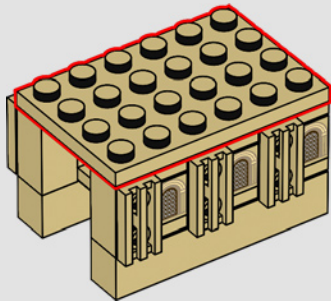

495

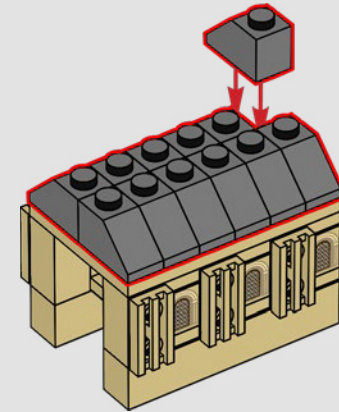

496

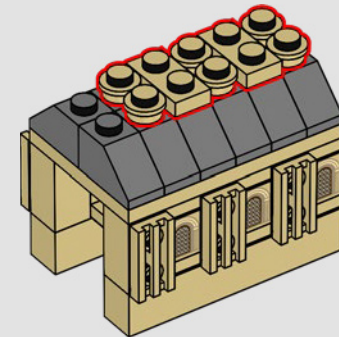

497

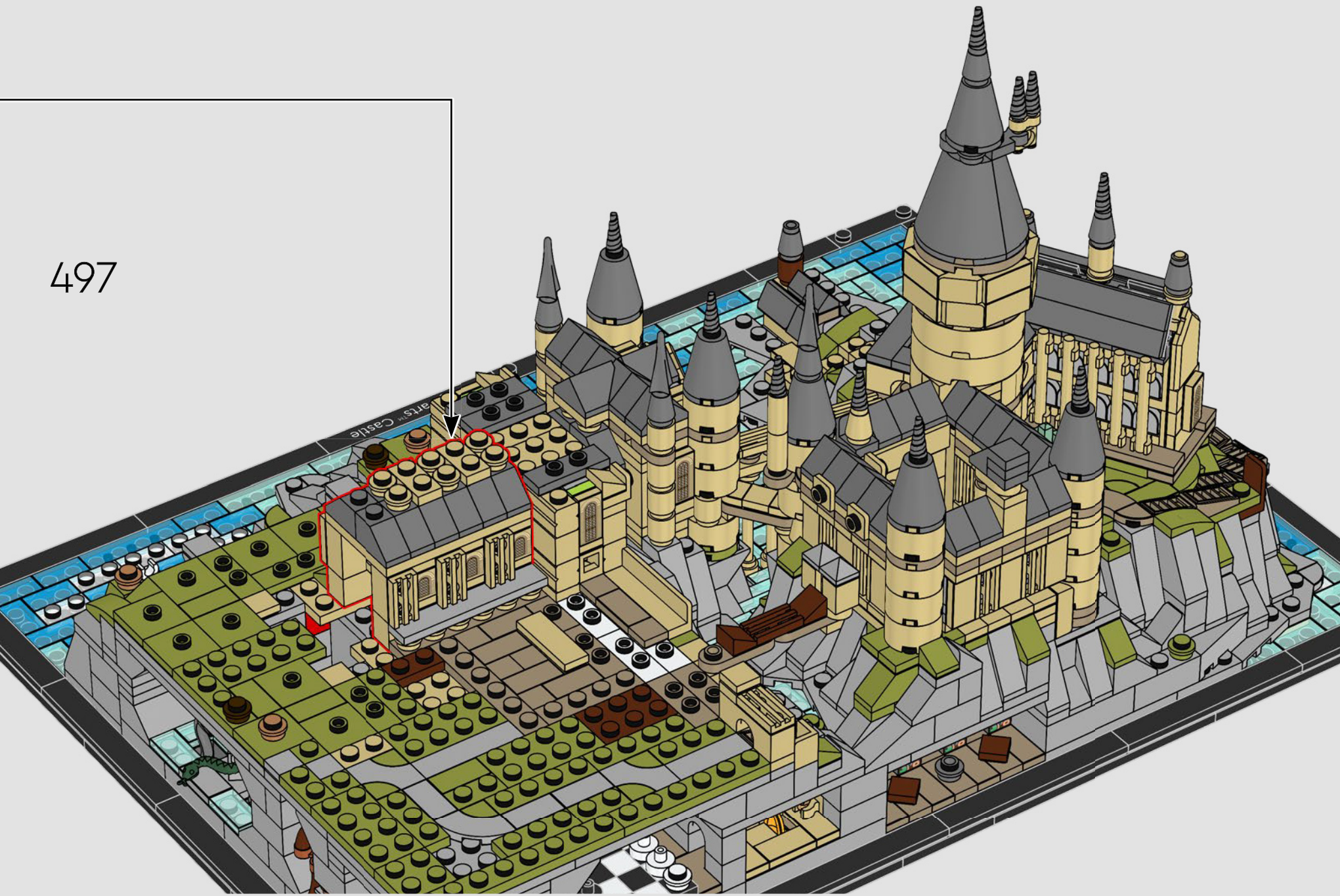

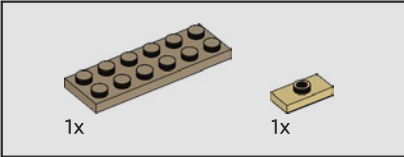
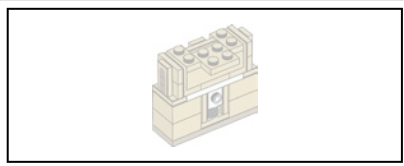

498

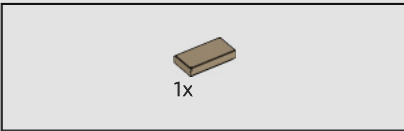
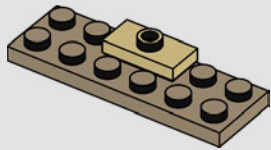

499

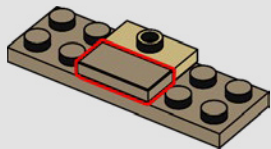

500

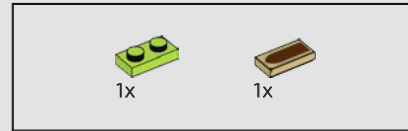
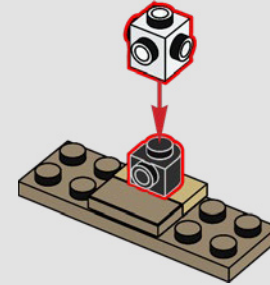

501

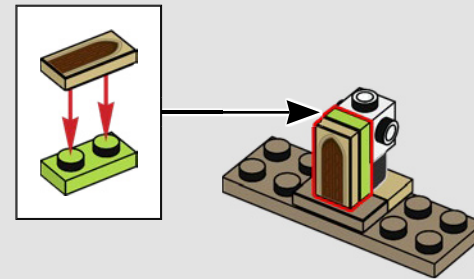

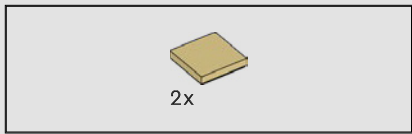

502

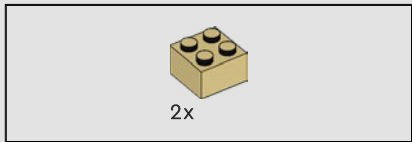
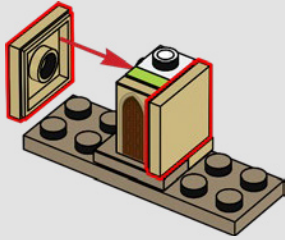

503

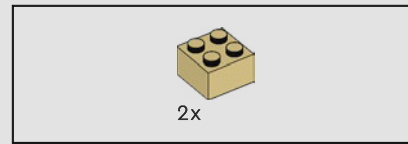
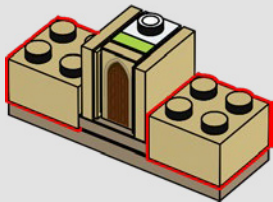

504

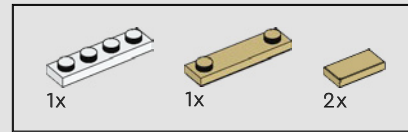
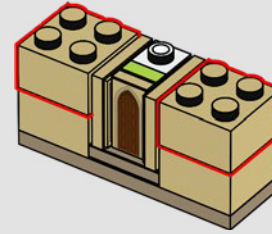

505

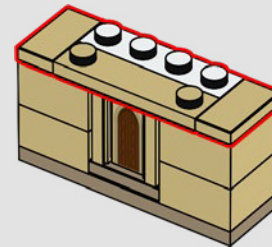

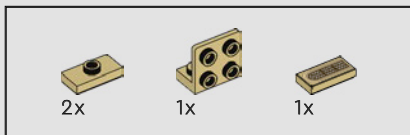

506

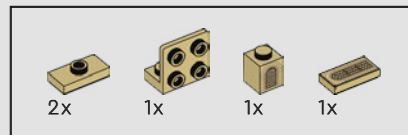
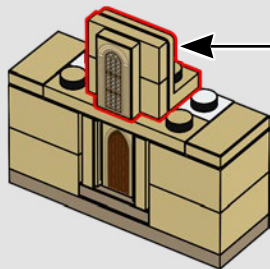
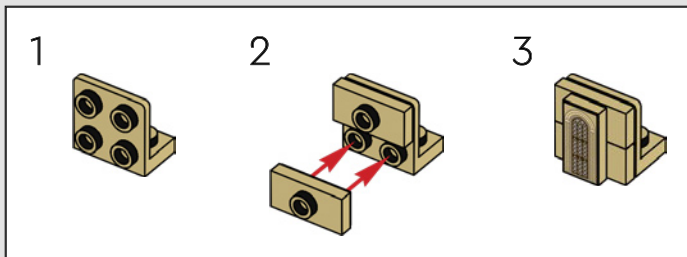

507

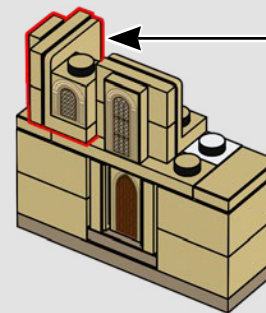
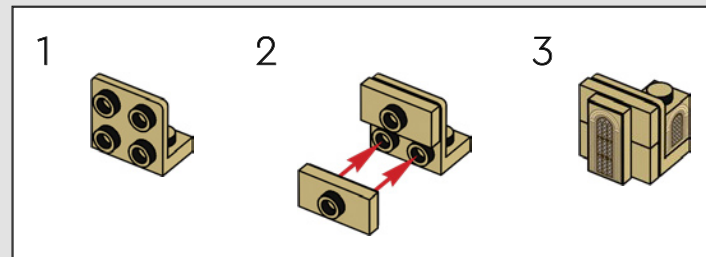

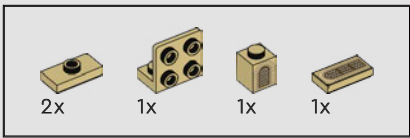

508

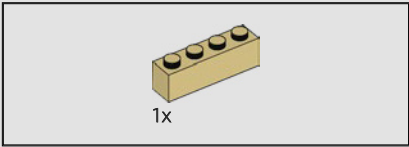
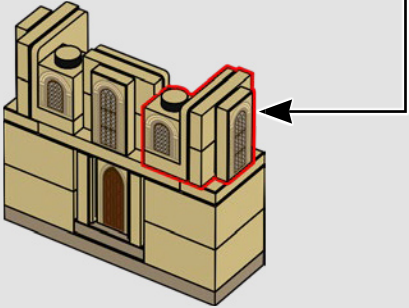
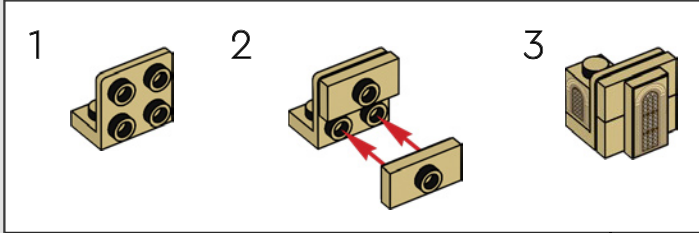

509

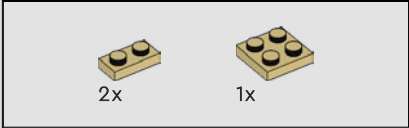
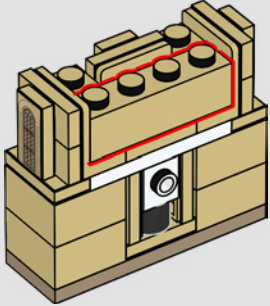

510

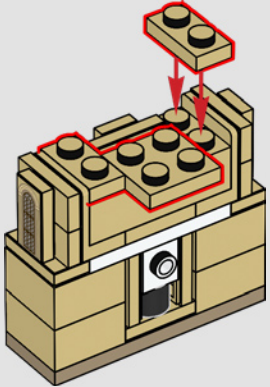

511





2x



2x



2x



2x



2x



2x



2x



2x



2x

512

1

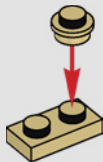

2

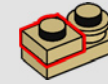

3

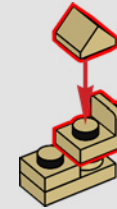

4

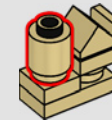

5

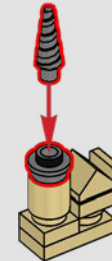

2x



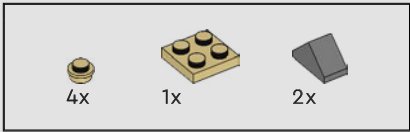

513

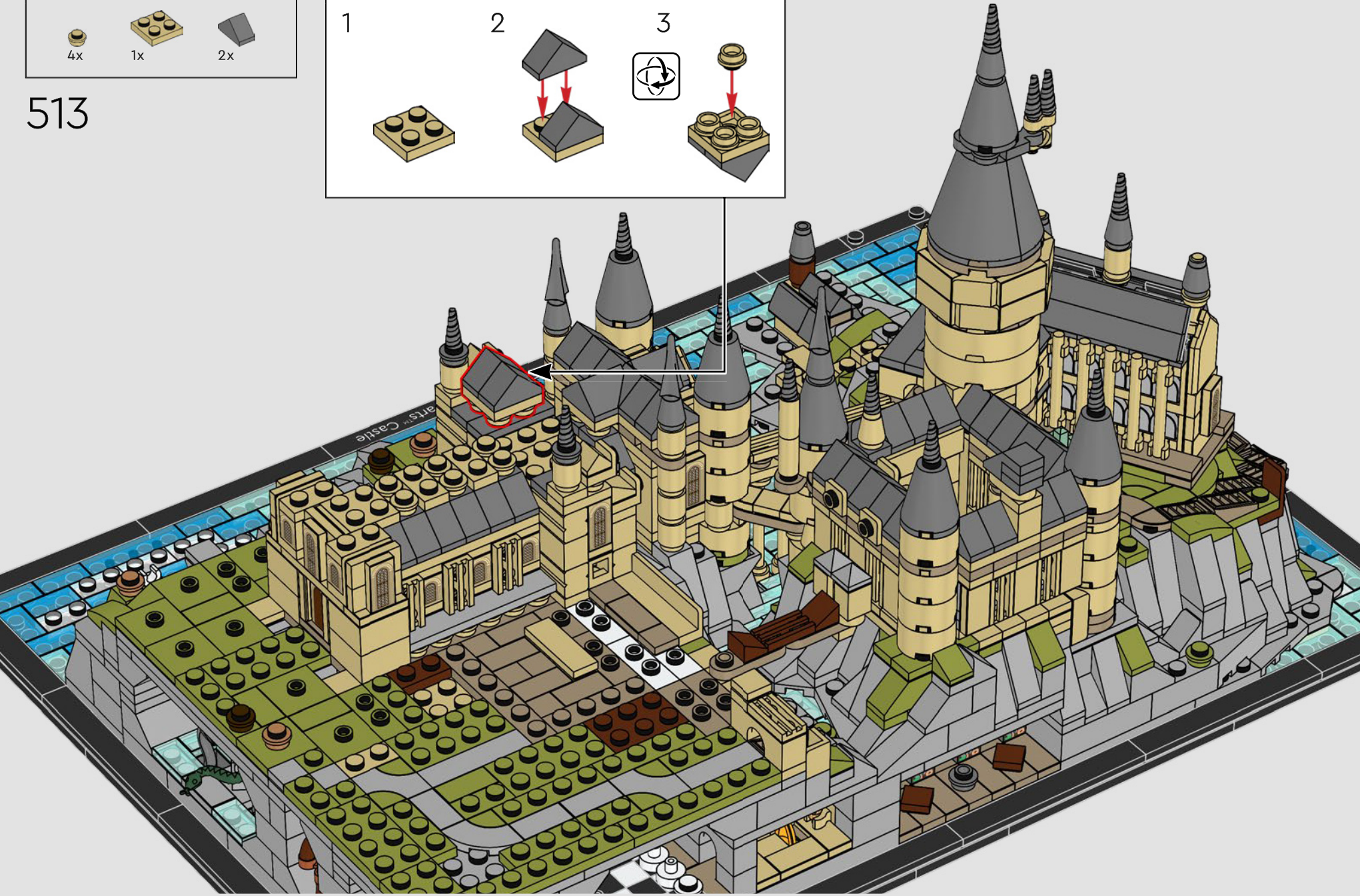
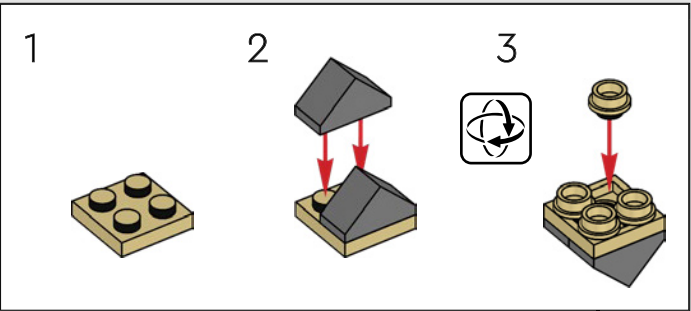

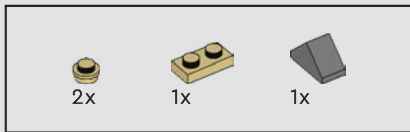

514

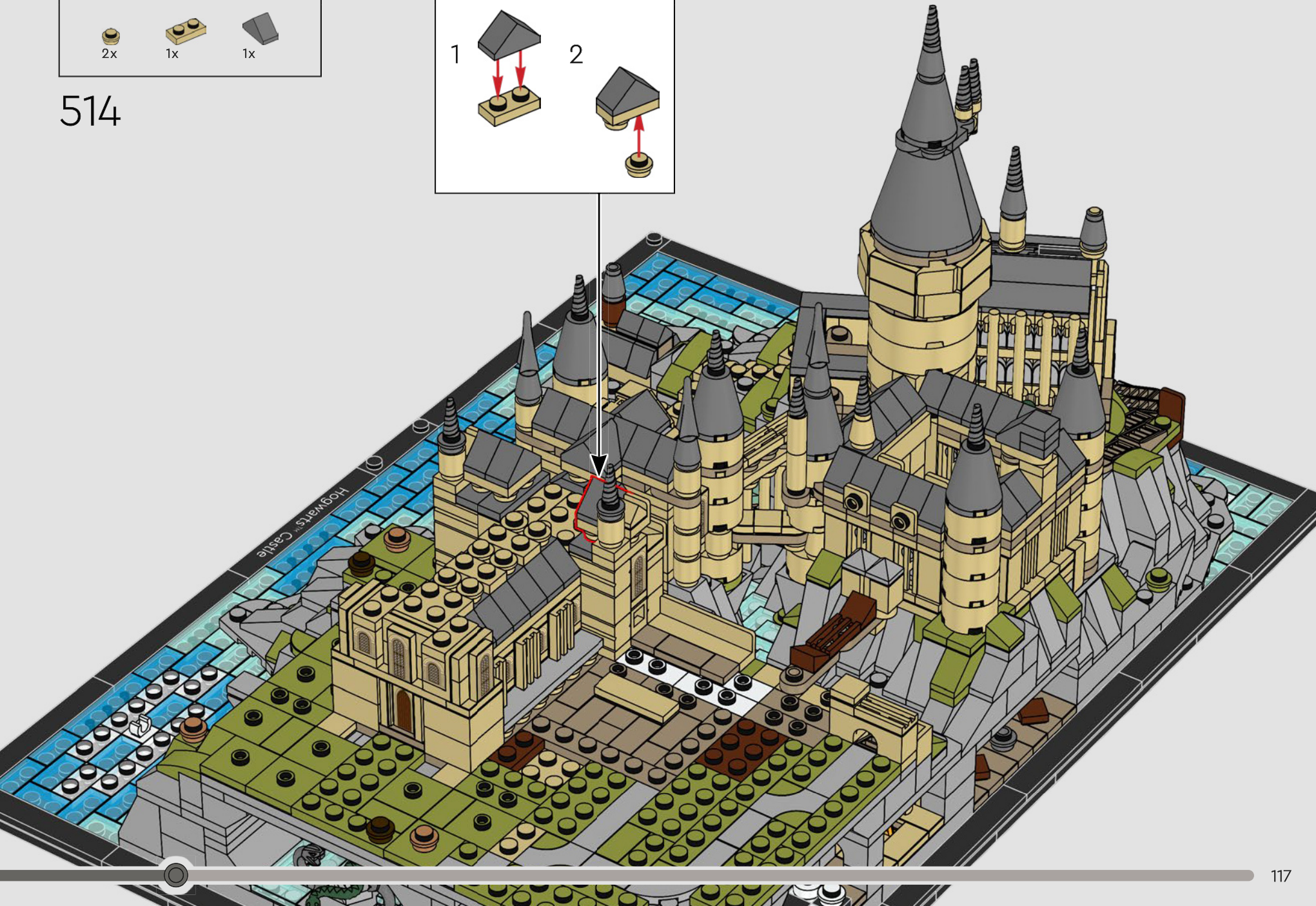
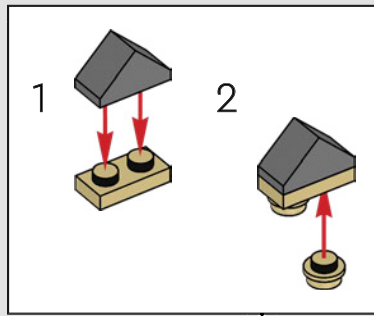

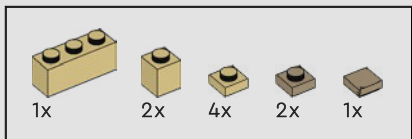

515

1

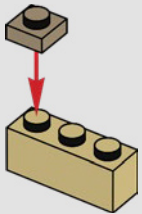

2

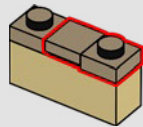

3

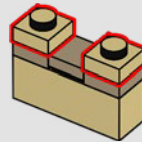

4

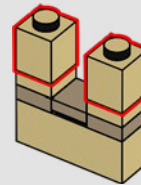

5

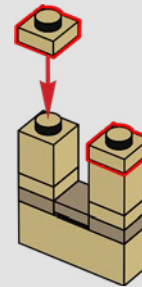

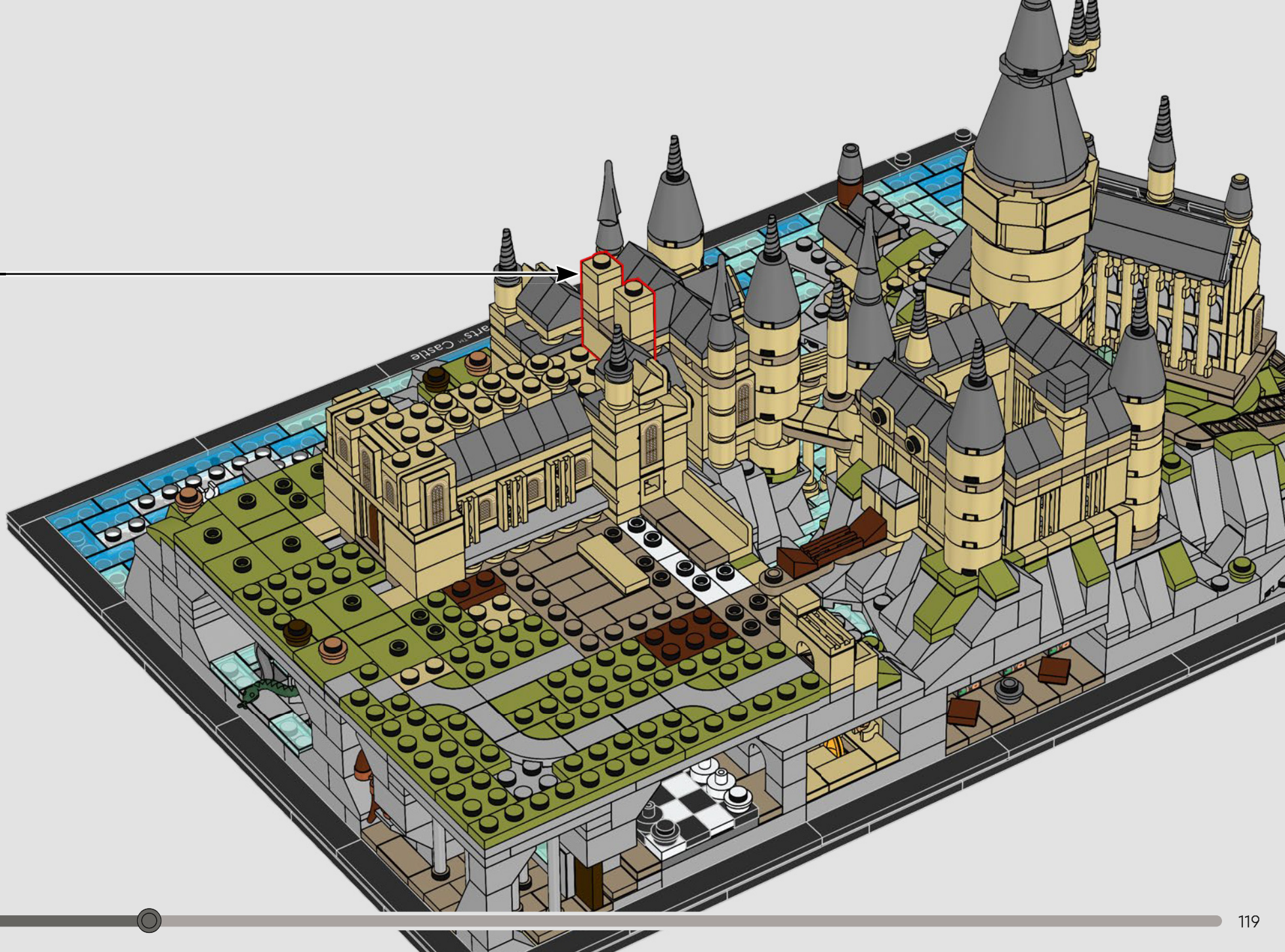

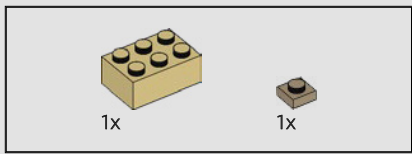

516

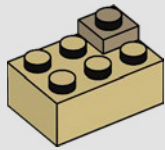

517

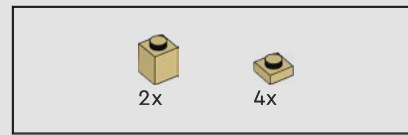
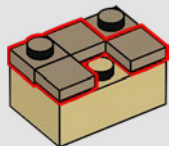

518

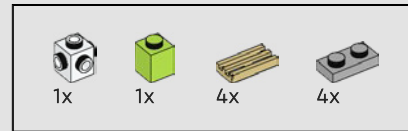
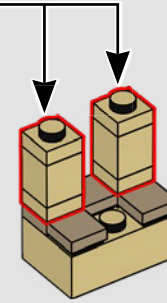
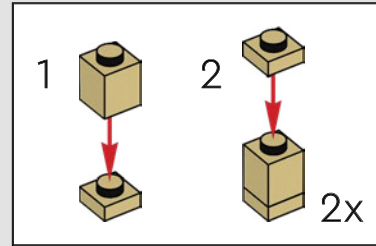

519

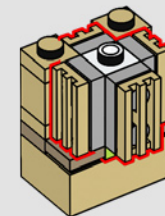
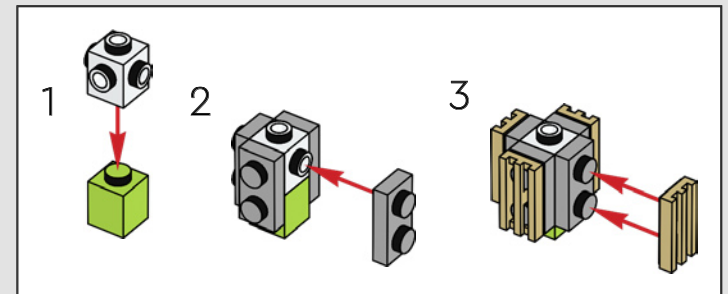

520

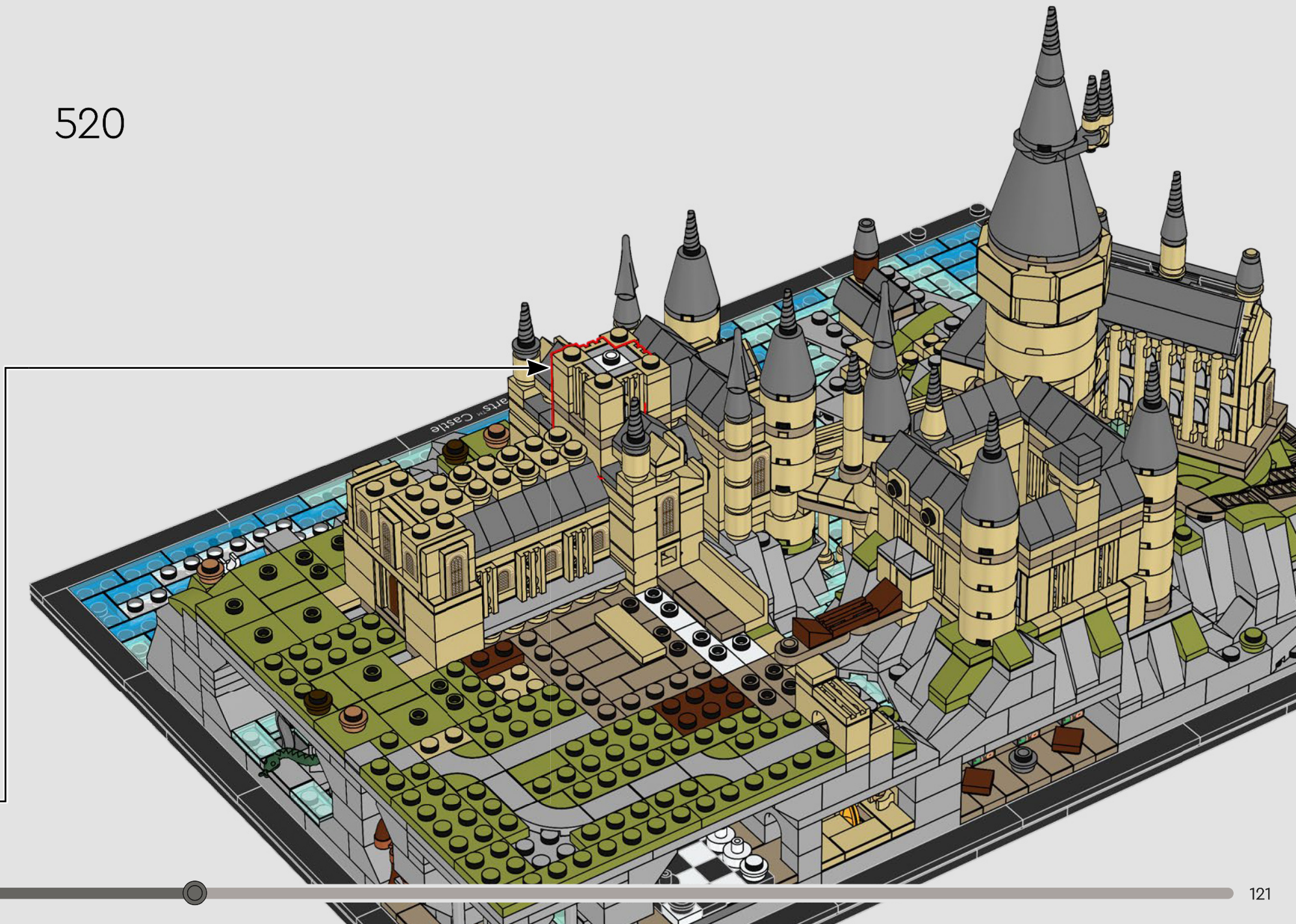

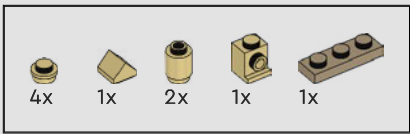

521

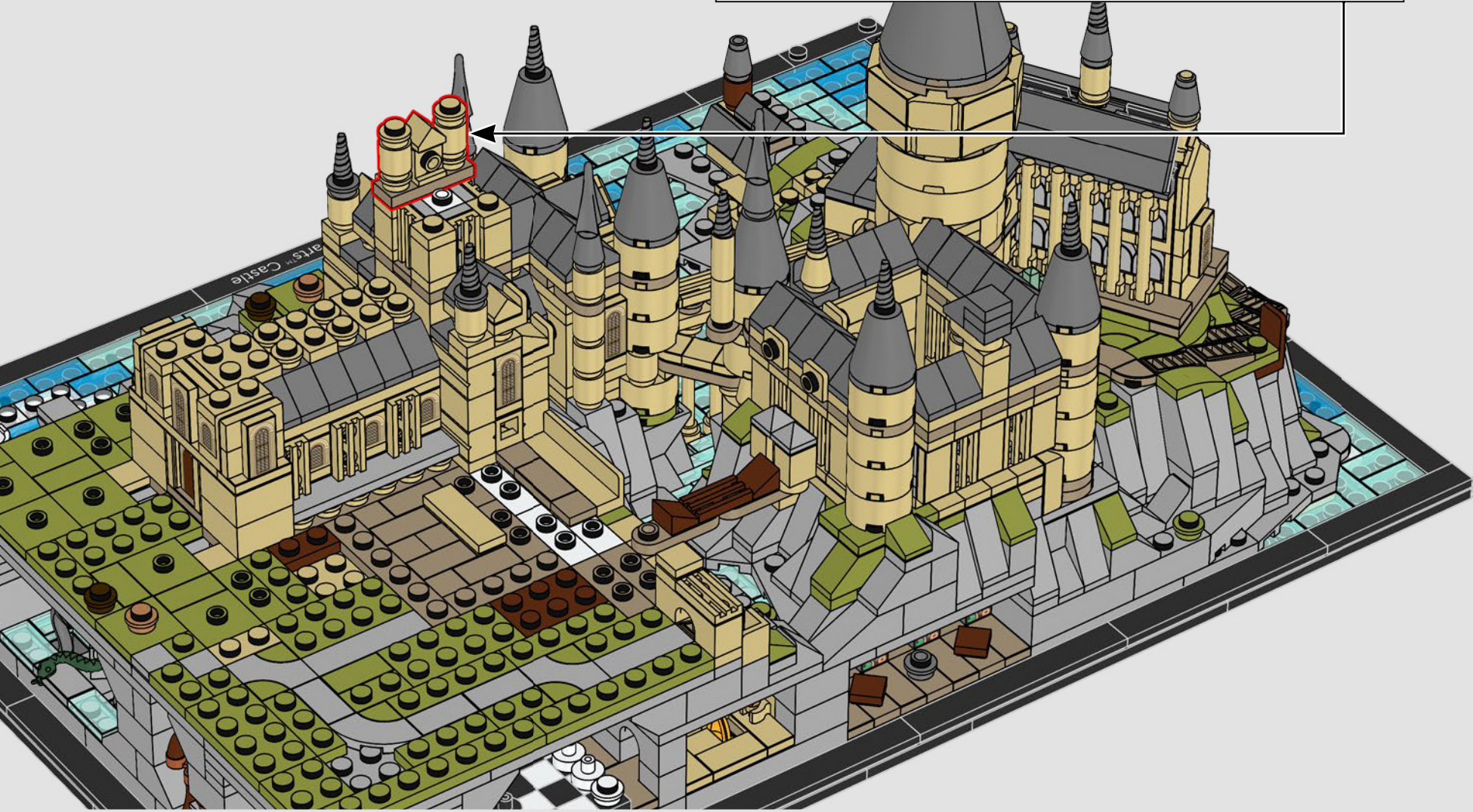
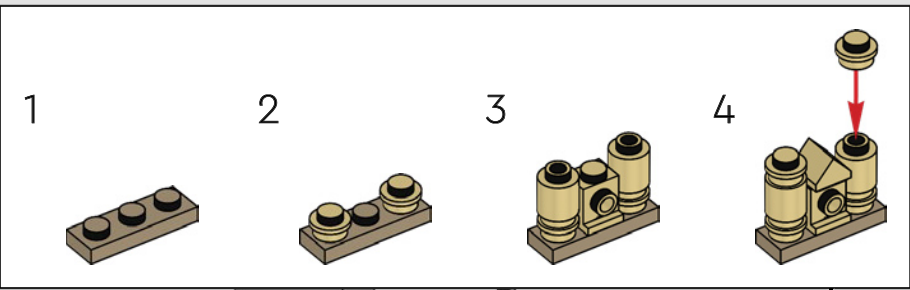

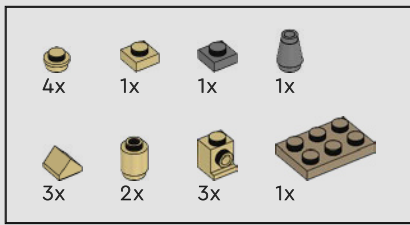

522

1

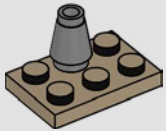

2

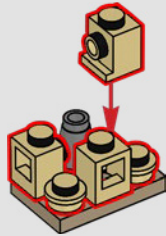

3

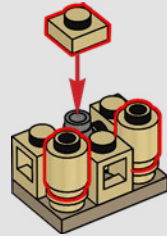

4

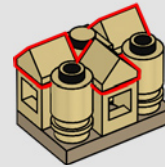

5

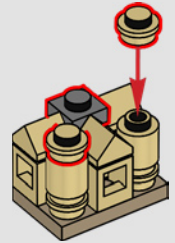

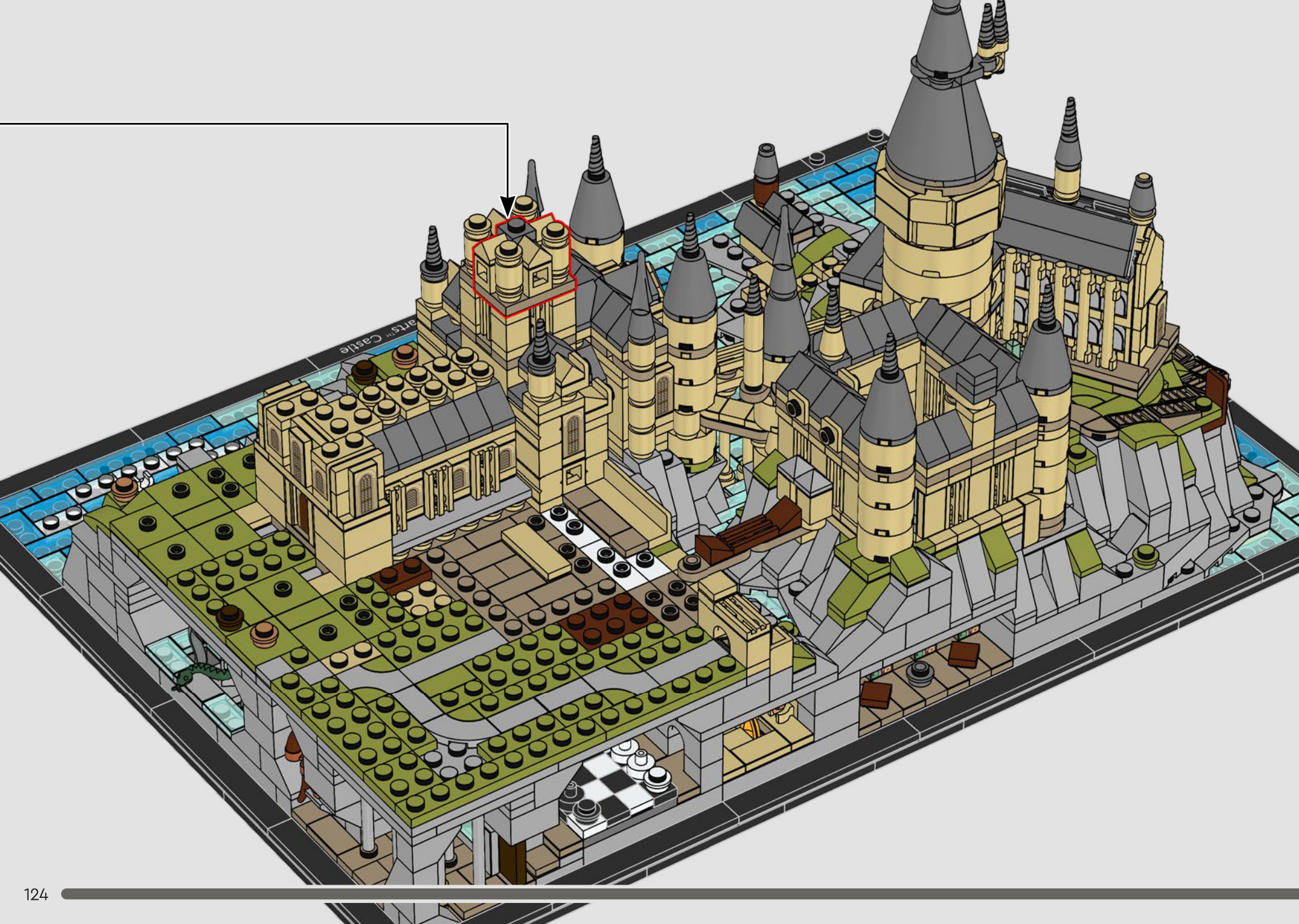

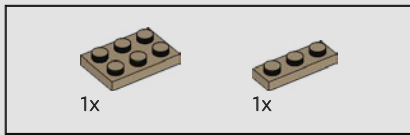

523



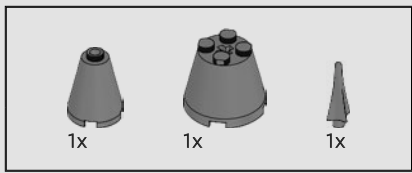

524

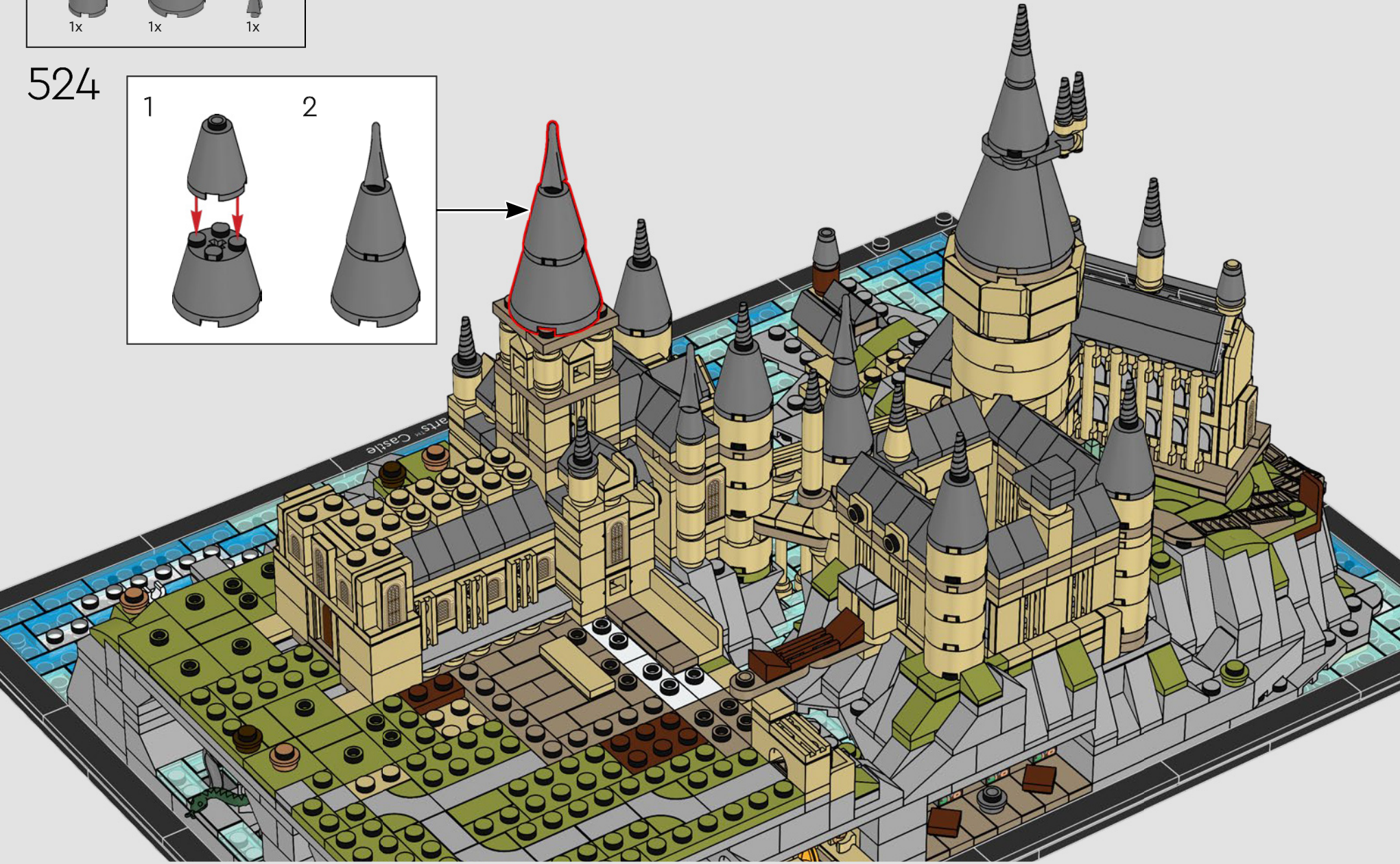
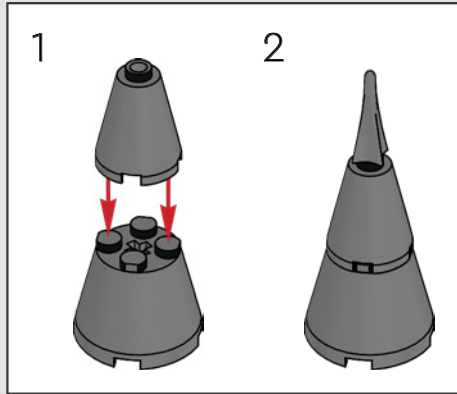

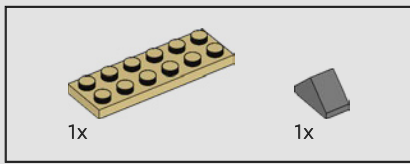

525

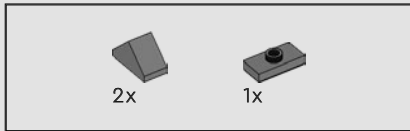
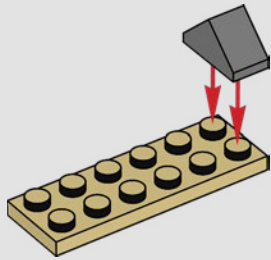

526

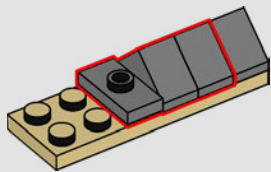

527

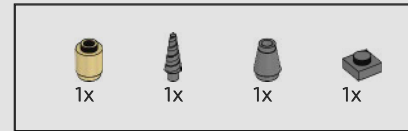
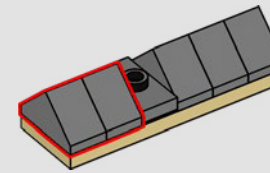

528

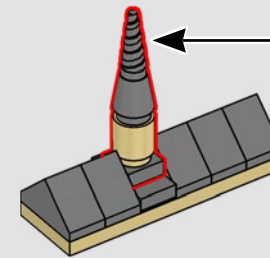
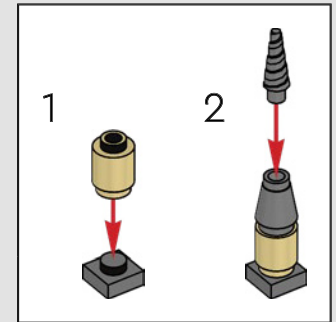

529

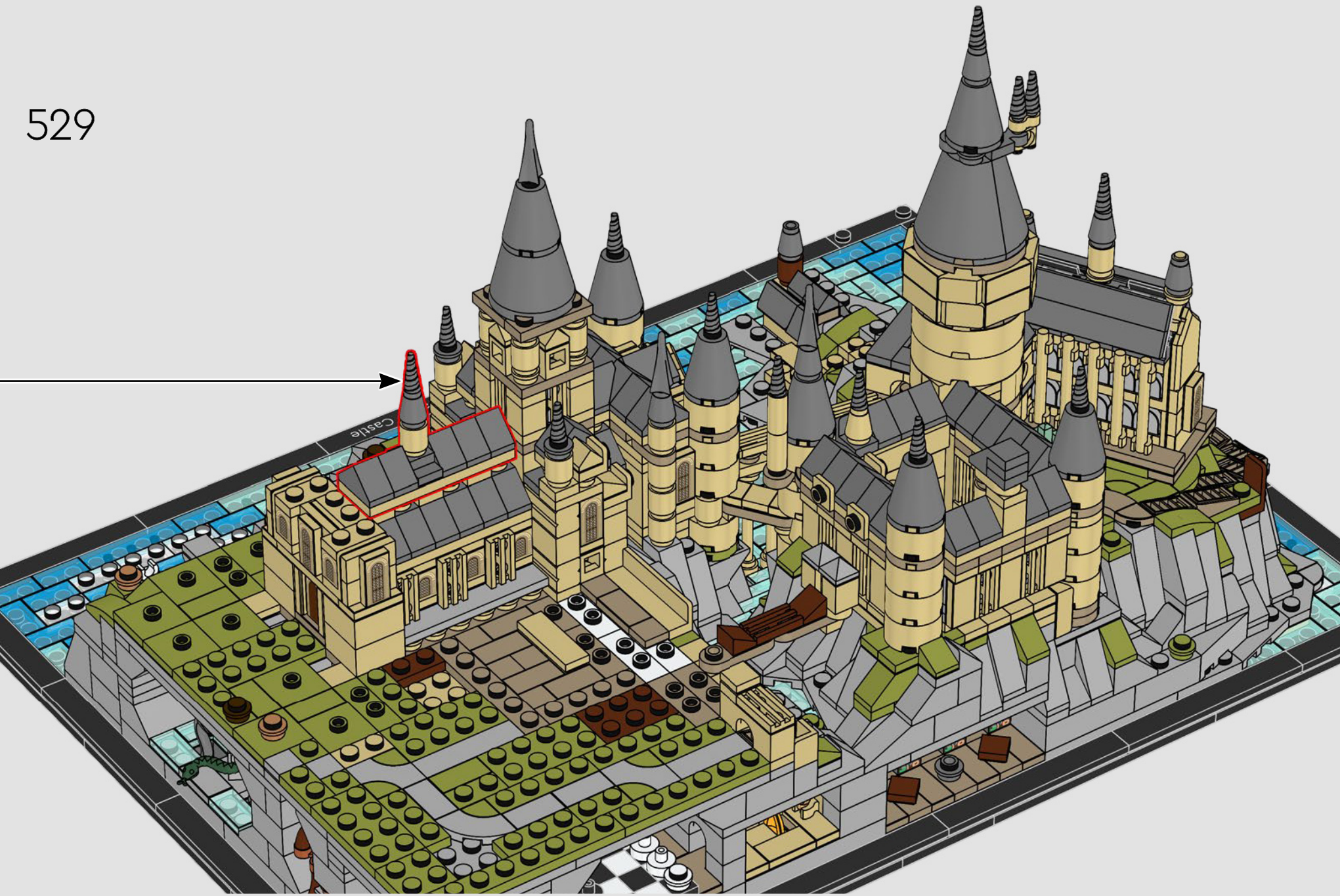

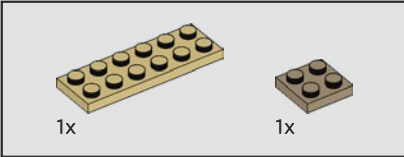
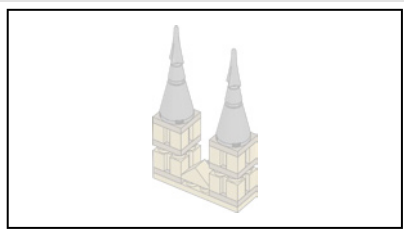

530

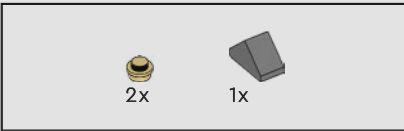
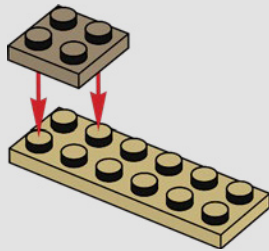

531

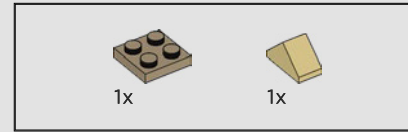
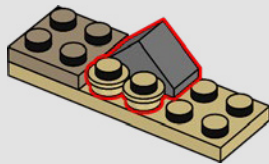

532

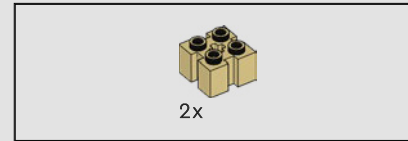
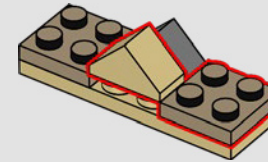

533

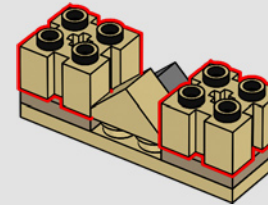



8x

534

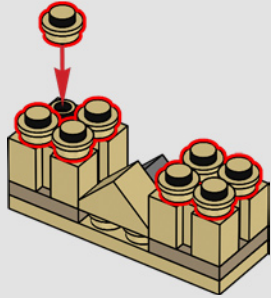

2x

535

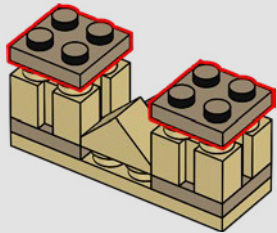

2x

536

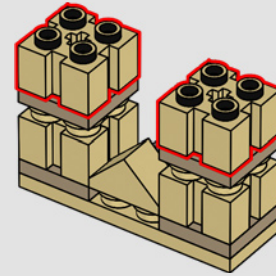

2x

537

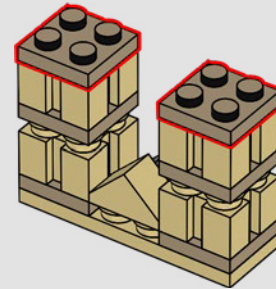

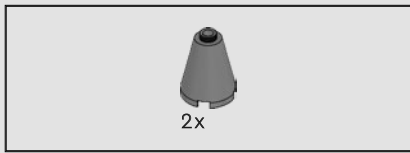

538

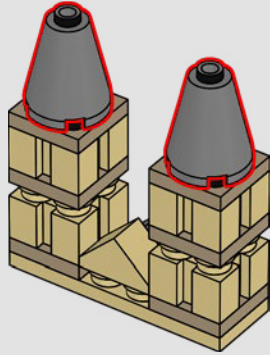

539

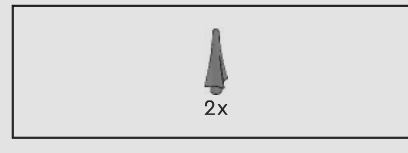
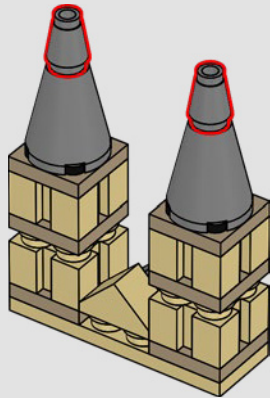

540

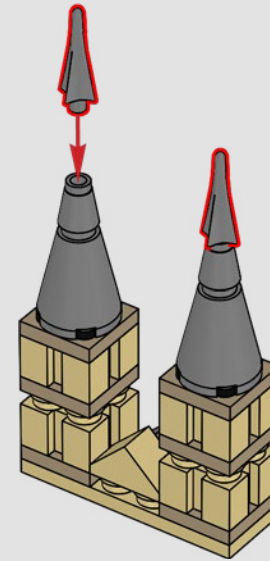

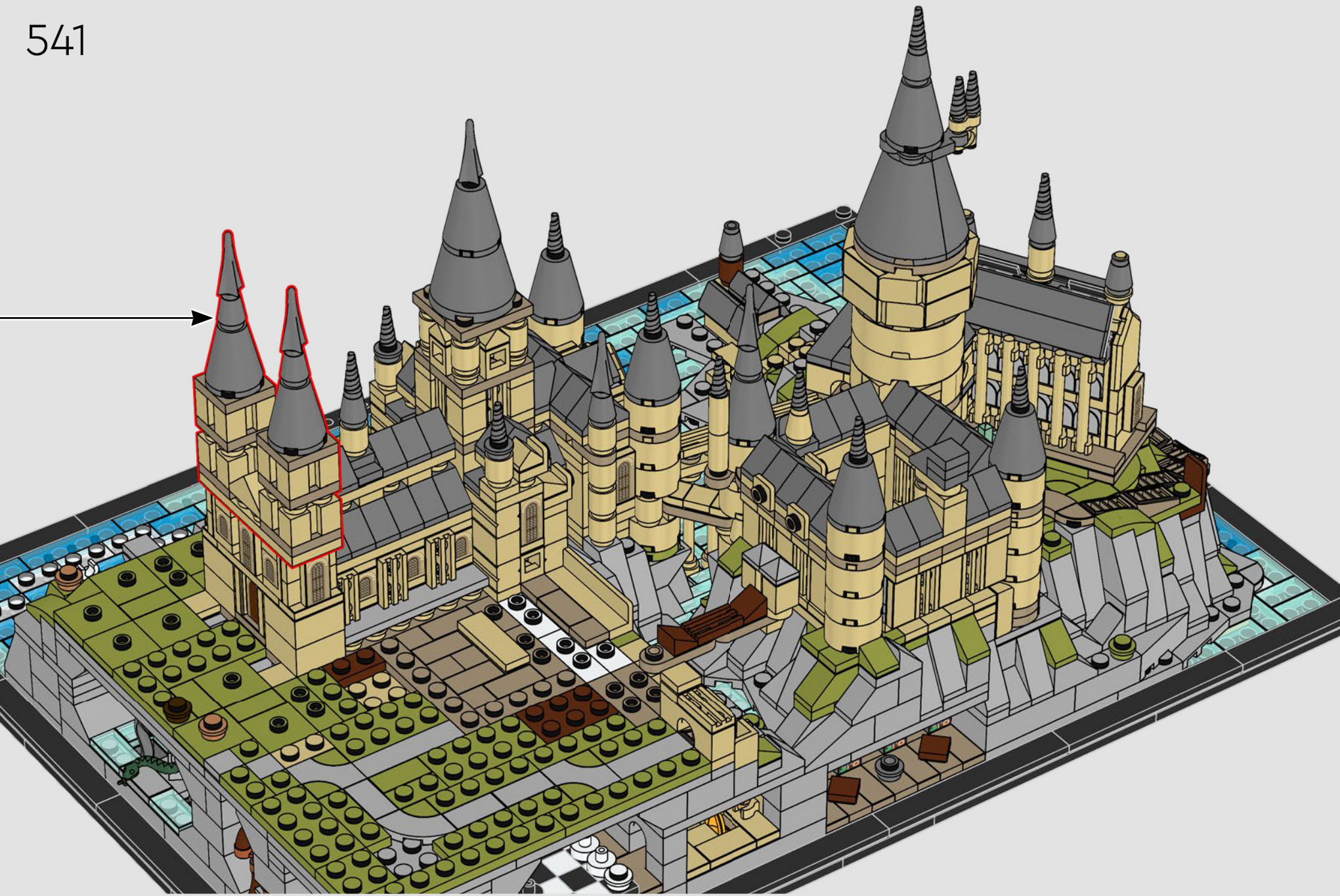

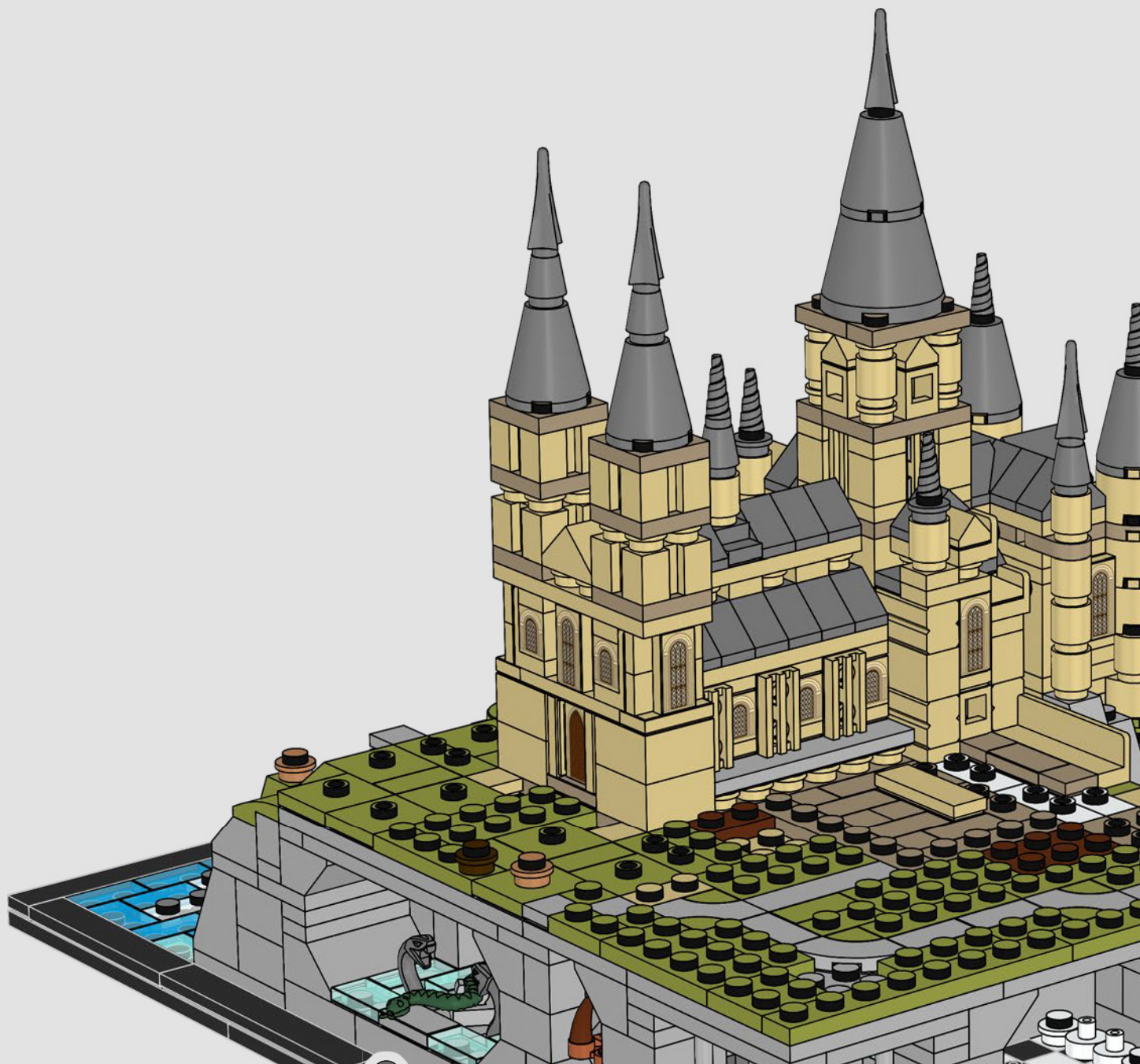

Quelles que soient les matières préférées des élèves de Poudlard, ils passeront inévitablement une grande partie de leur temps dans l'aile Est, où se trouvent de nombreuses salles de classe.





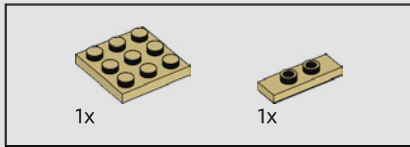
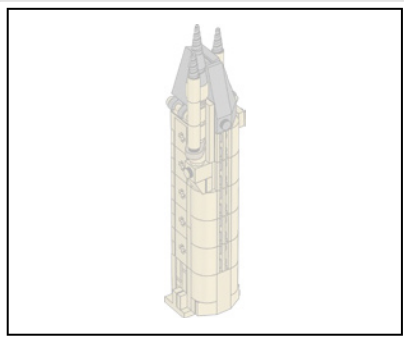

542

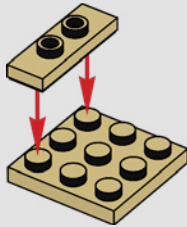

543

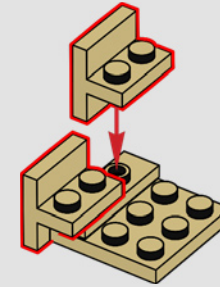

544

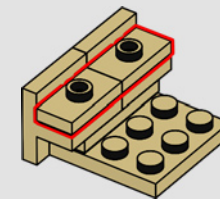



2x

545

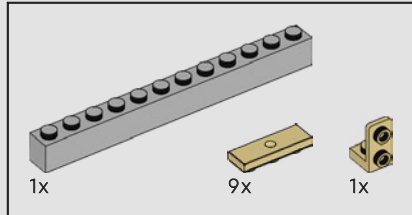
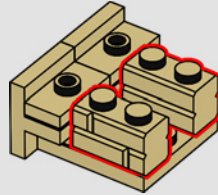

546

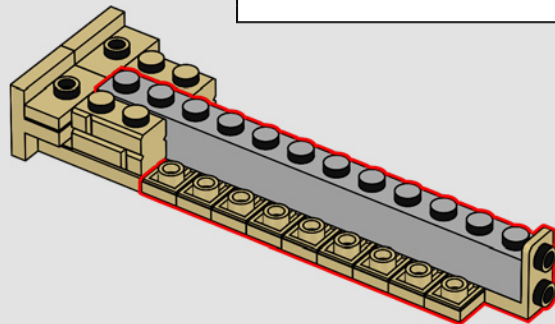
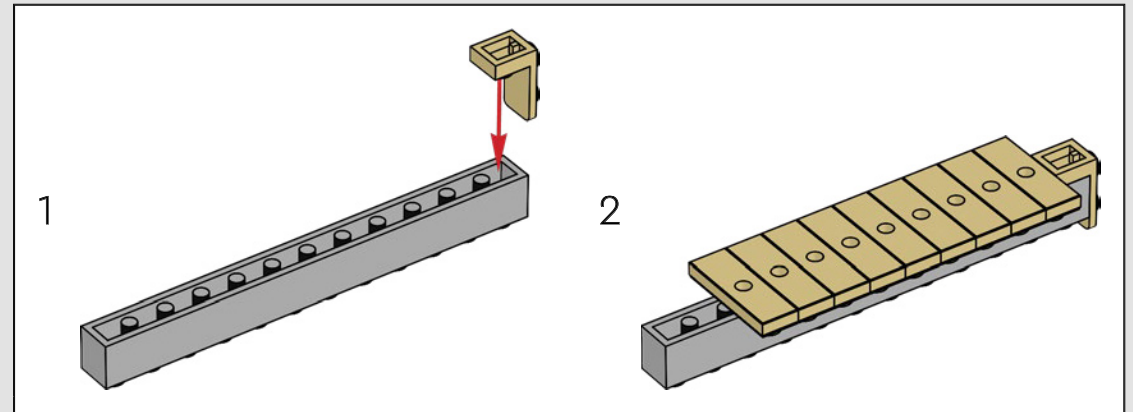

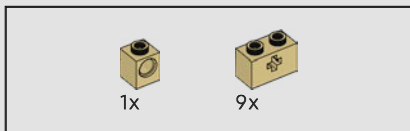

547

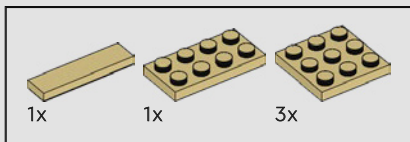
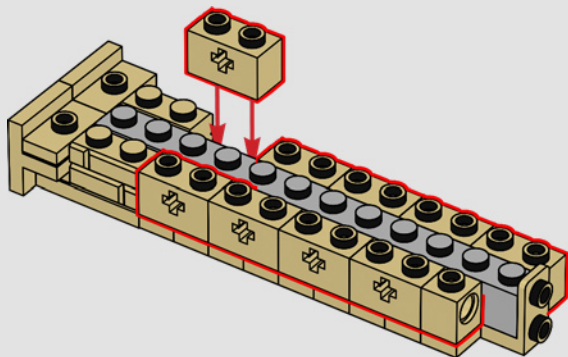

548

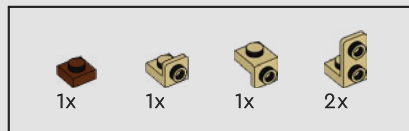
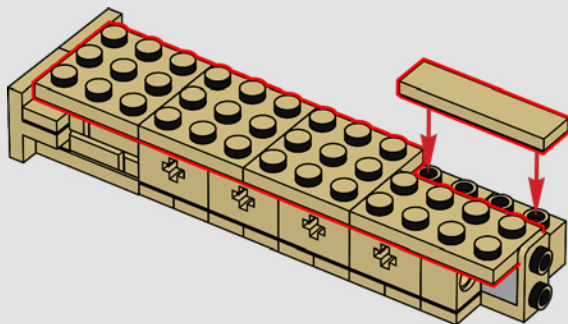

549

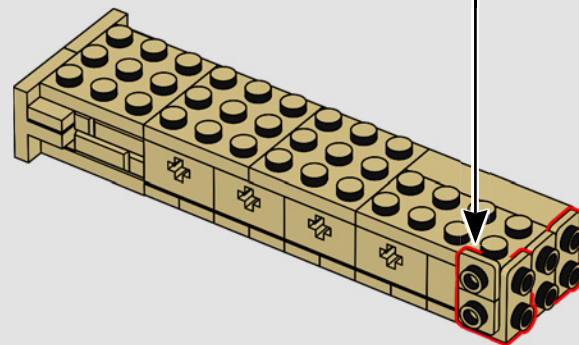
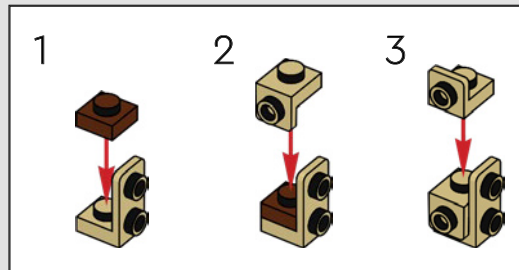

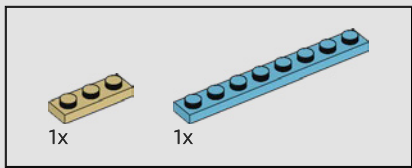

550

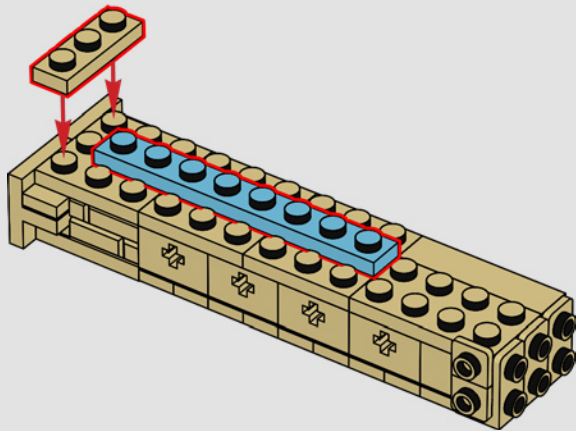

551

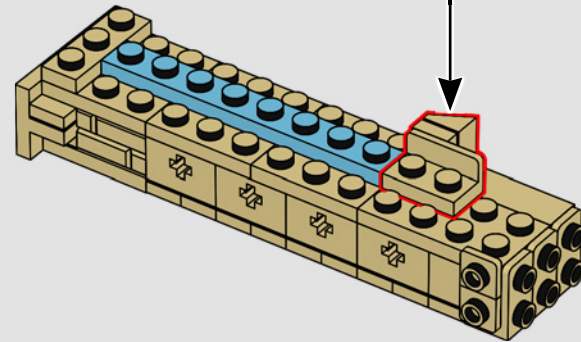
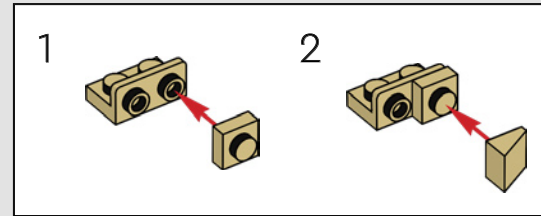

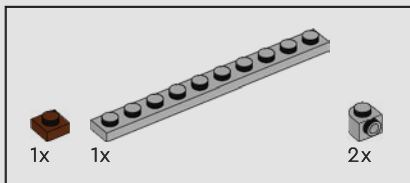

552

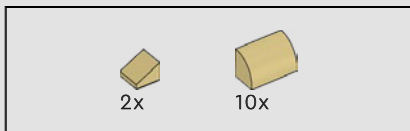
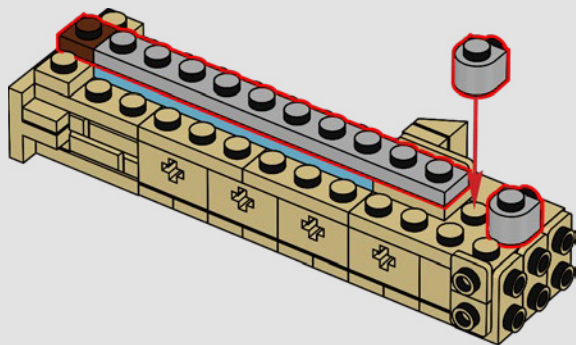

553

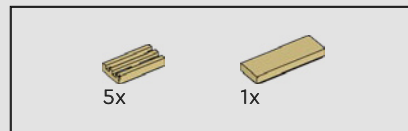
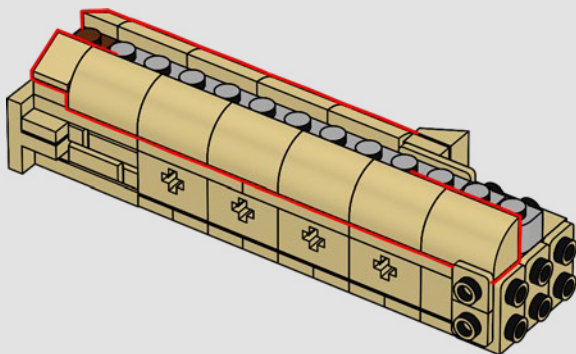

554

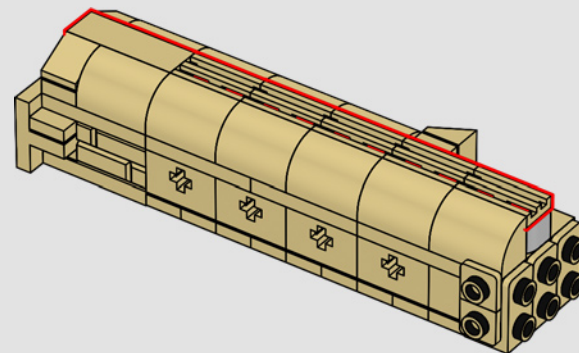



1x

555

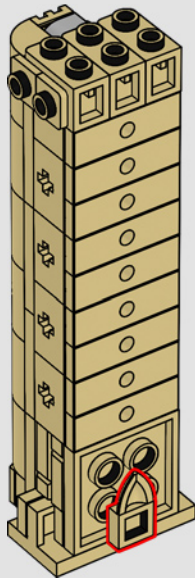

2x

556

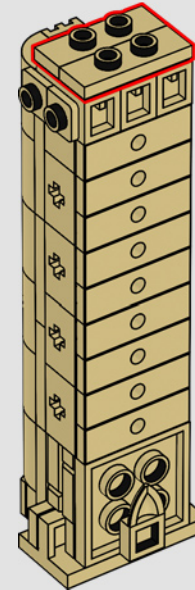

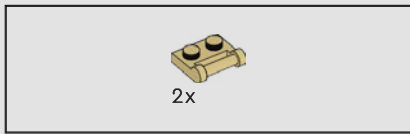

557

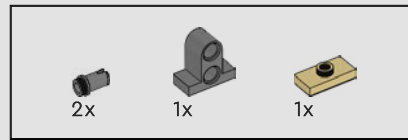
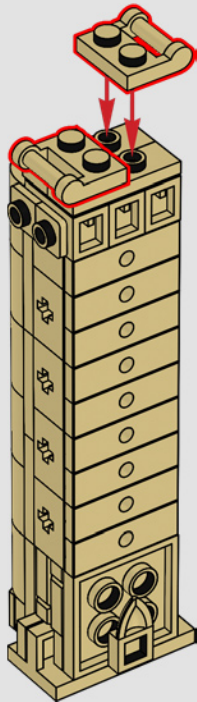

558

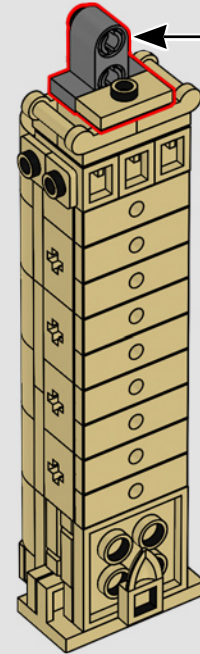
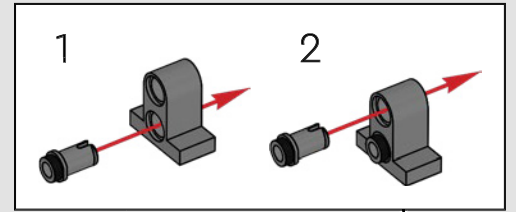



559

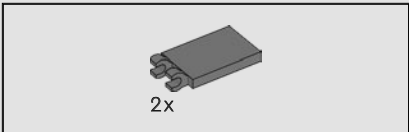

560

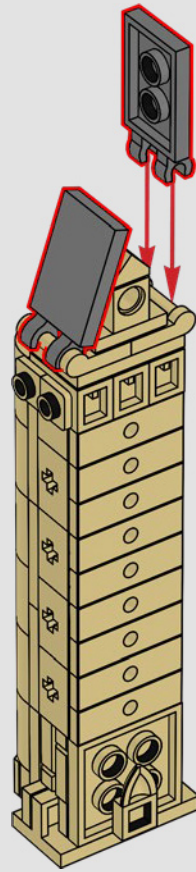



561

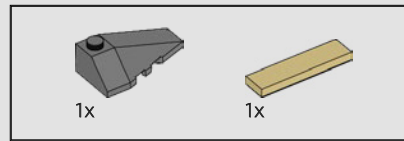
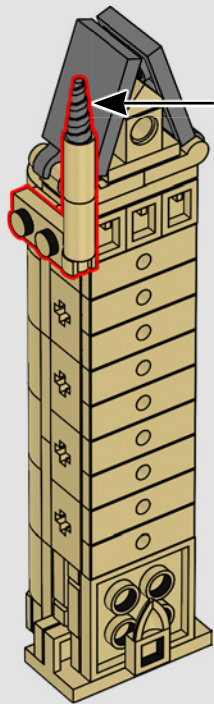
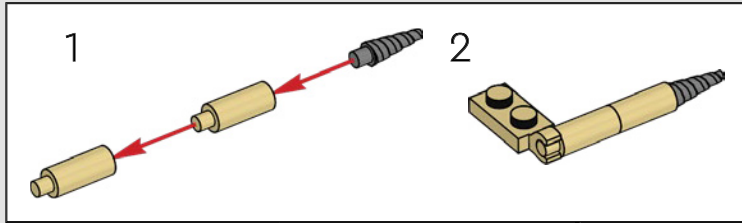

562

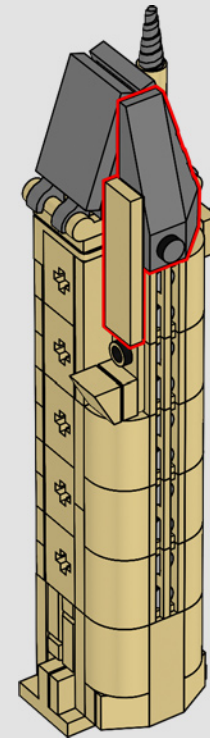
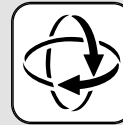

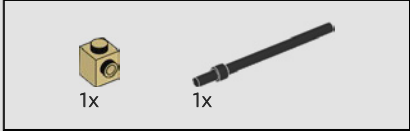
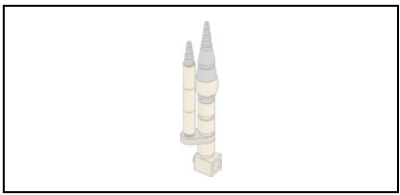

563

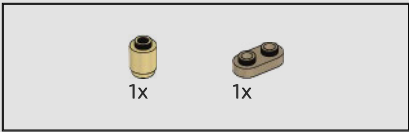

564



565





566

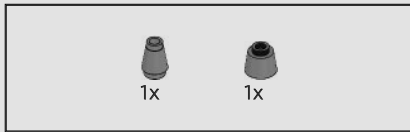

567

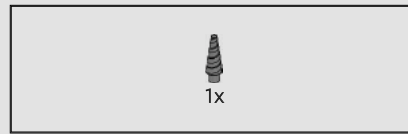
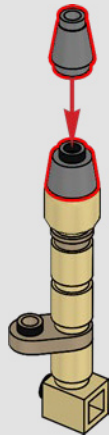

568

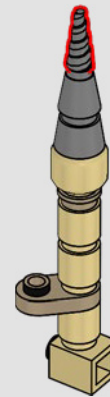

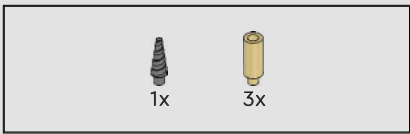

569

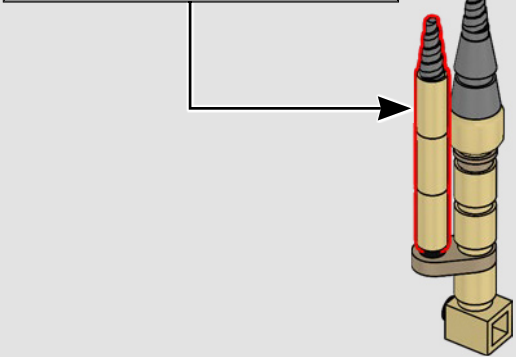
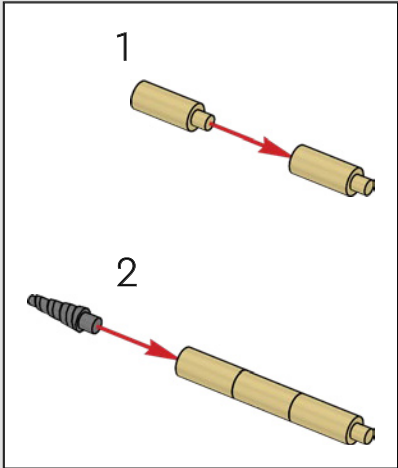

570

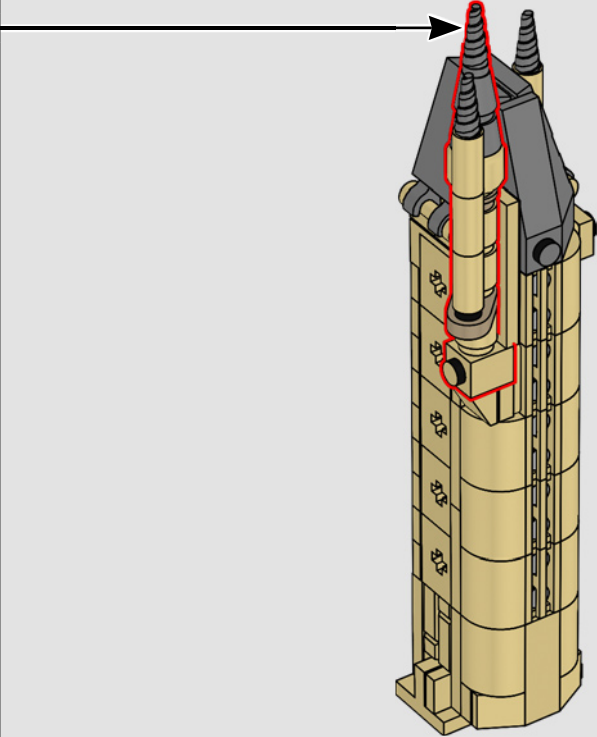

571

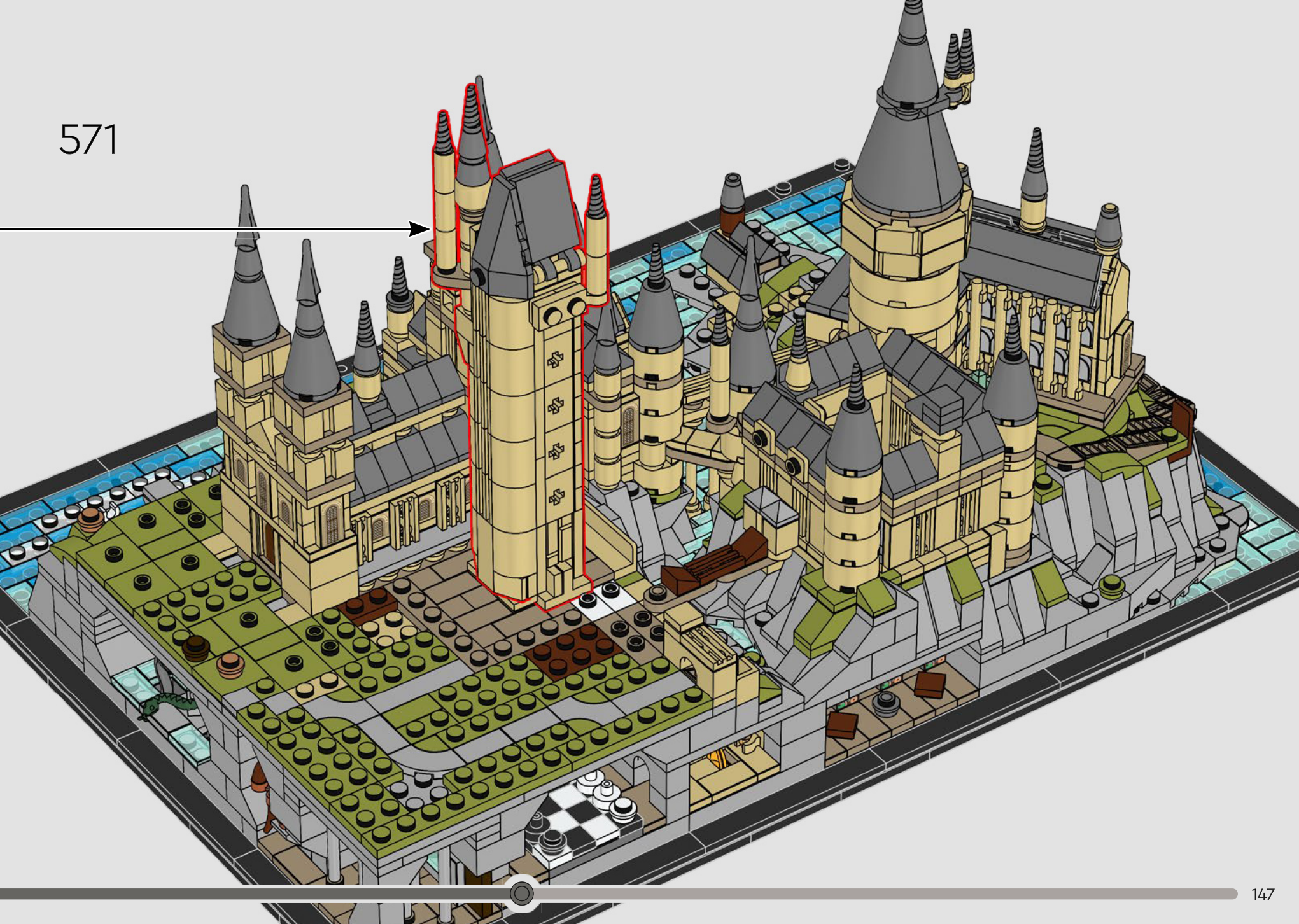

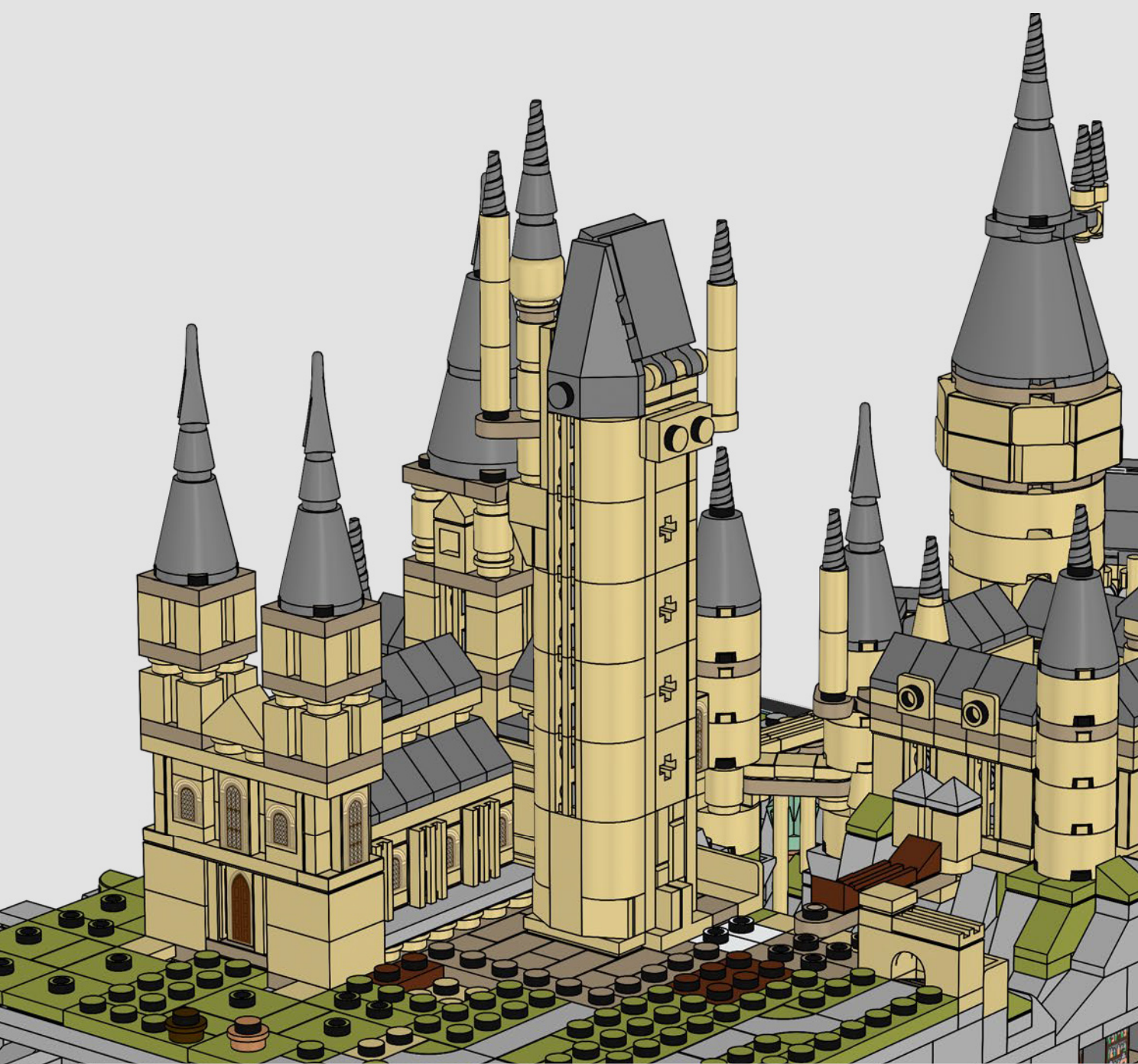

Vous pensiez peut-être
que le point culminant
du château de Poudlard
était la tour principale,
alors qu'en fait c'est la
tour d'astronomie.



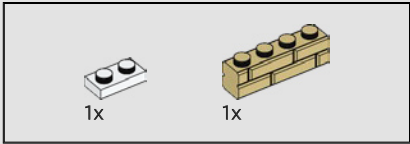
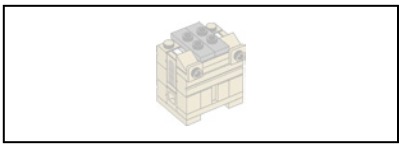

572

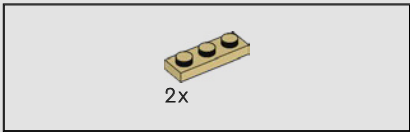
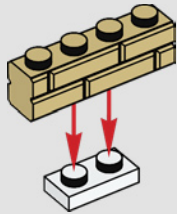

573

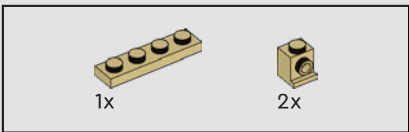
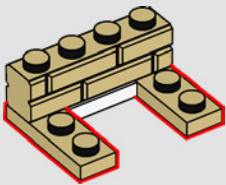

574

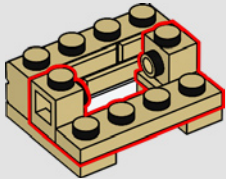

575

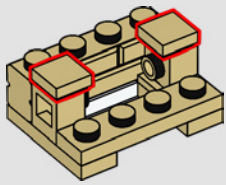

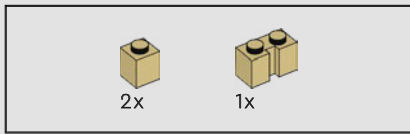

576

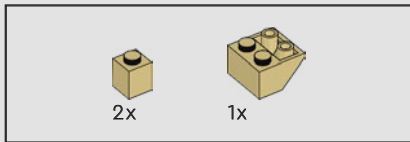
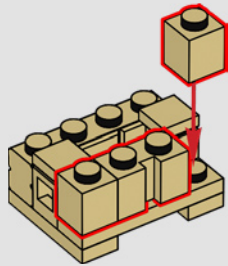

577

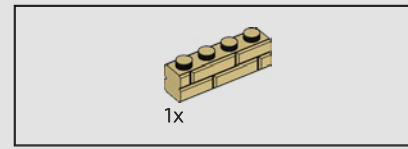
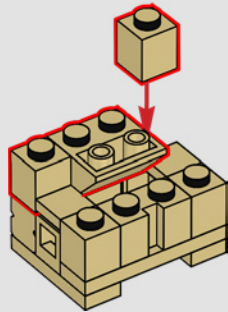

578

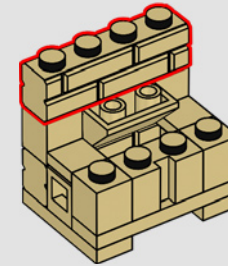

579

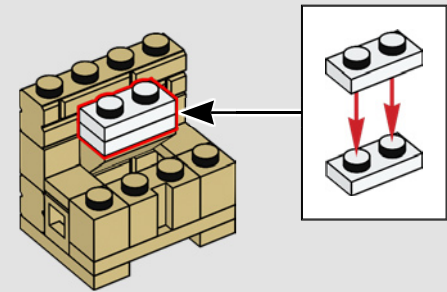

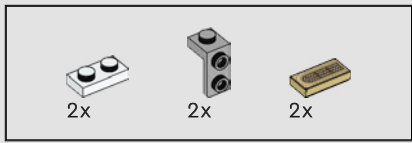

580

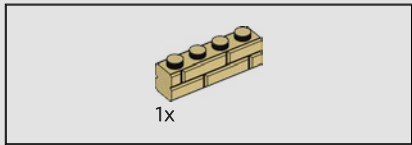
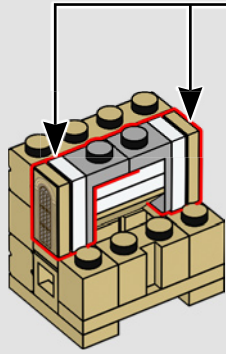
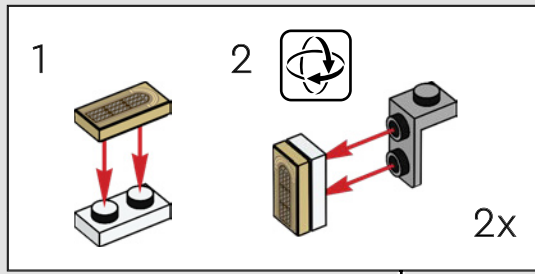

581

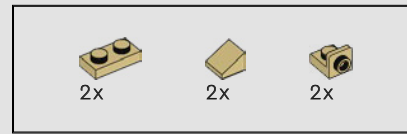
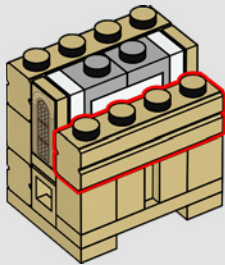

582

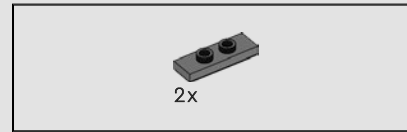
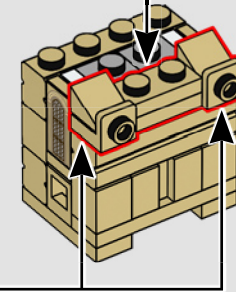
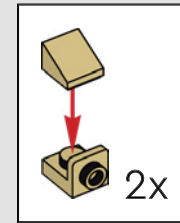
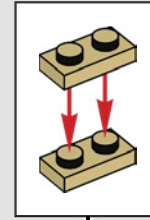

583

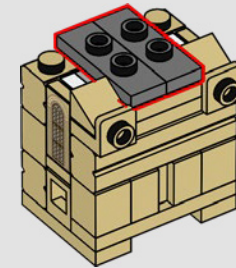

584

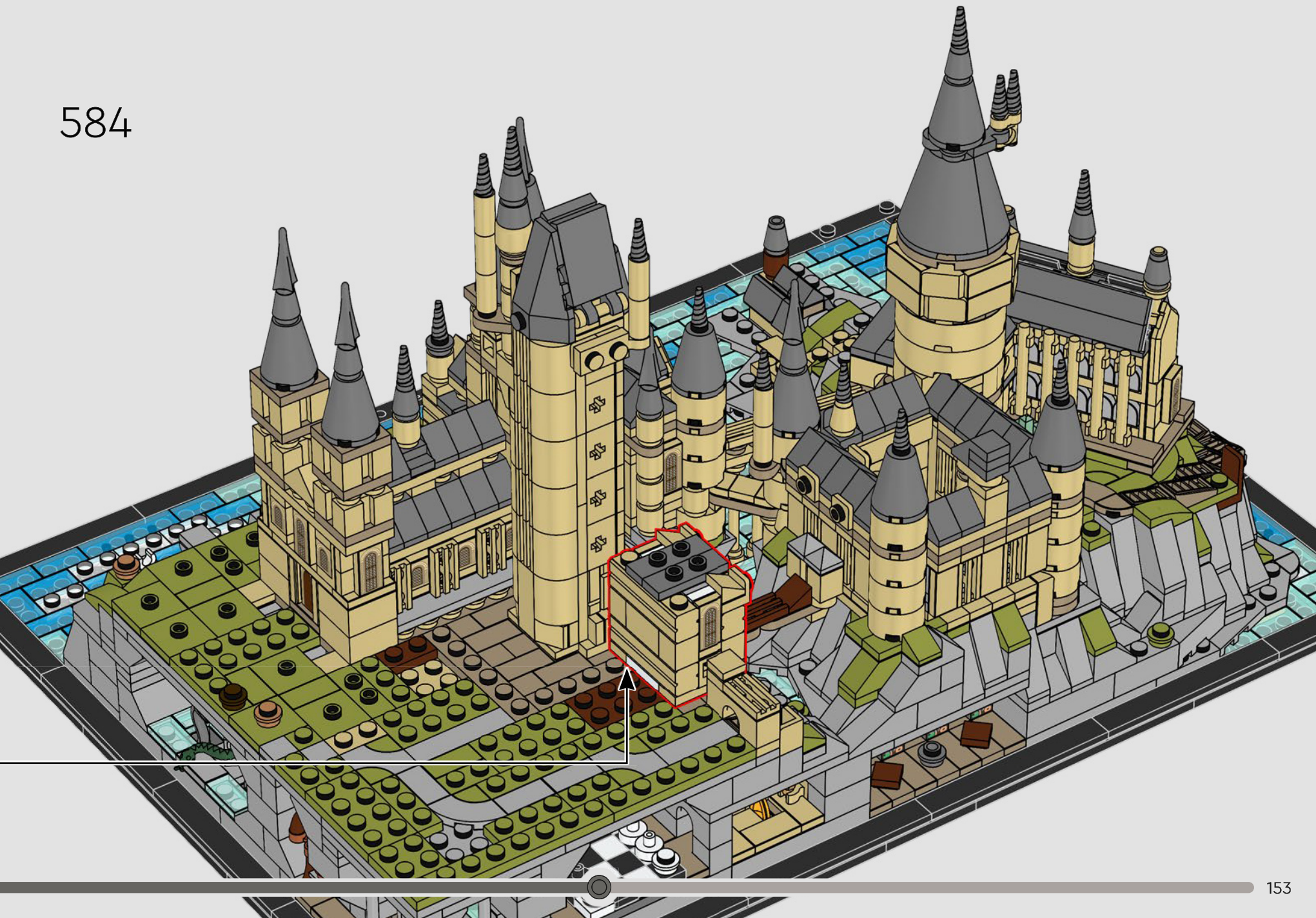

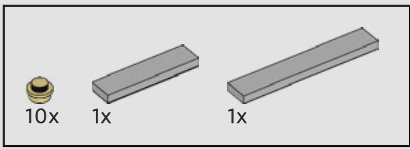

585

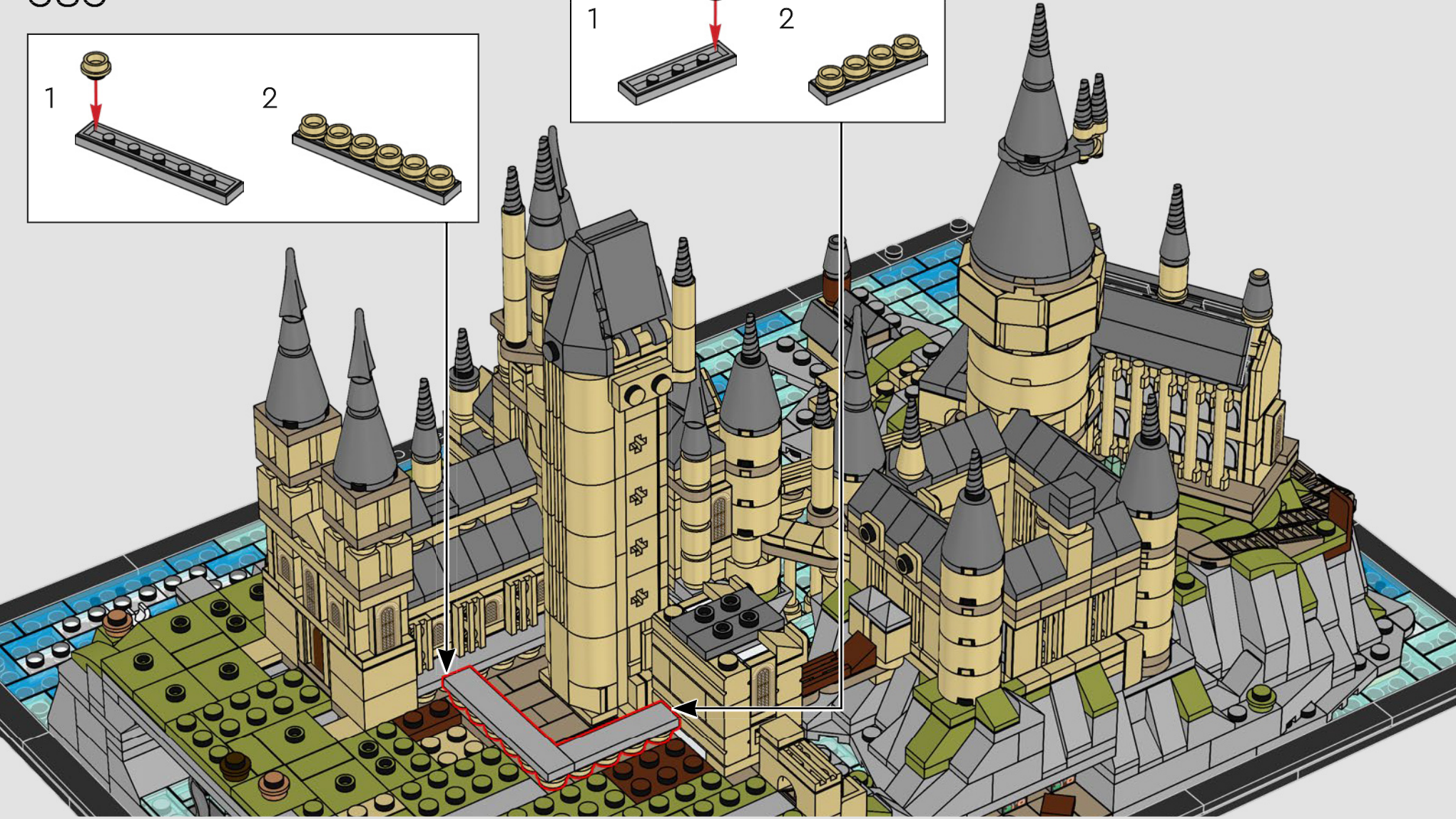
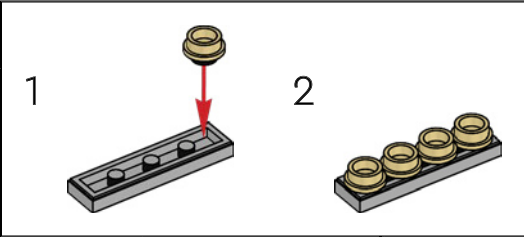
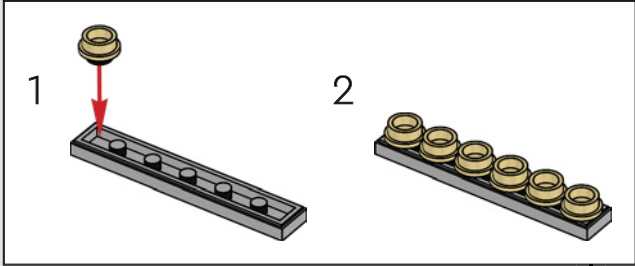

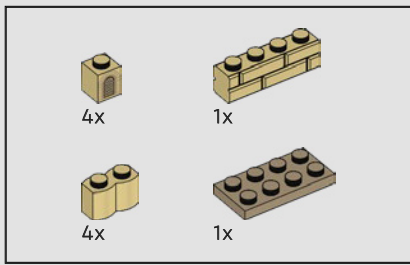

586

1

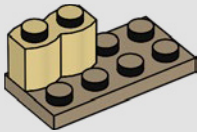

2

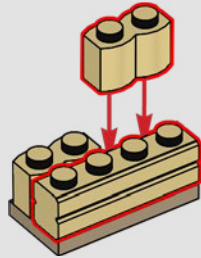

3

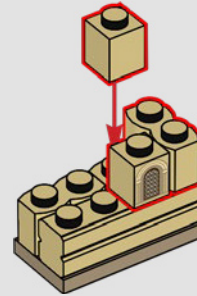

4

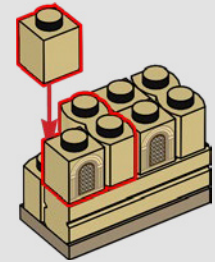





587



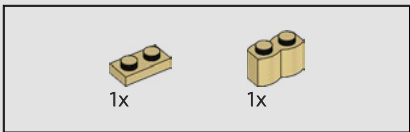

588

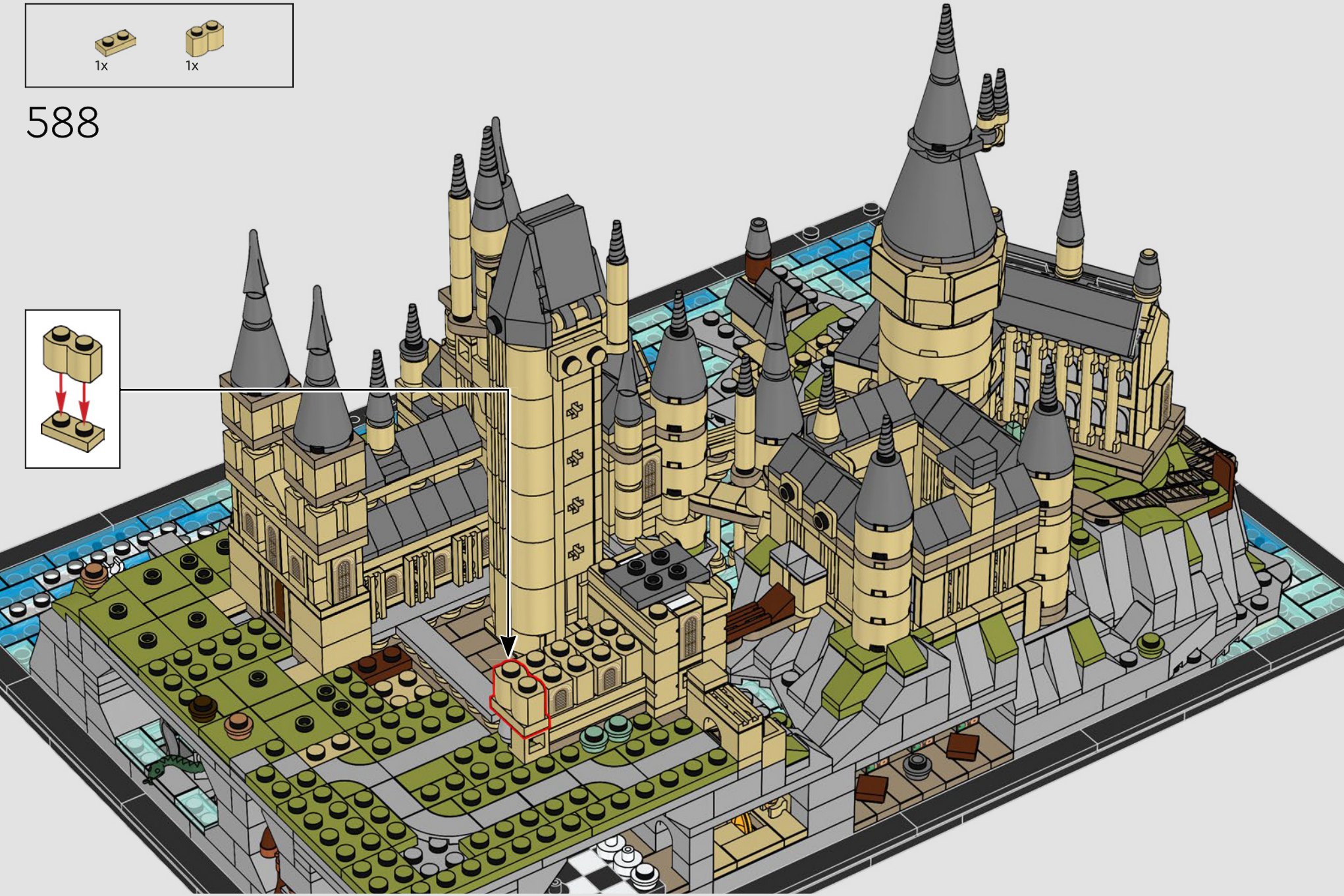
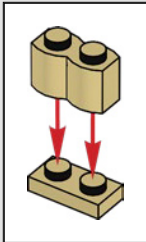

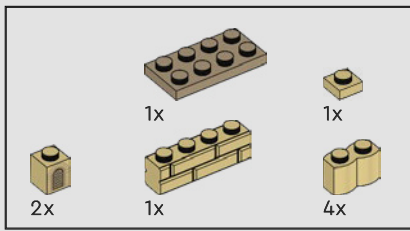

589

1

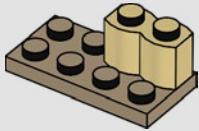

2

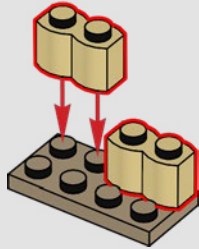

3

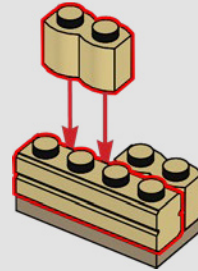

4

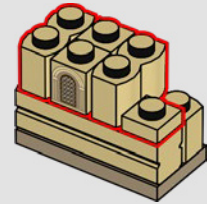

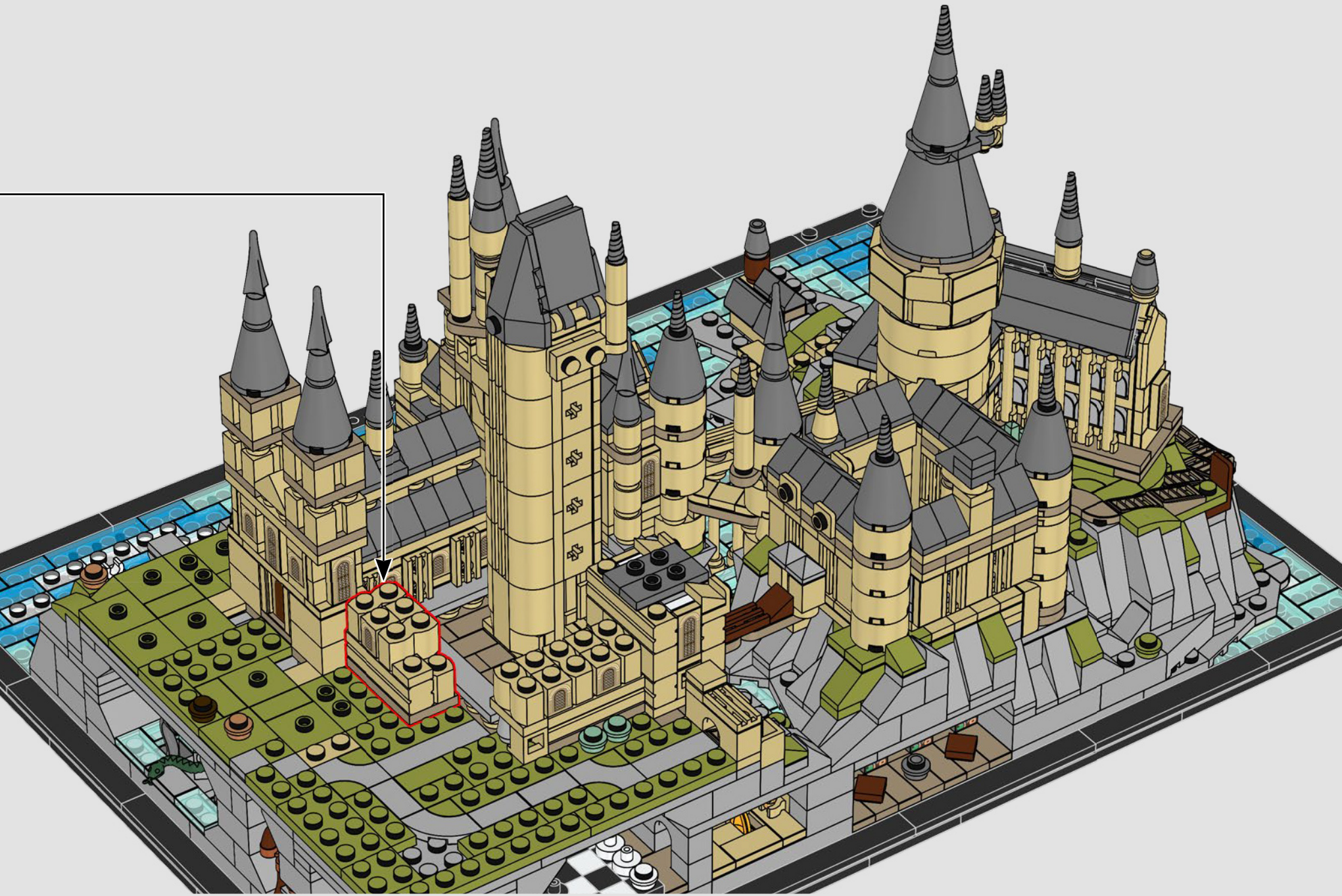

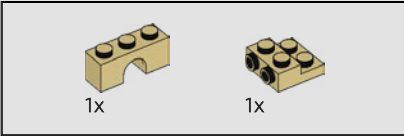
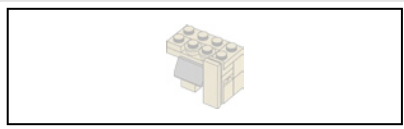

590

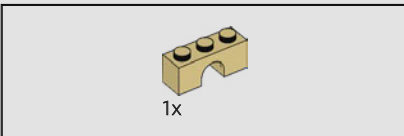
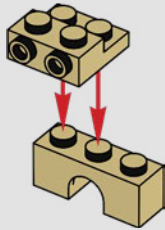

591

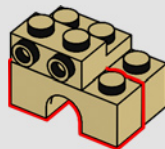

592

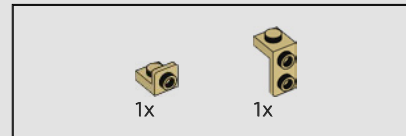
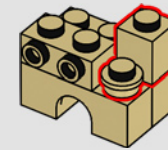

593

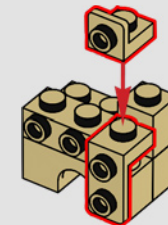

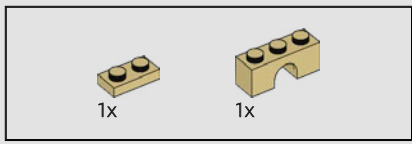

594

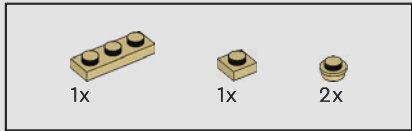
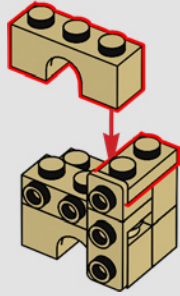

595

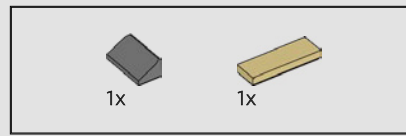
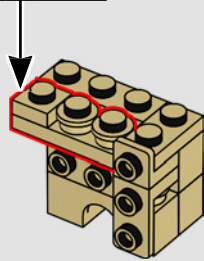
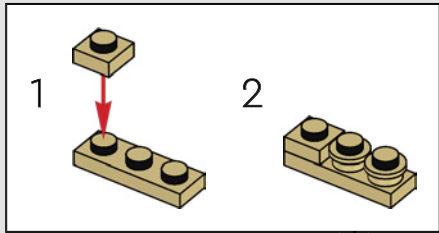

596

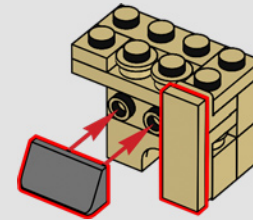

597



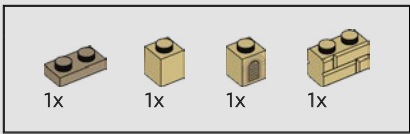

598

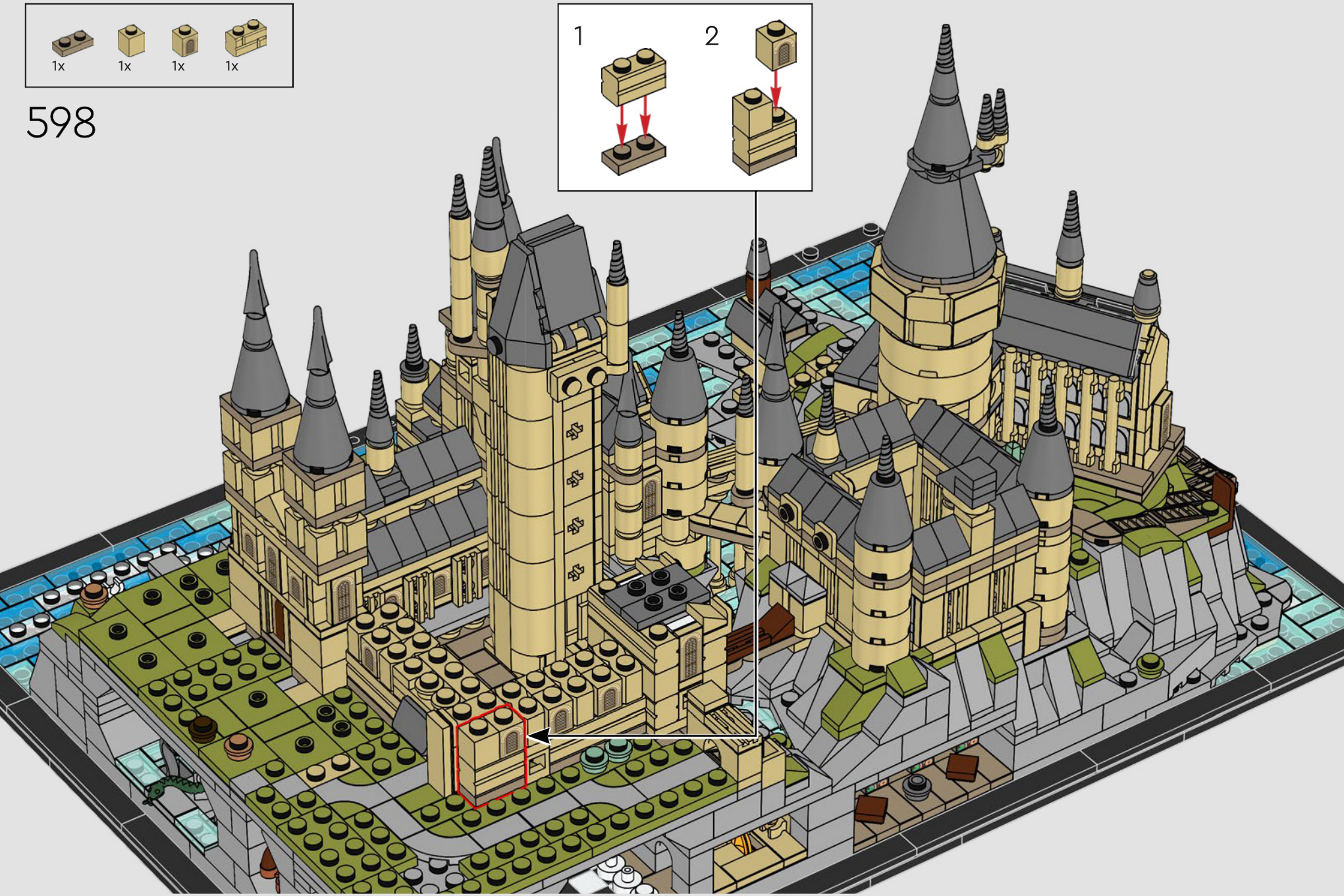
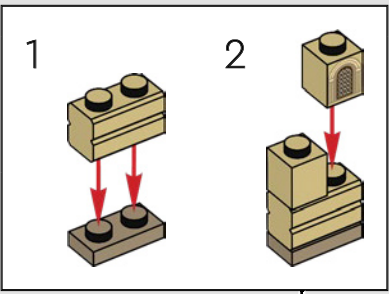

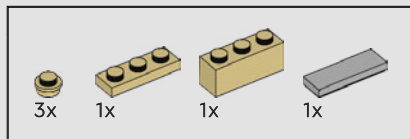

599

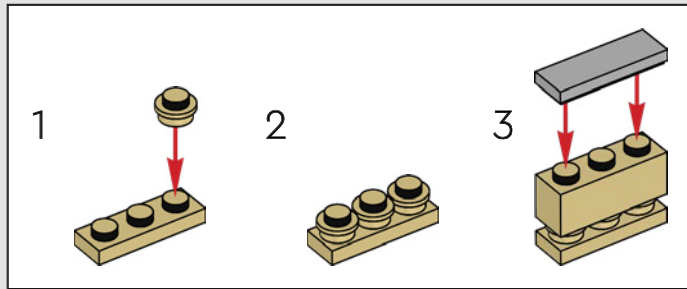

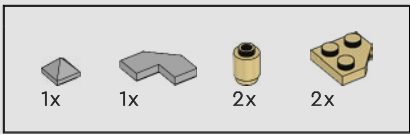

600

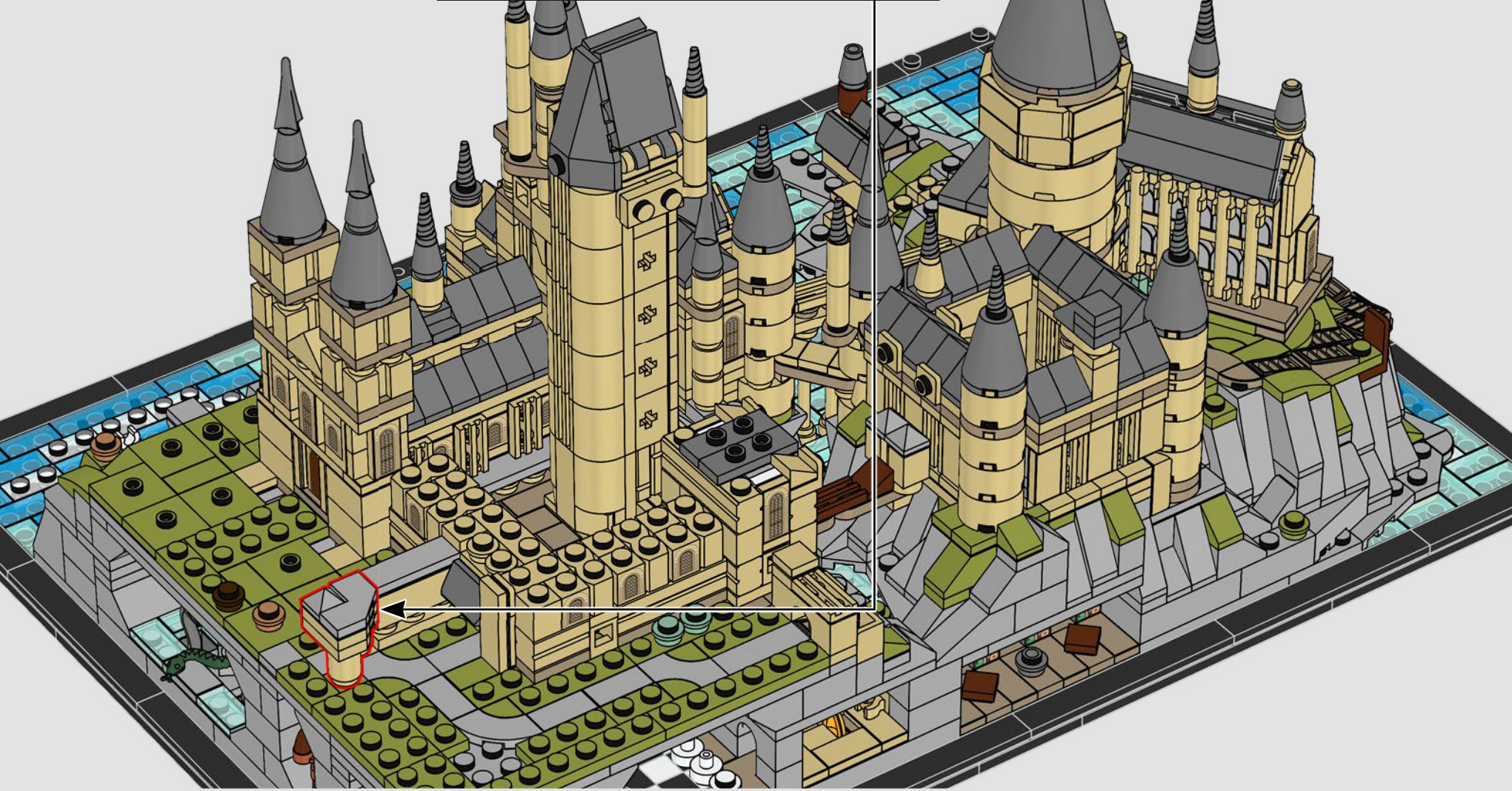
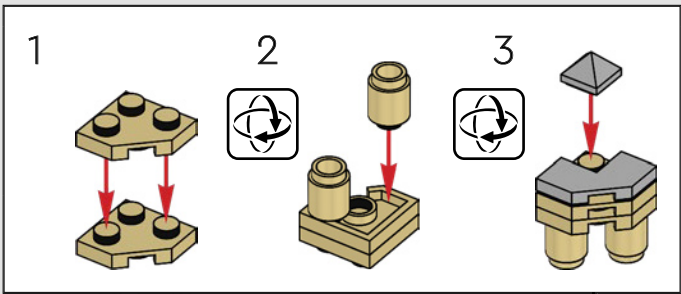

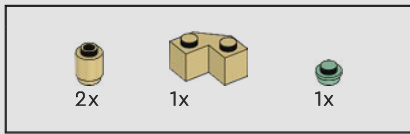

601

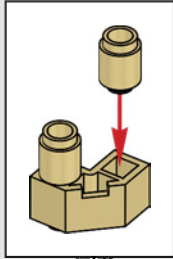



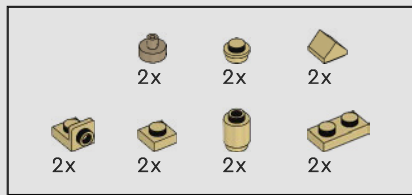

602

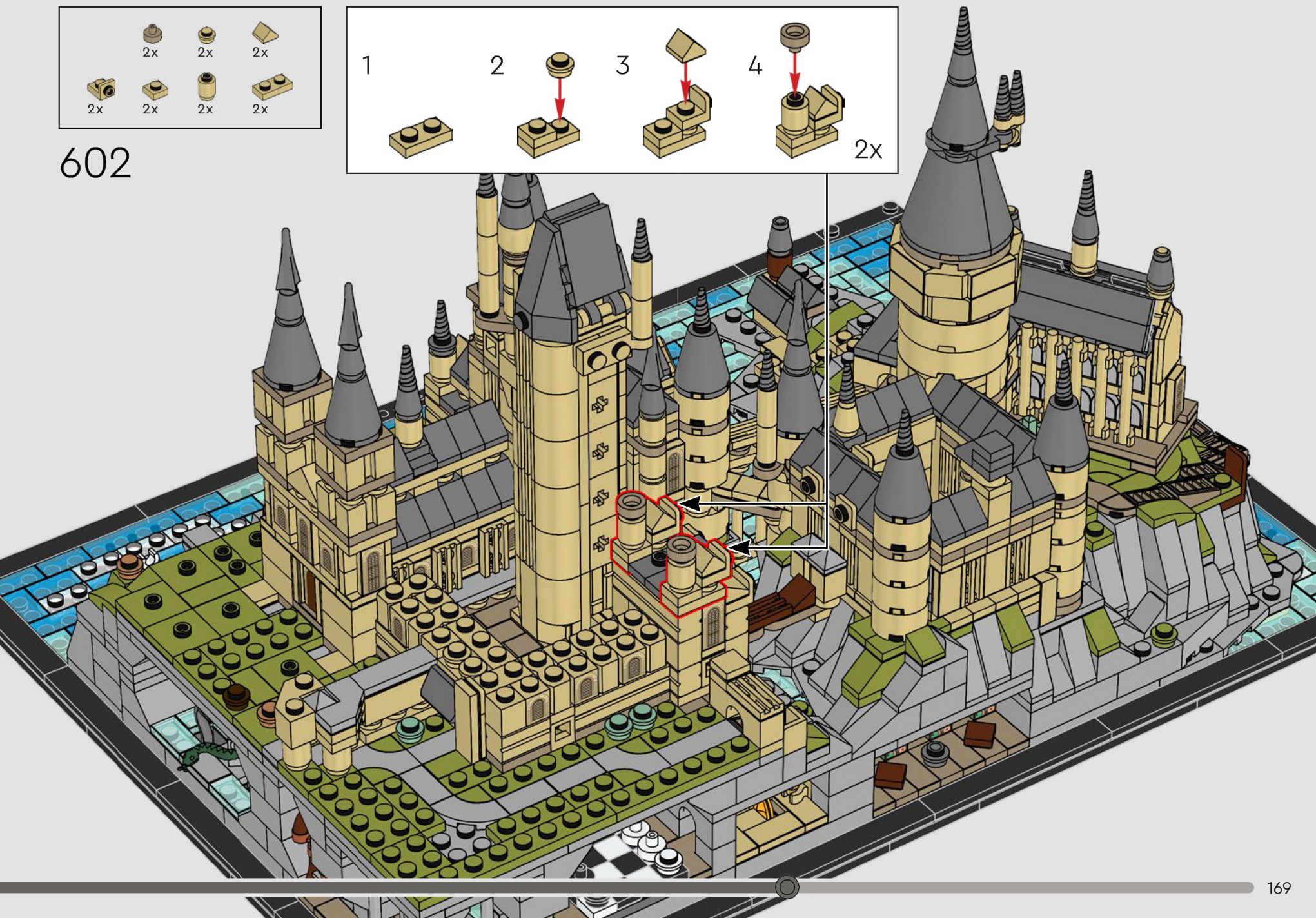
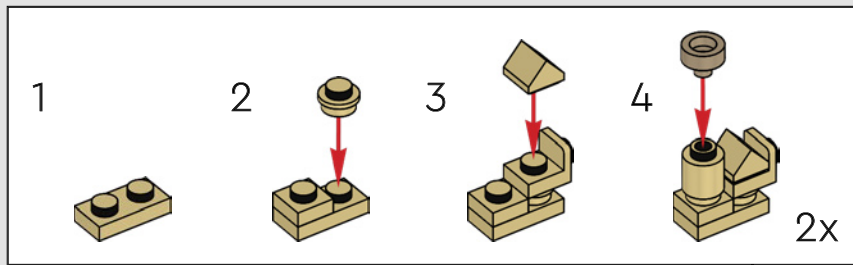

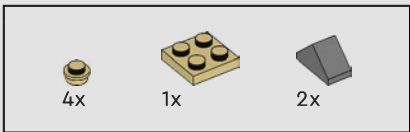

603

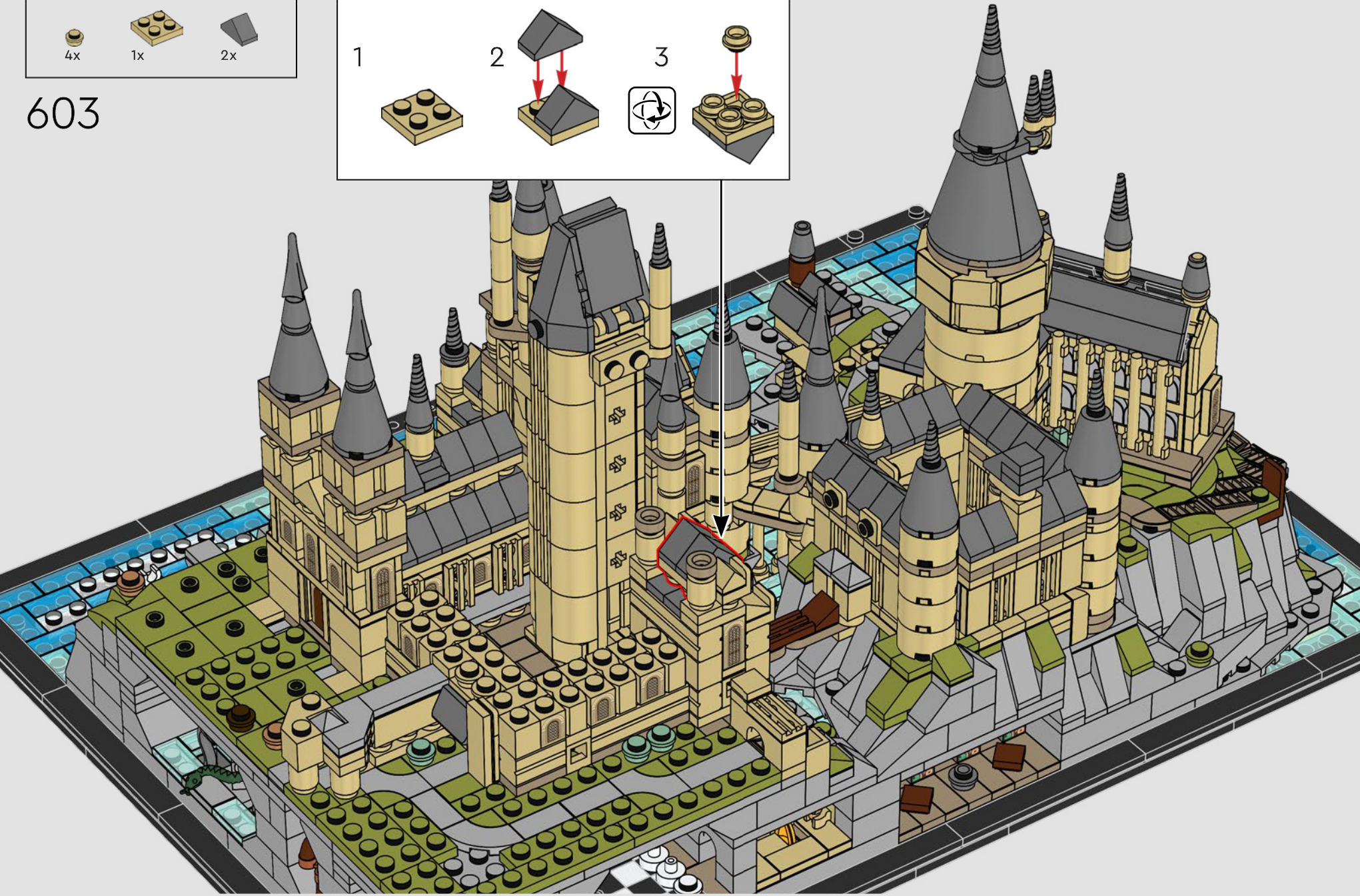
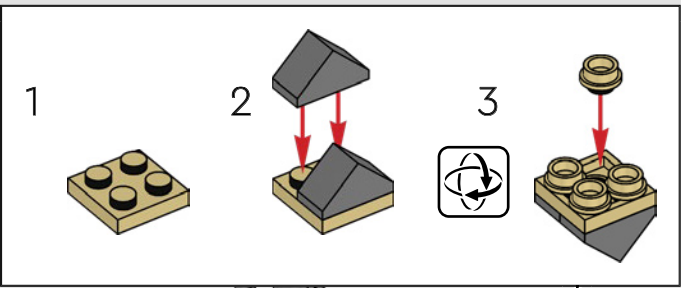

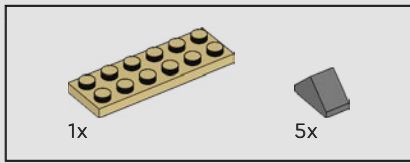

604

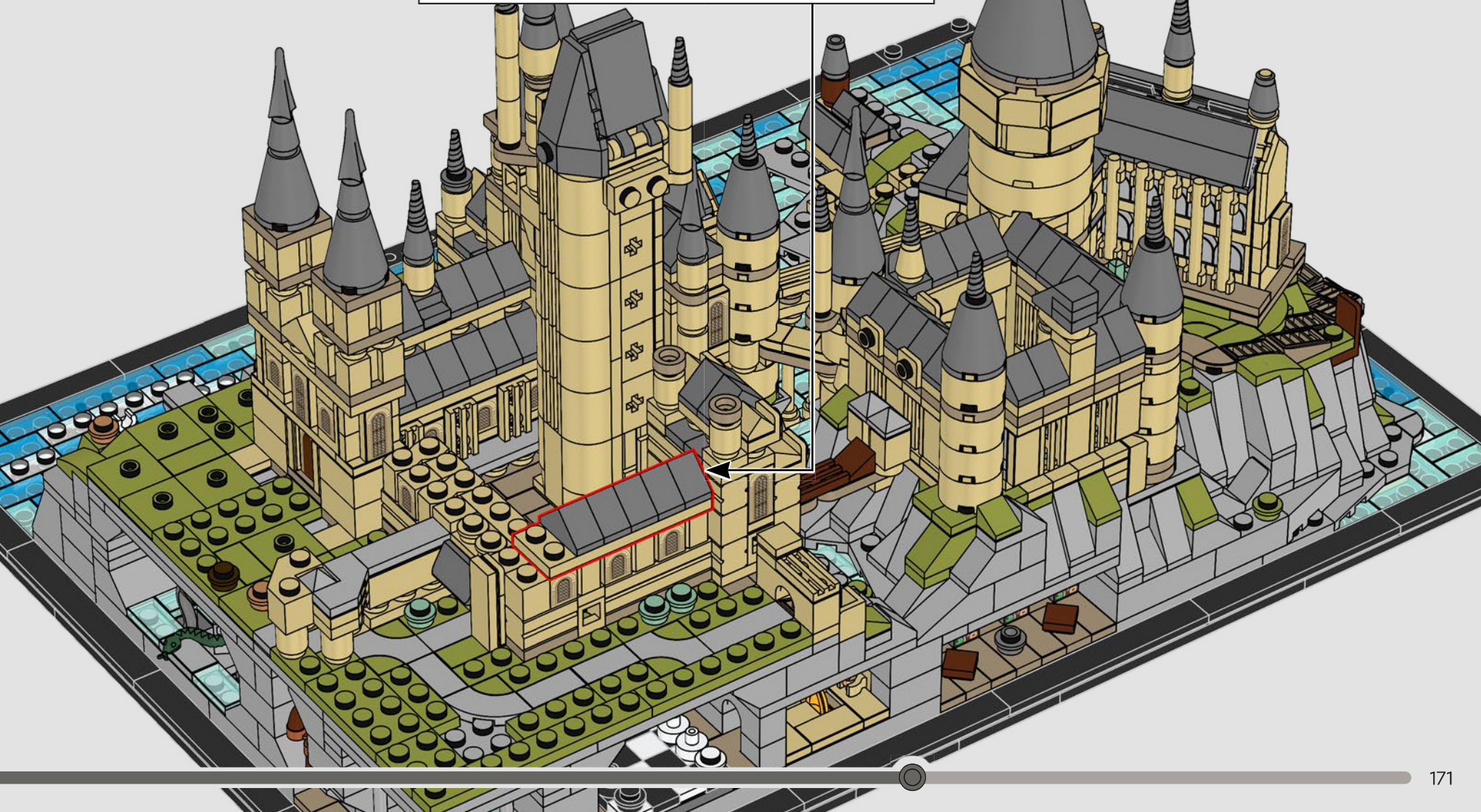
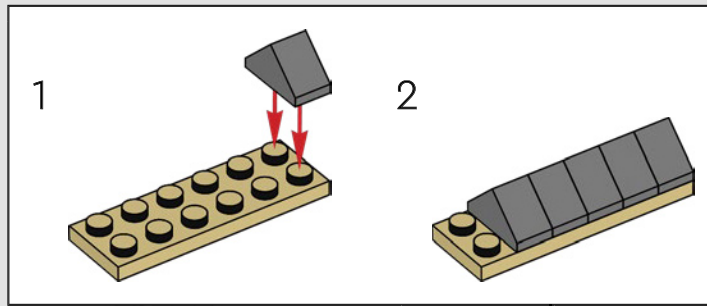

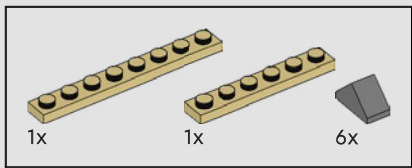

605

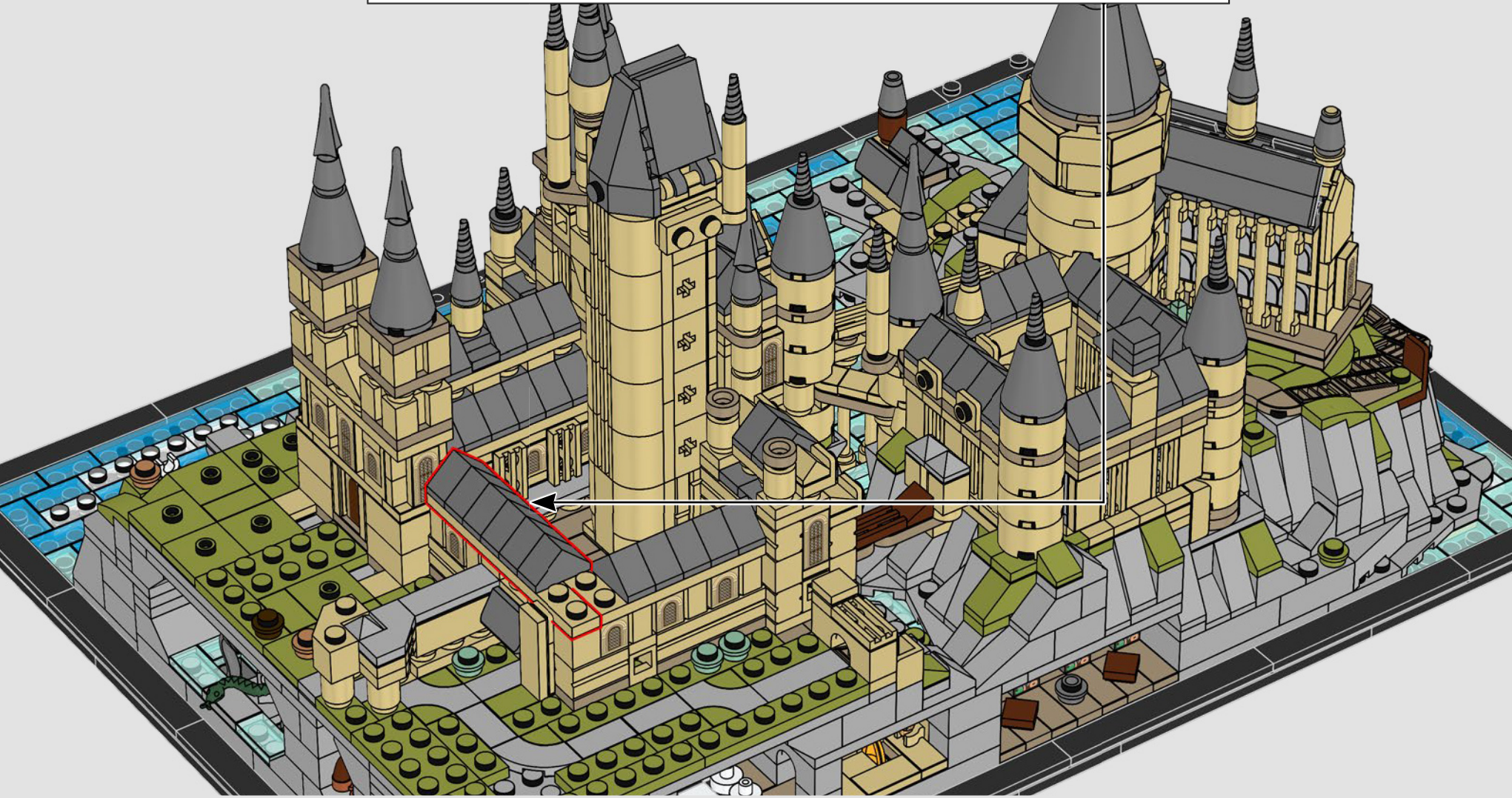
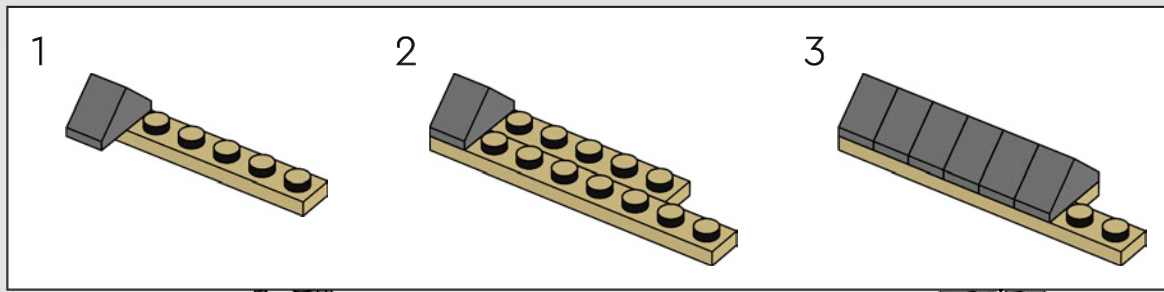

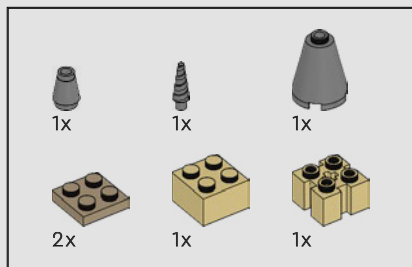

606

1

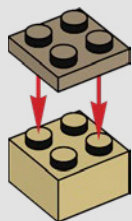

2

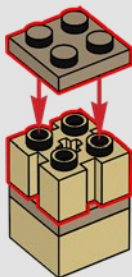

3

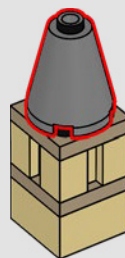

4

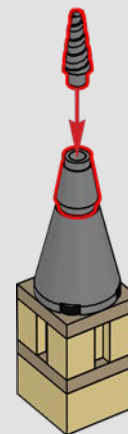



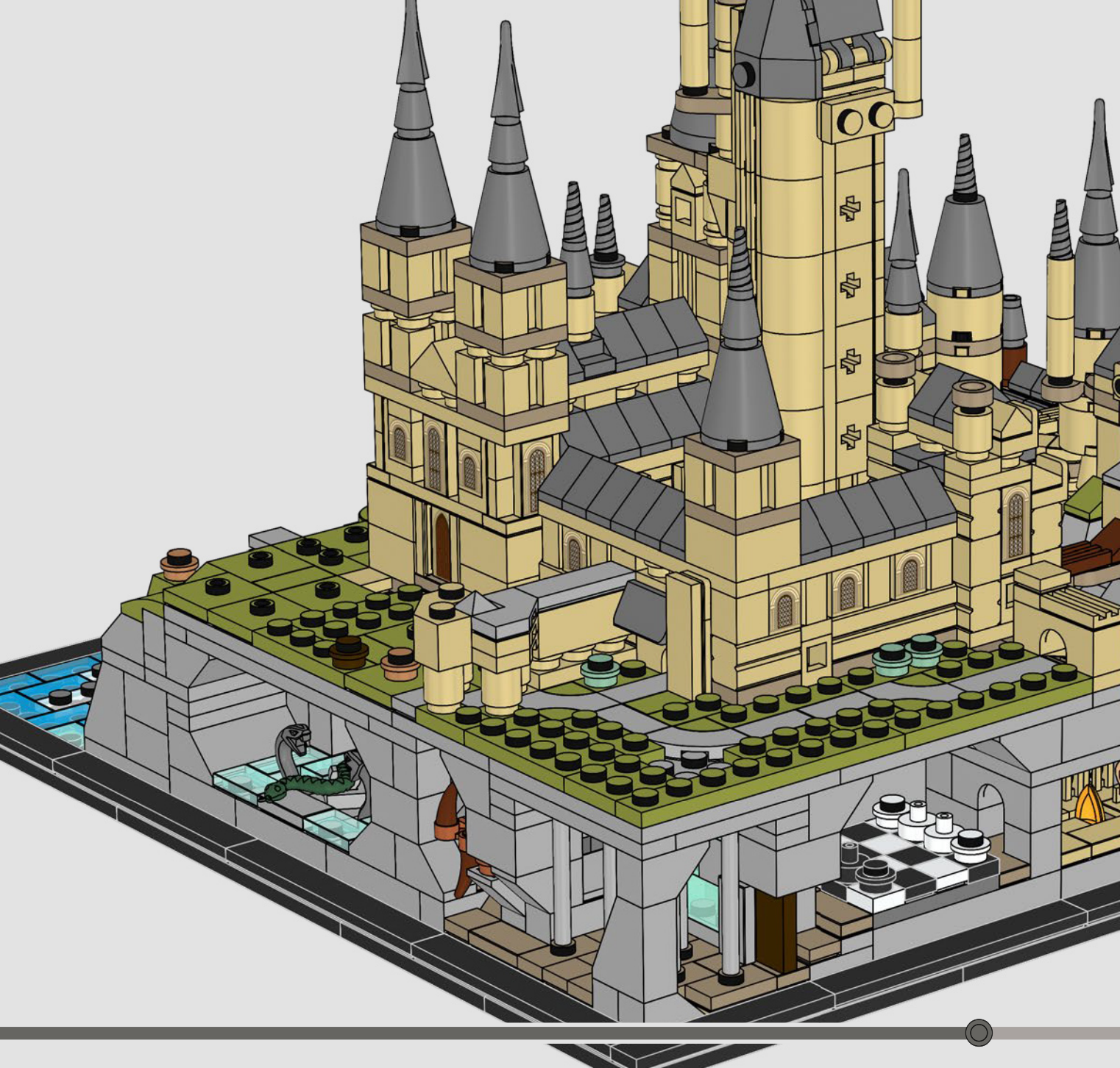

Poudlard est un château immense, où il est facile de se perdre. Mais saviez-vous qu'il comptait 142 escaliers ? Comme ils changent constamment de place, il est encore plus difficile de retrouver son chemin.

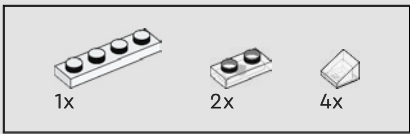

607

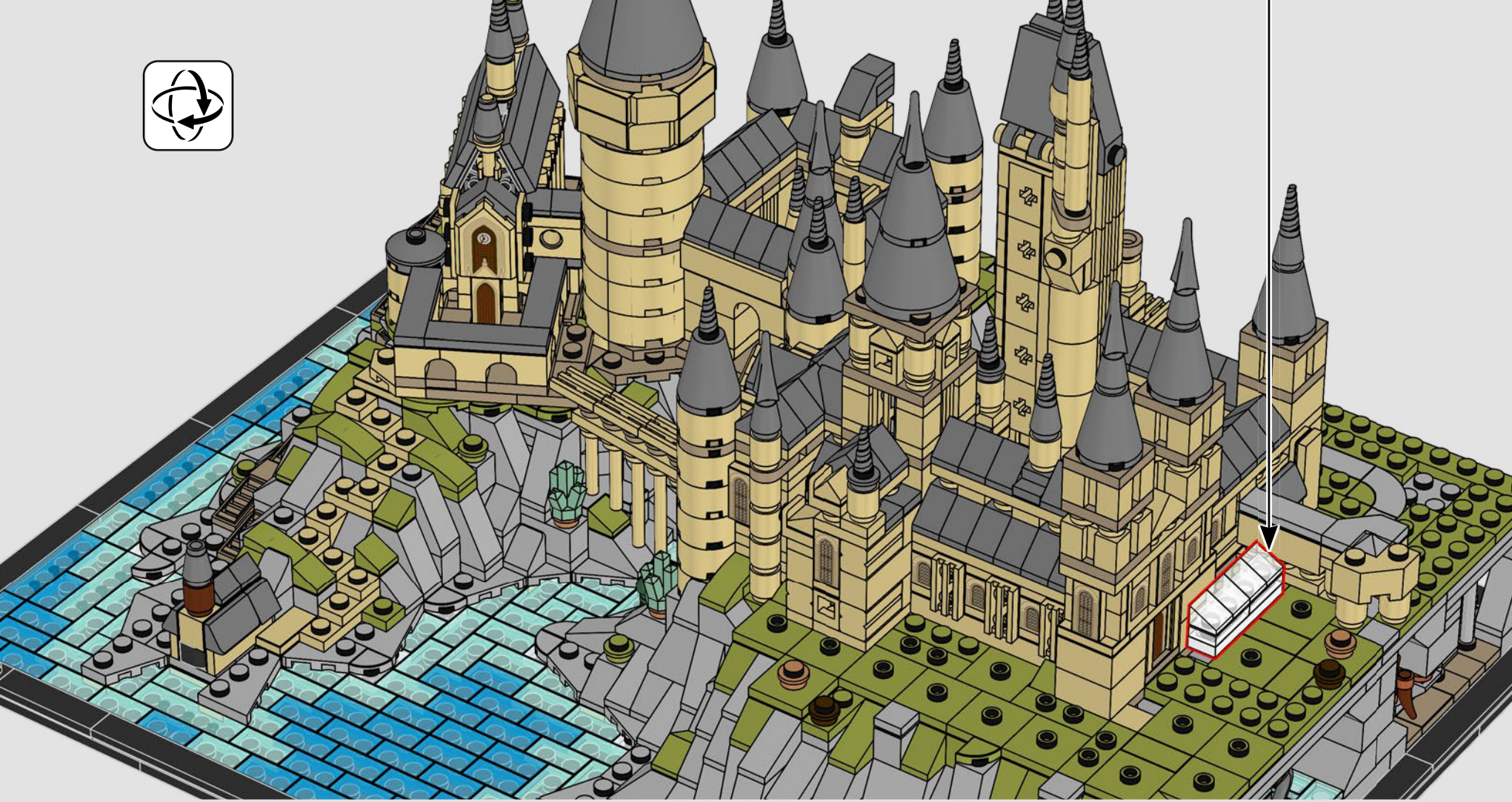
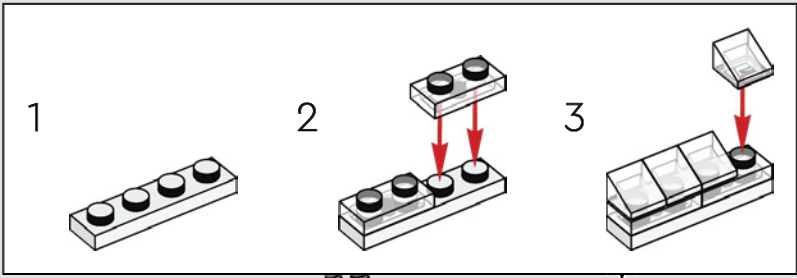

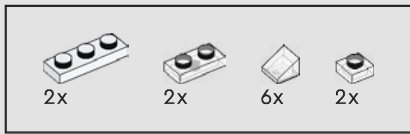

608

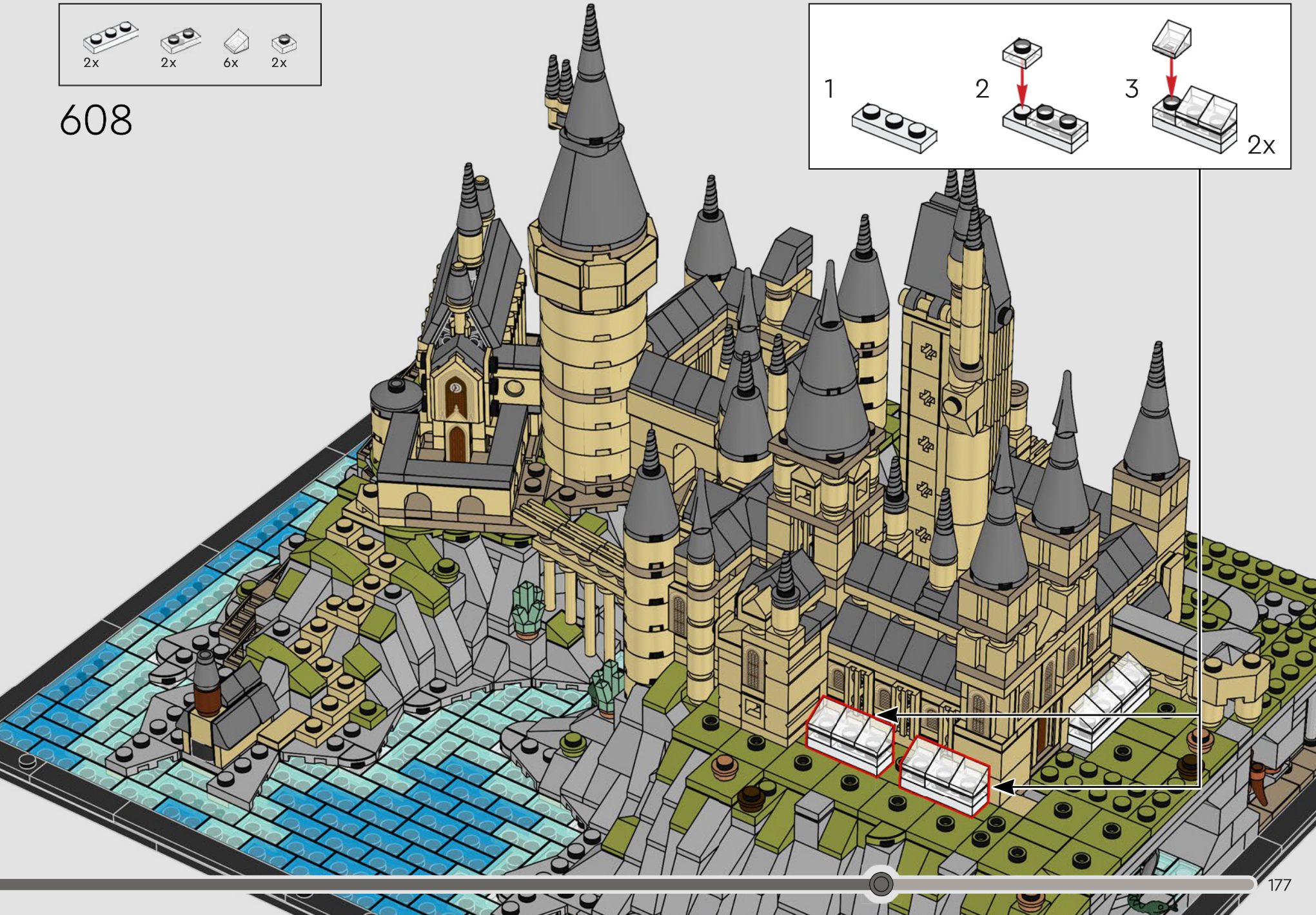
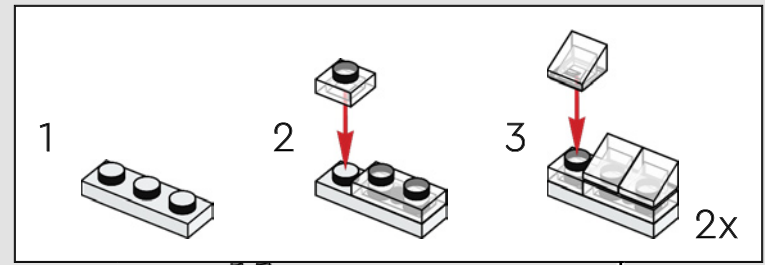



609

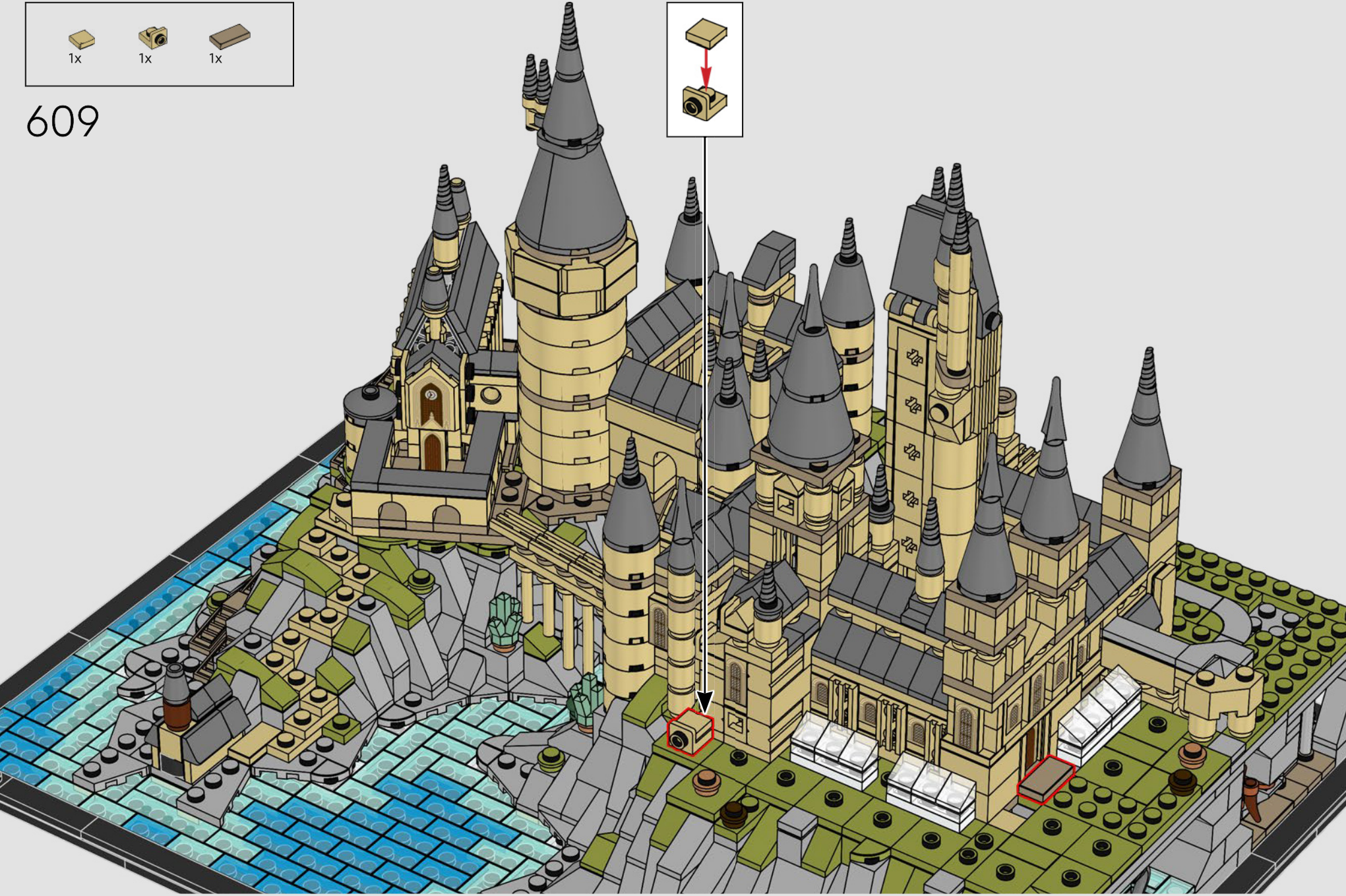
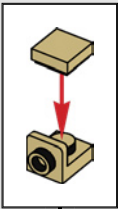



610

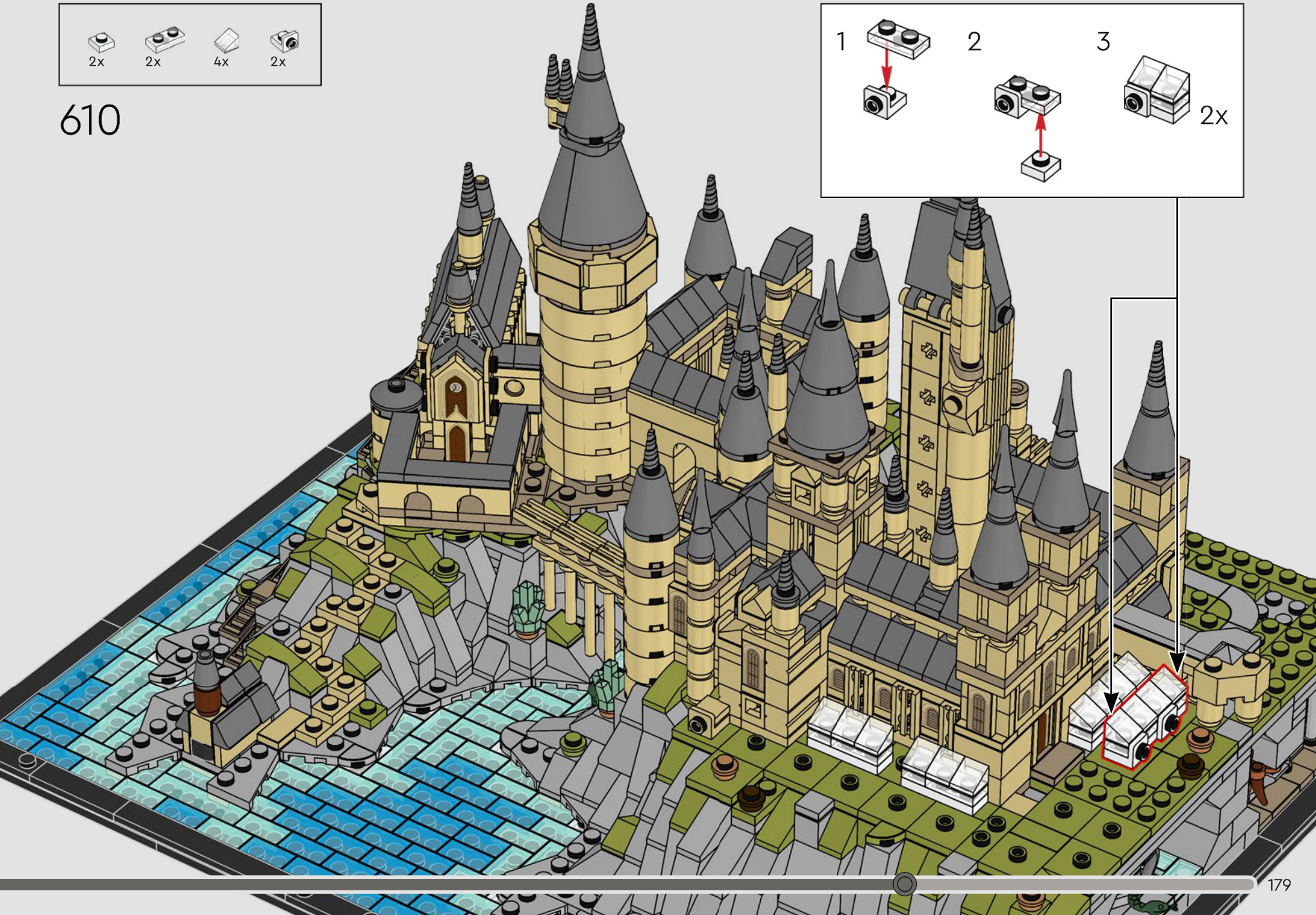
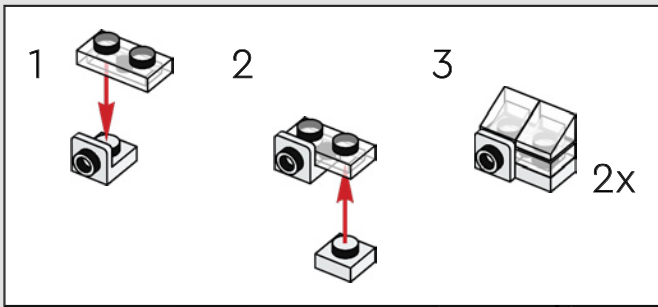

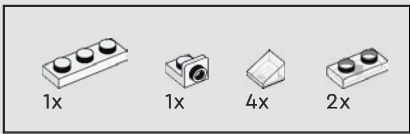

611

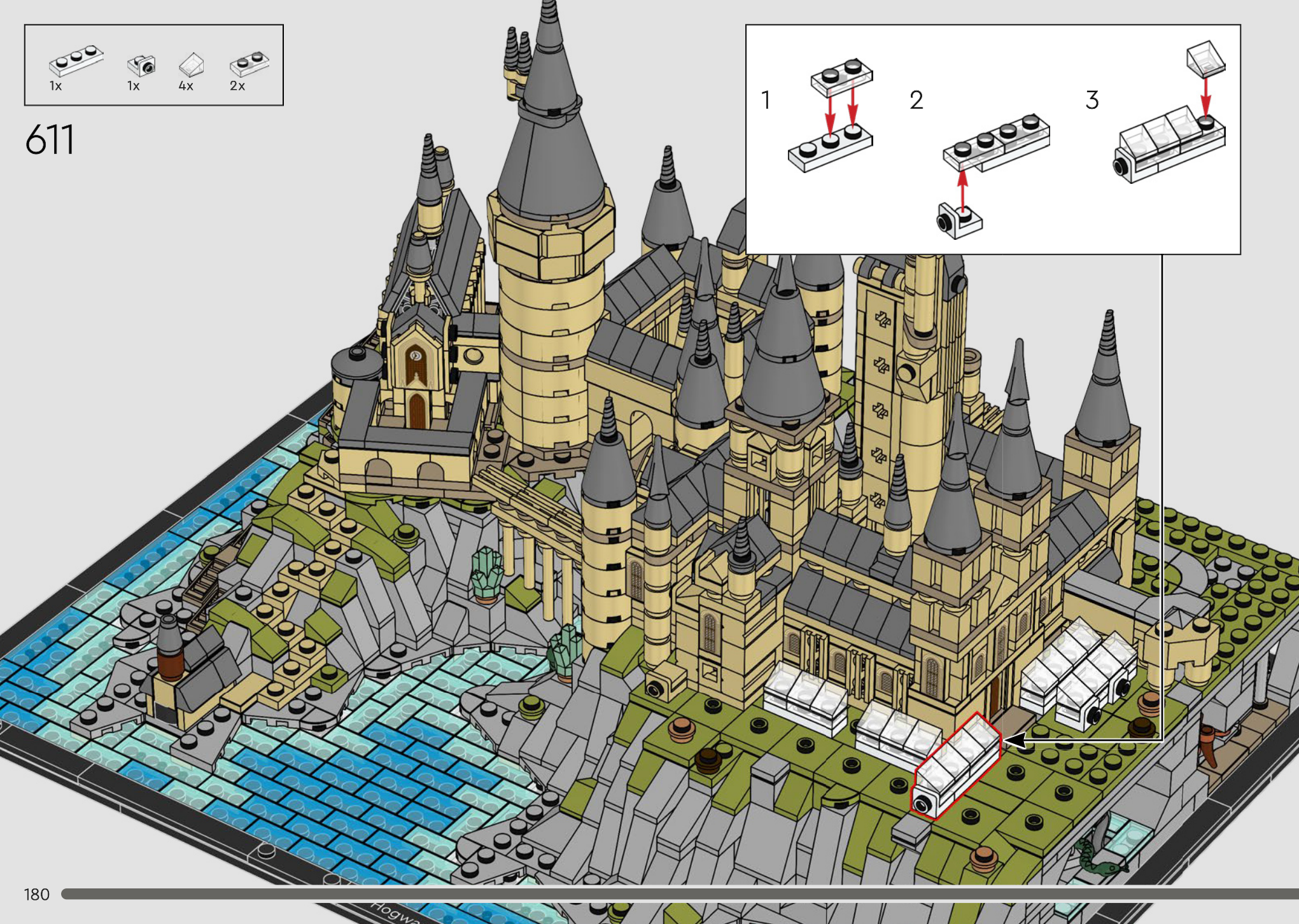
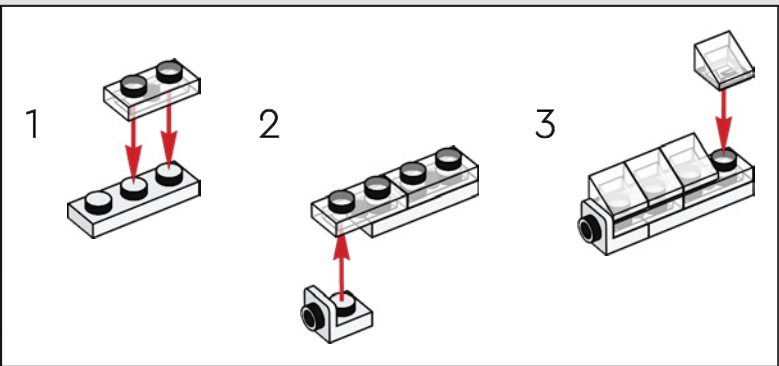

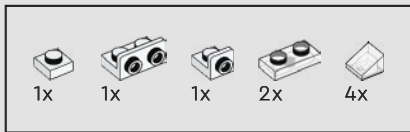

612

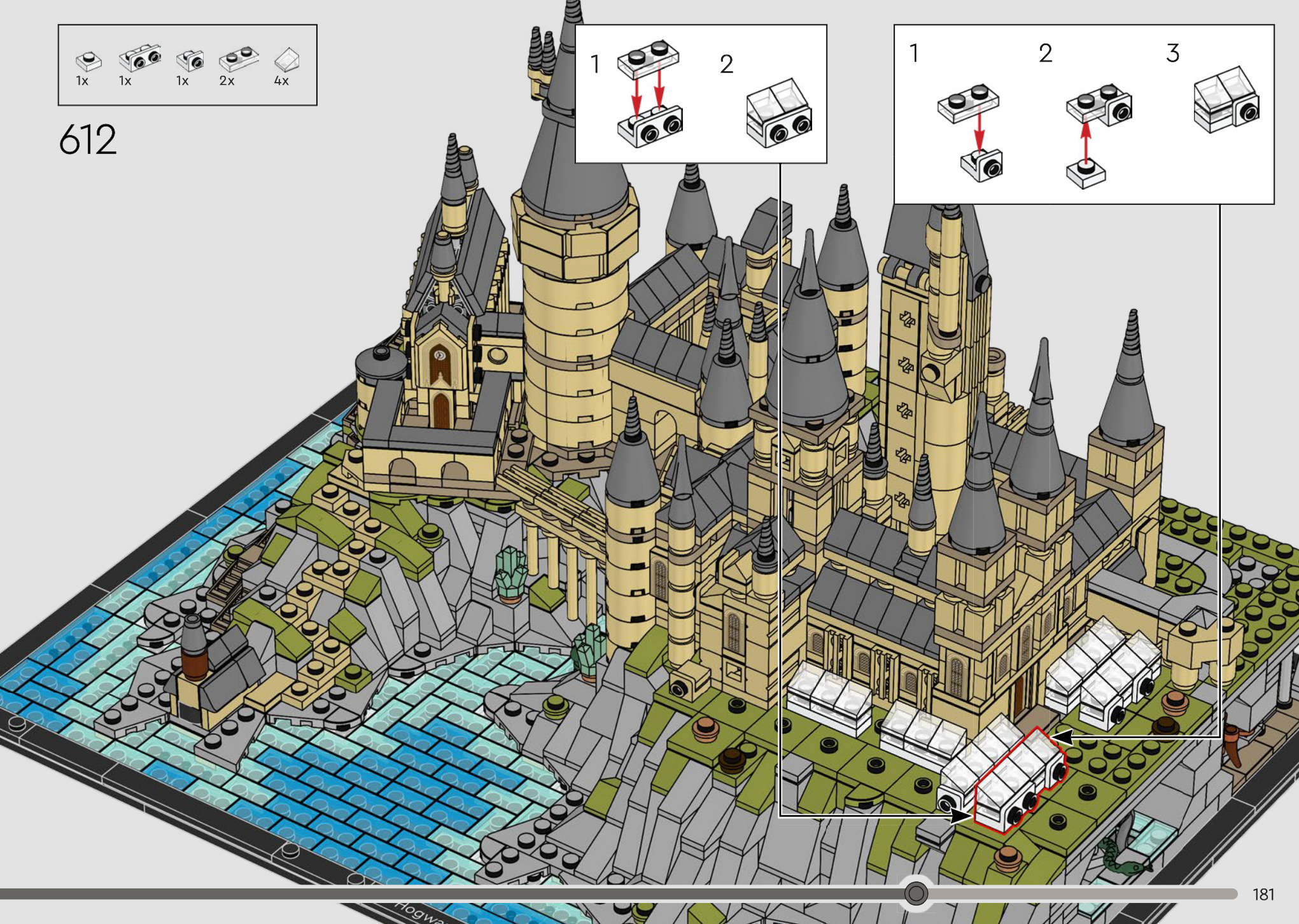
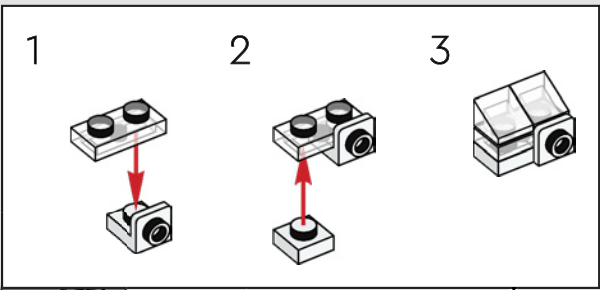
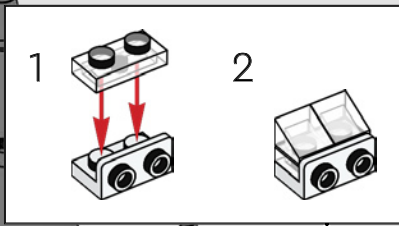

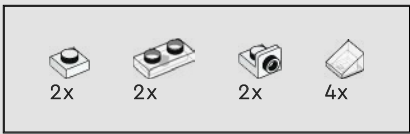

613

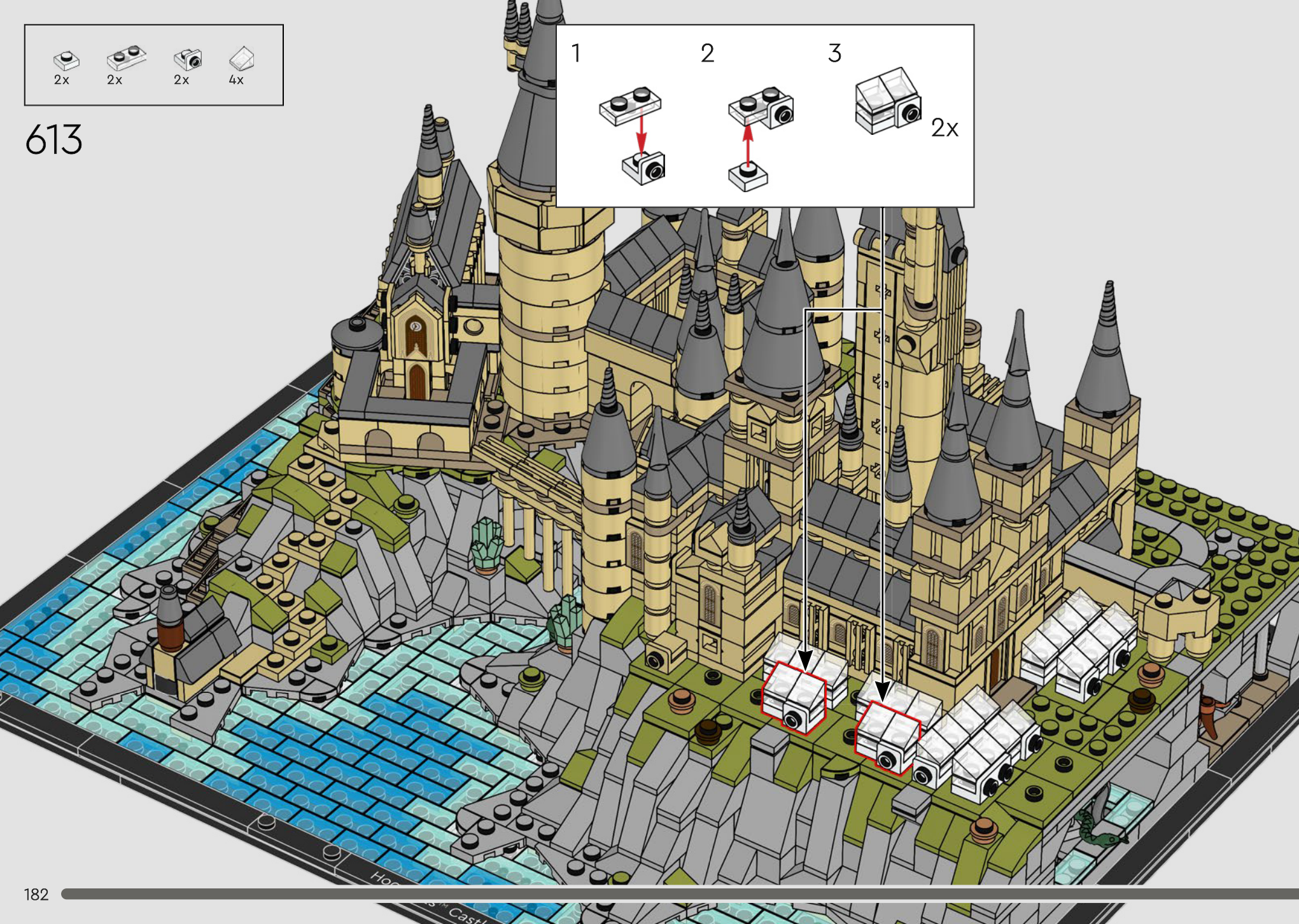
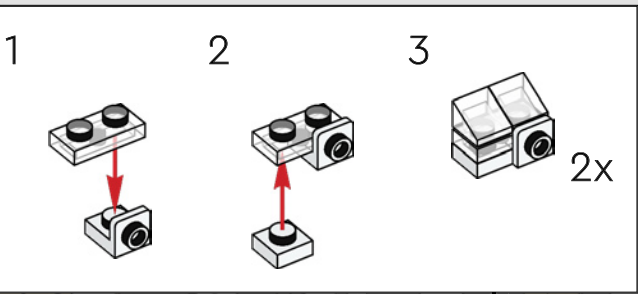



614

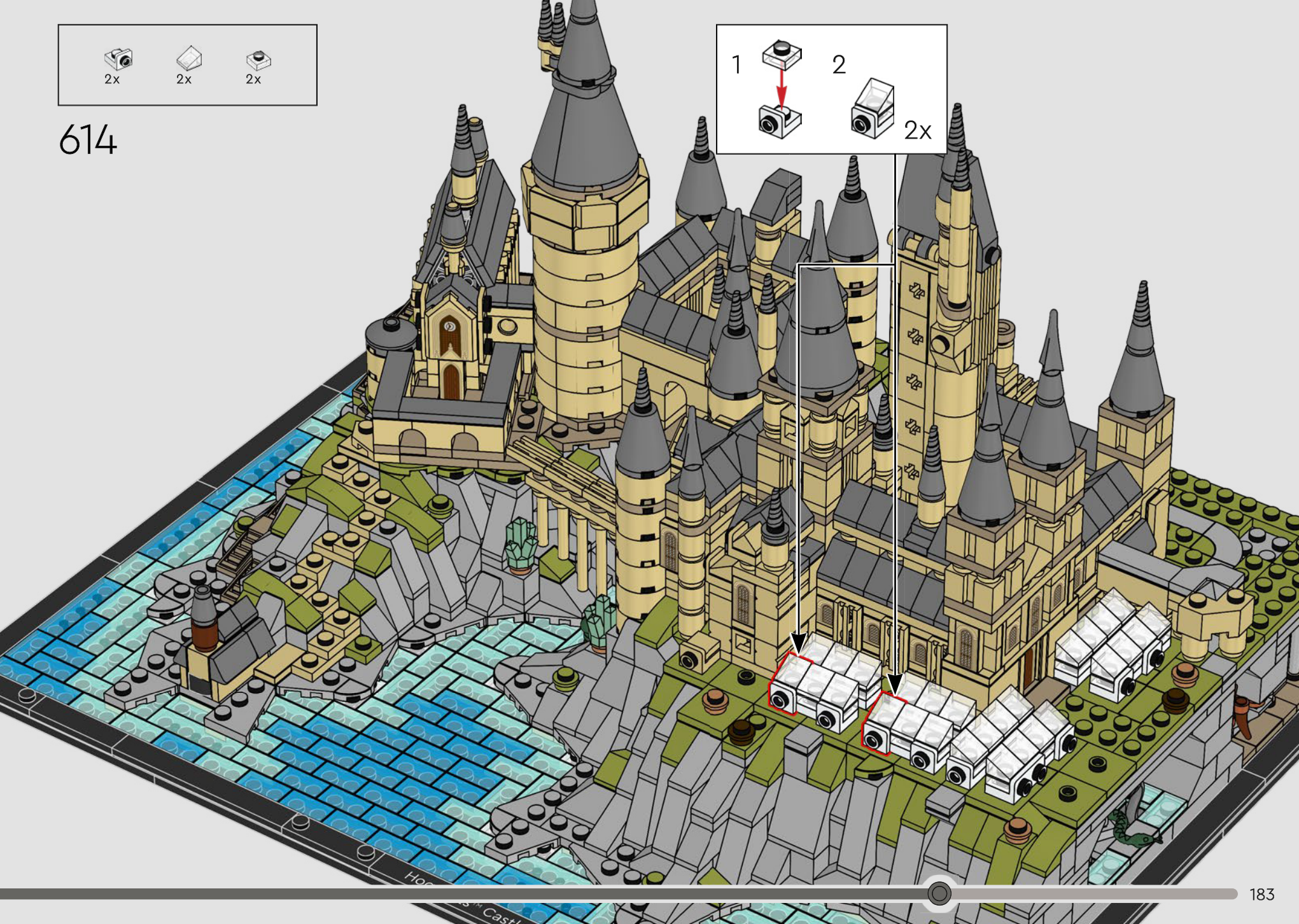
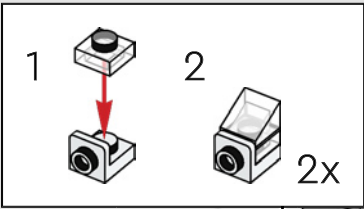

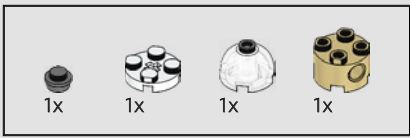

615

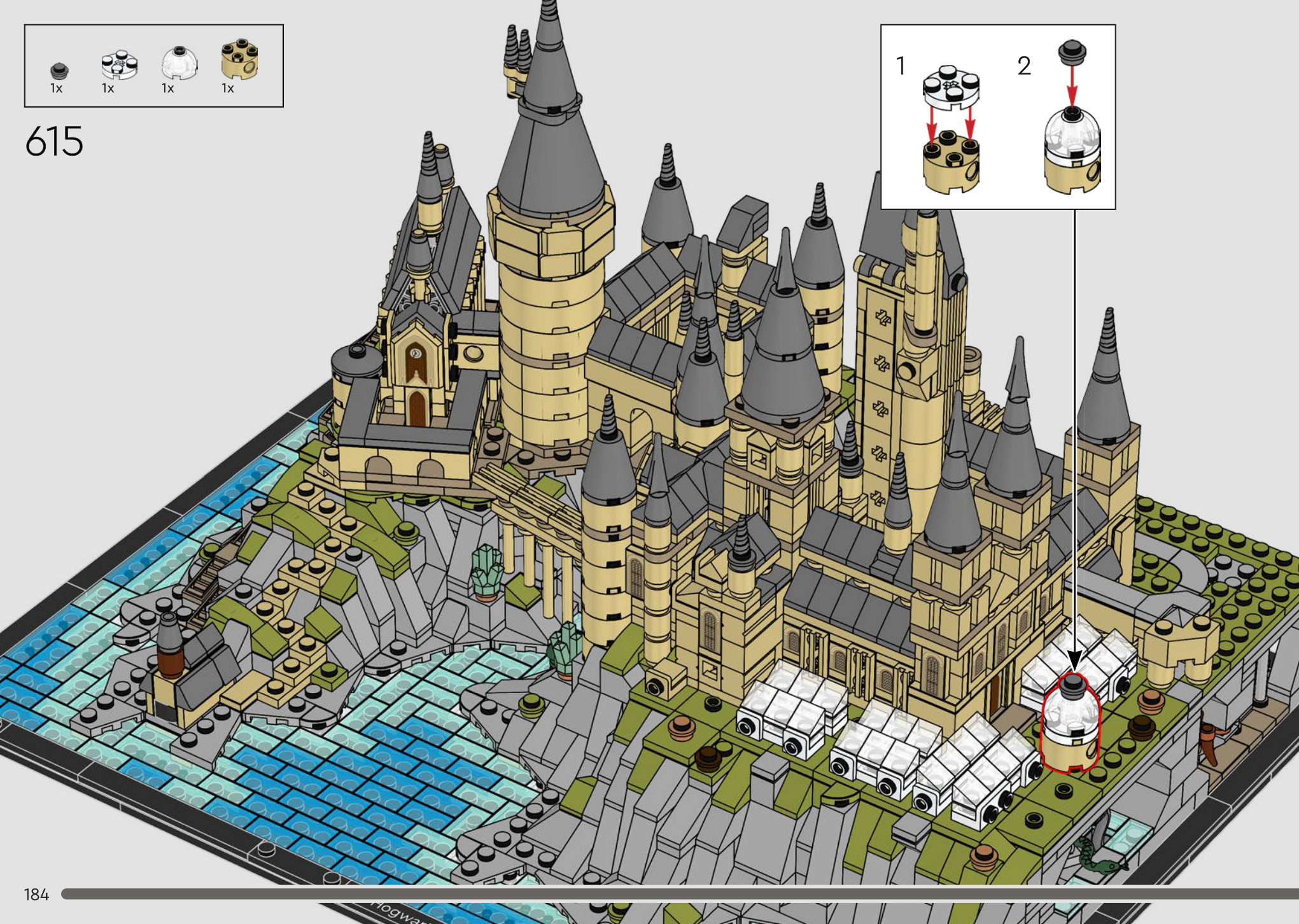
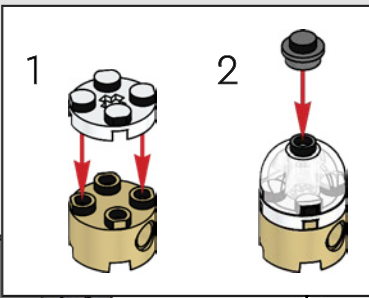

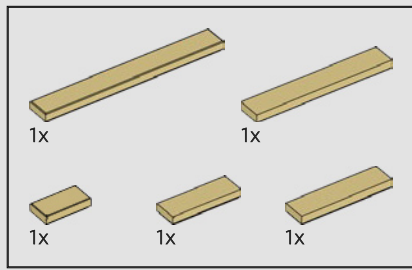

616

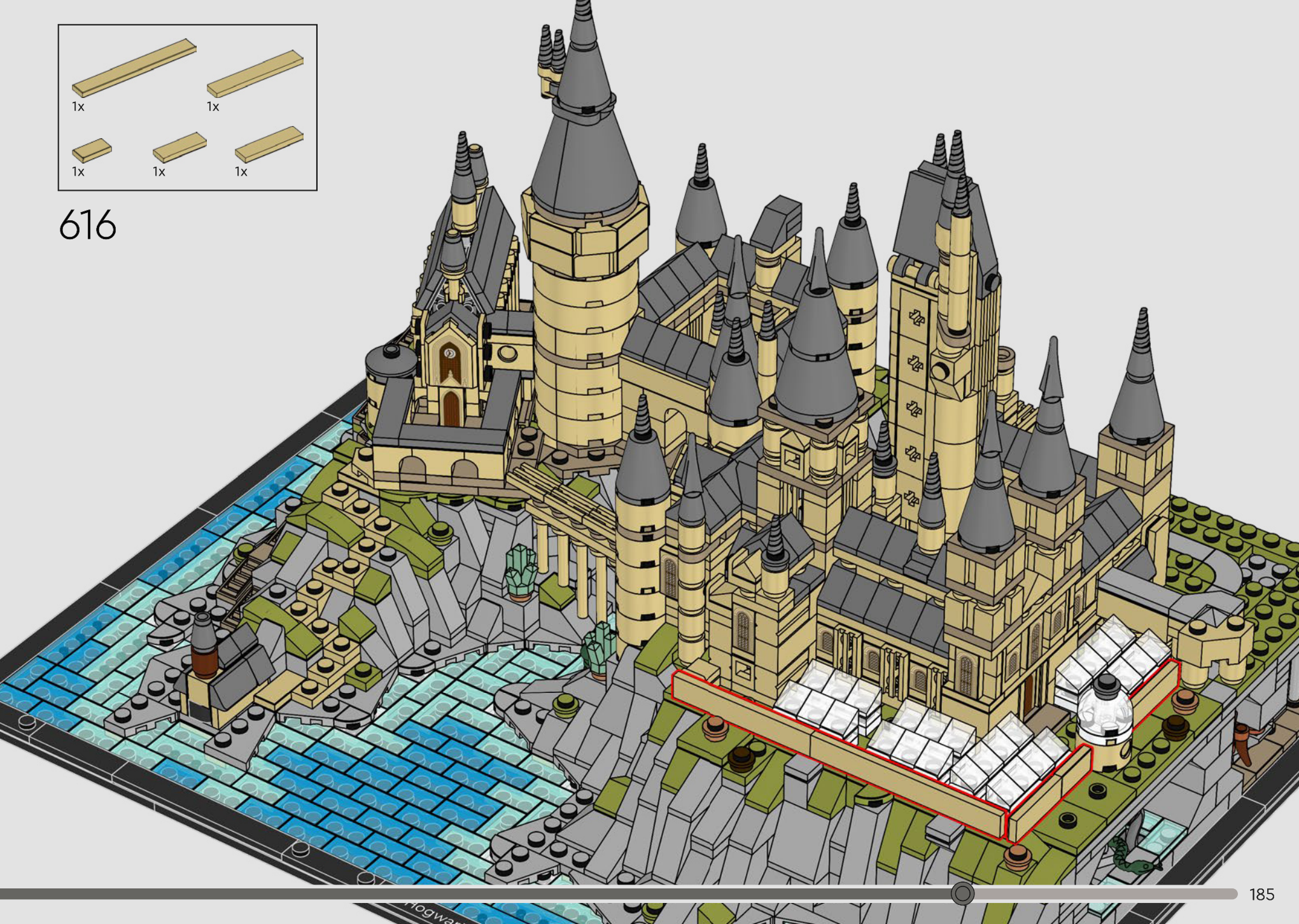

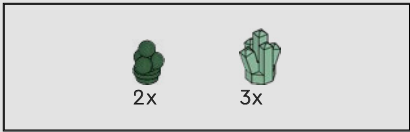

617

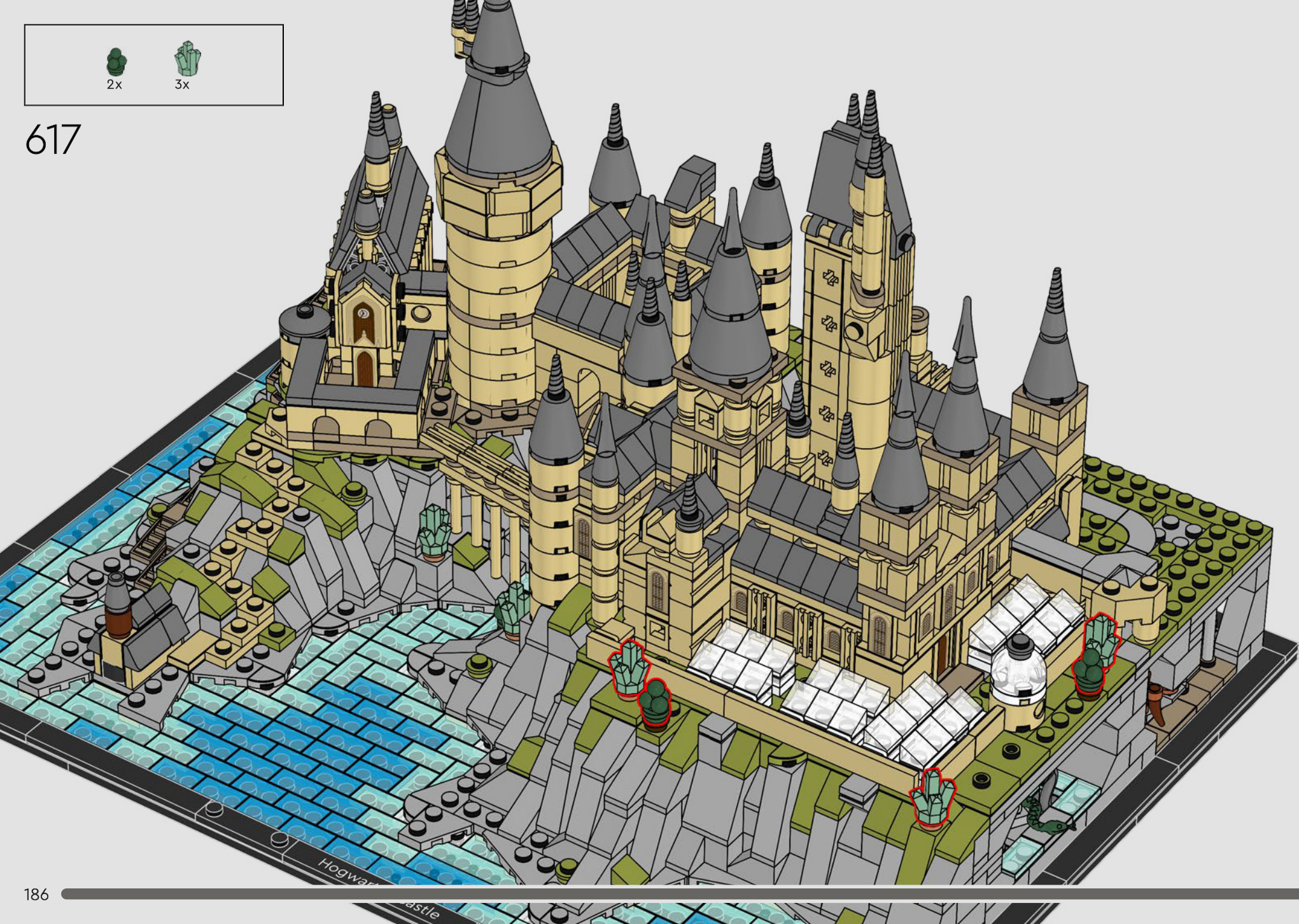

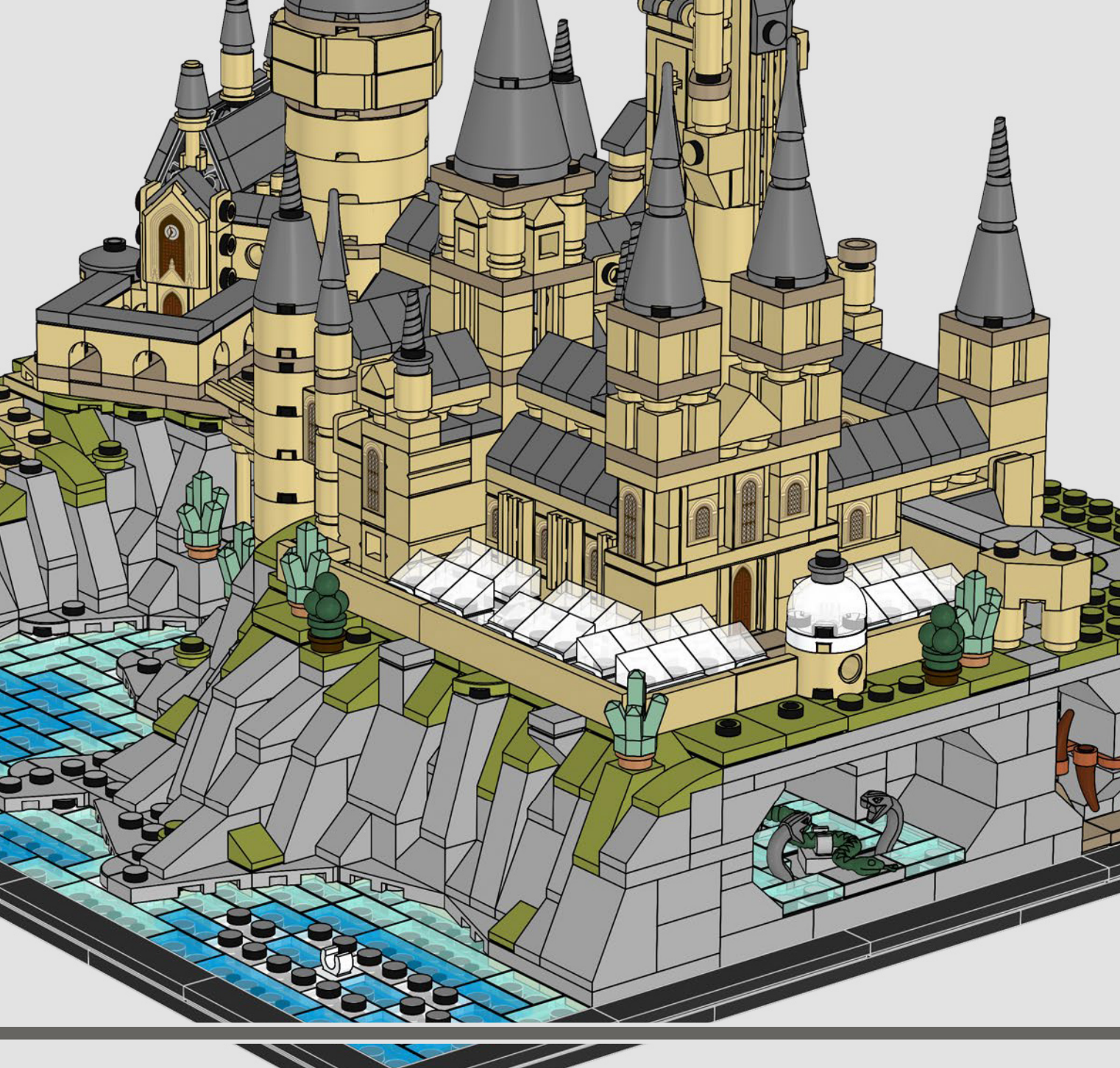

C'est dans les serres que le Professeur Chourave, responsable du département de botanique à Poudlard, apprend aux élèves à s'occuper des plantes magiques et à les utiliser en toute sécurité. Si seulement tout le monde utilisait ses protège-oreilles...



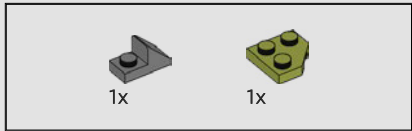

618

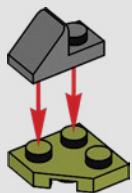

619

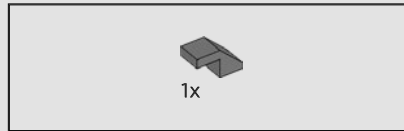
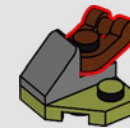

620

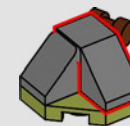

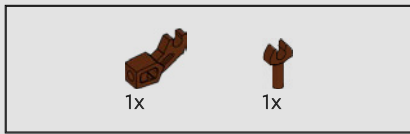

621

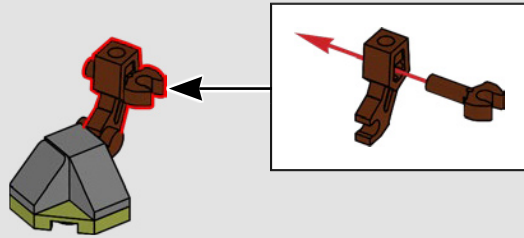

622



623

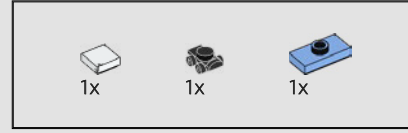
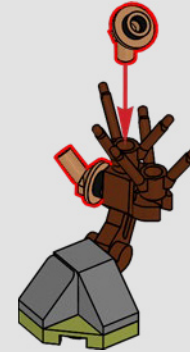

624

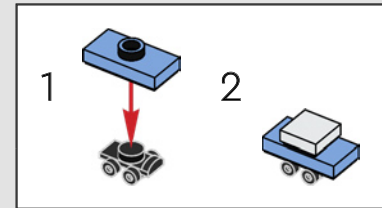



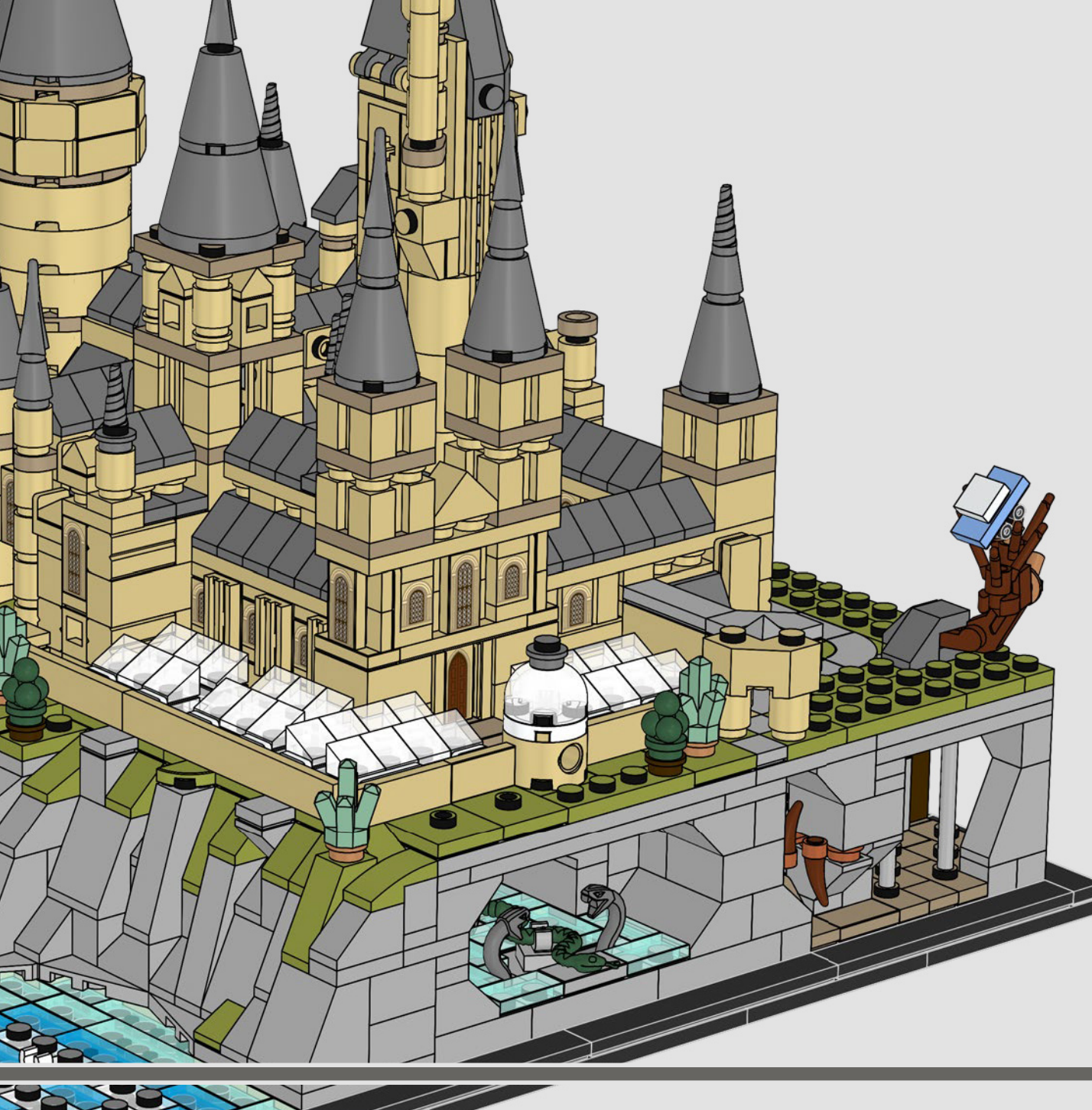

Le Saule cogneur a été planté pour permettre au Professeur Lupin de s'échapper en toute sécurité lorsque sortent les loups-garous les nuits de pleine lune. Il abrite un tunnel secret qui mène à la cabane hurlante, où Lupin se cache jusqu'à ce qu'il ait repris forme humaine.



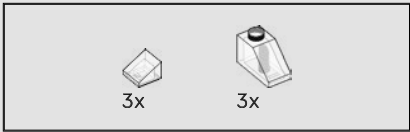

626

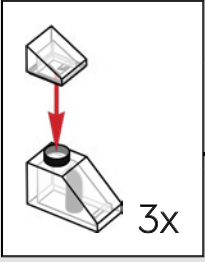
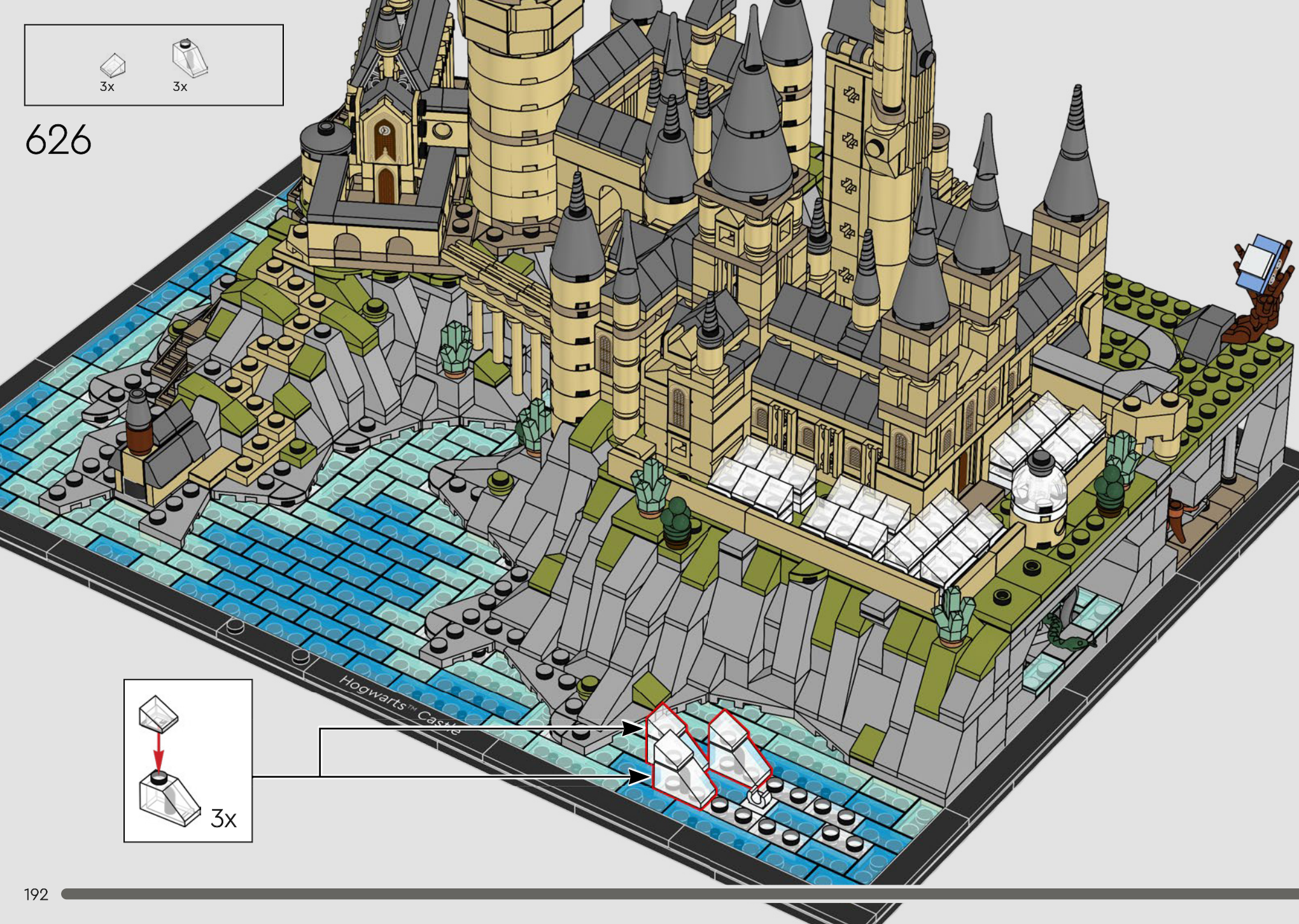



627

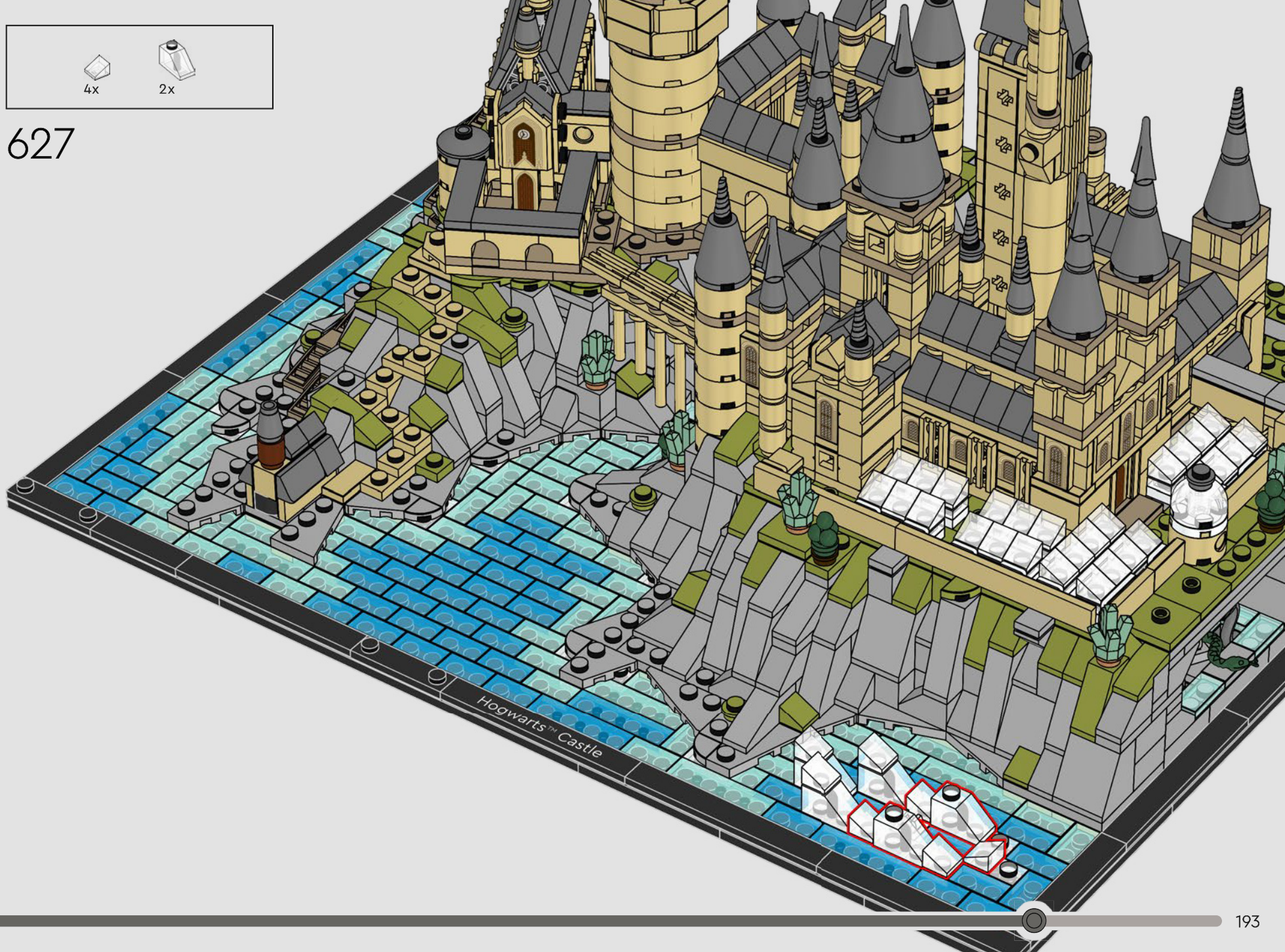

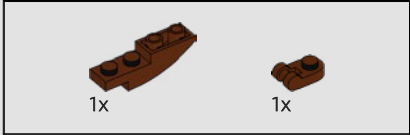
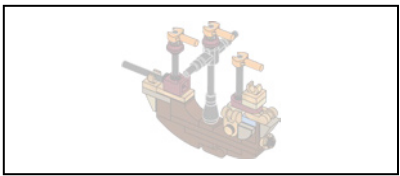

628

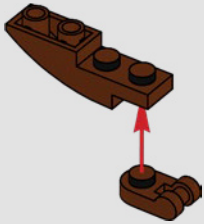

629

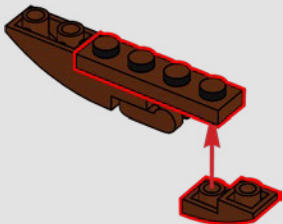

630

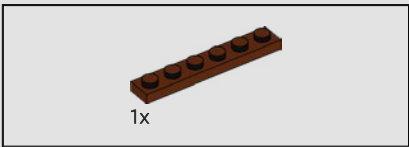
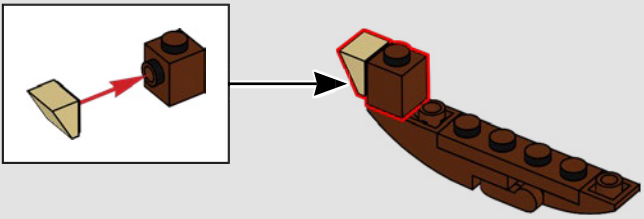

631

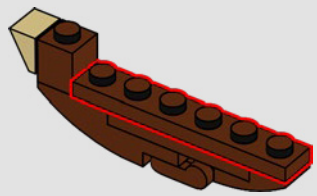

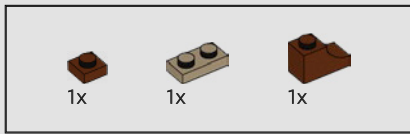

632

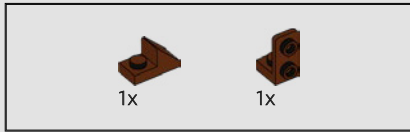
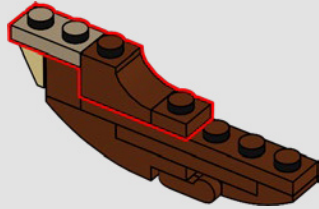

633

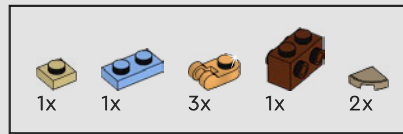
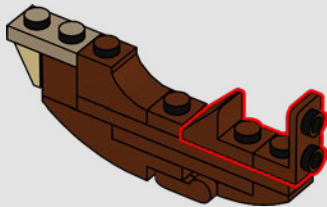

634

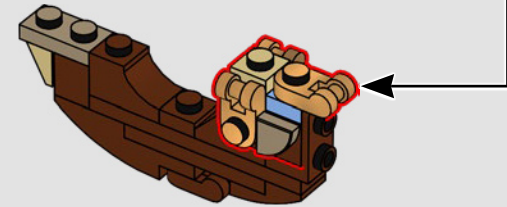
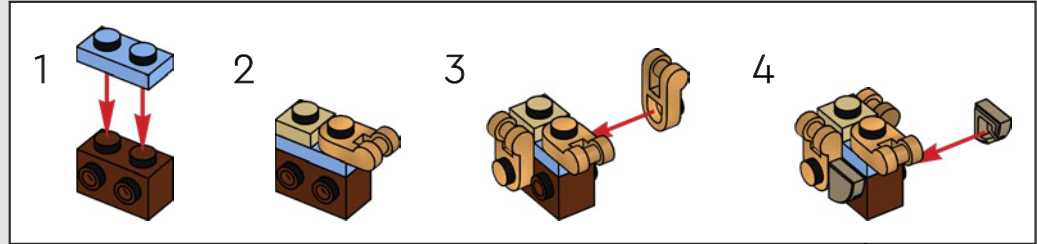

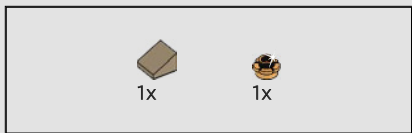

635

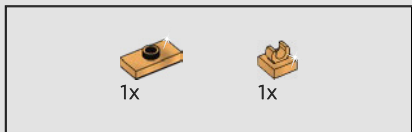
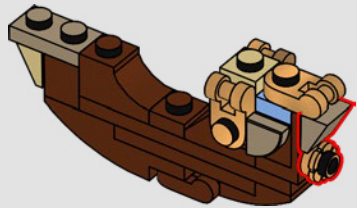

636

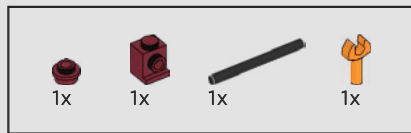
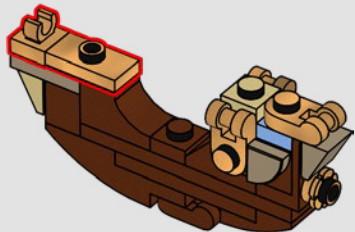

637

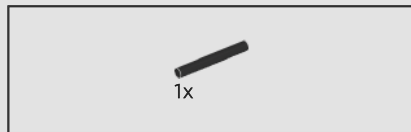
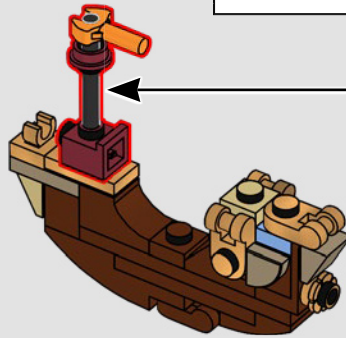
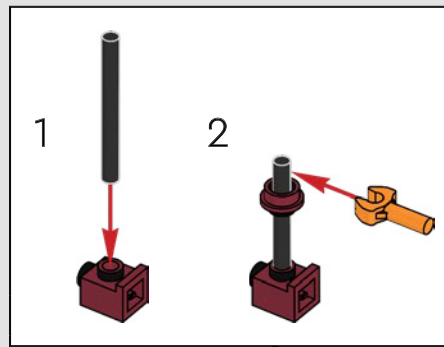

638

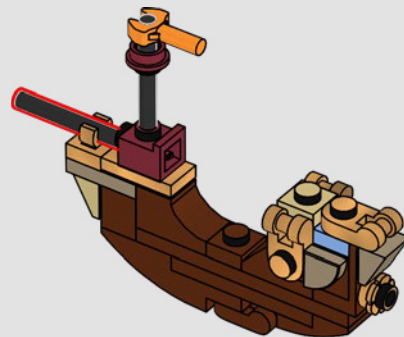

Le vaisseau magique de Durmstrang était utilisé pour se déplacer entre l'Institut Durmstrang et Poudlard pendant le Tournoi des Trois Sorciers. Mais vous êtes-vous déjà demandé comment le vaisseau faisait pour rejoindre le Lac noir depuis la mer du Nord ?

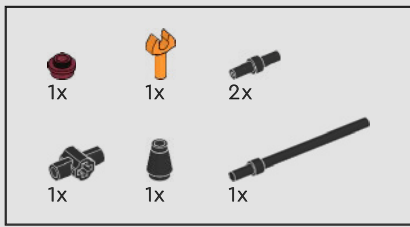

639

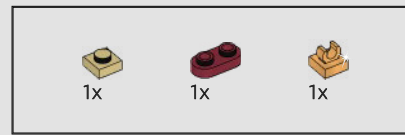
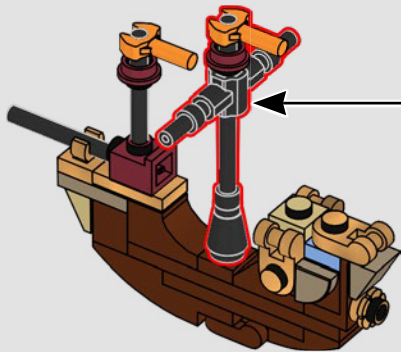
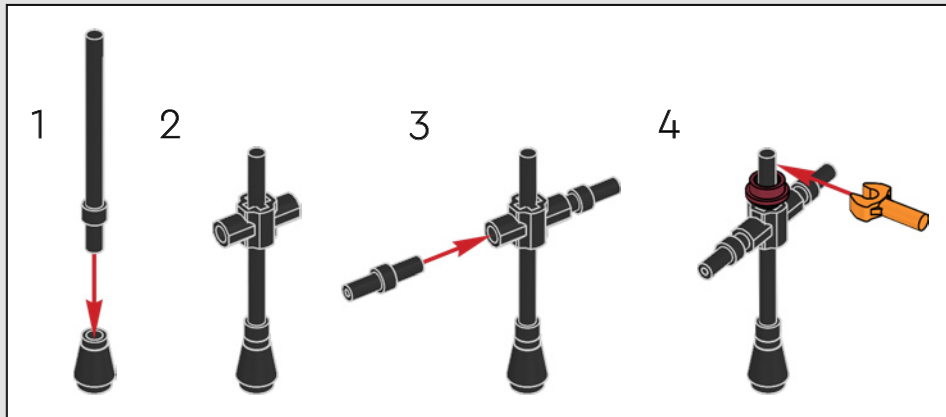

640

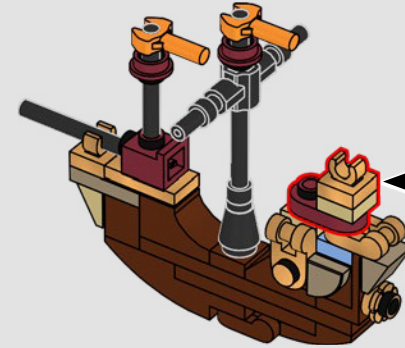
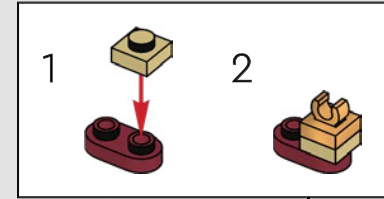

641

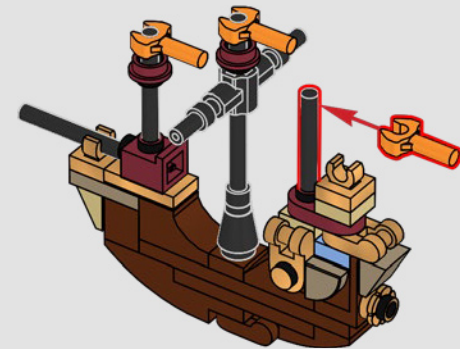



Hogwarts™ Castle

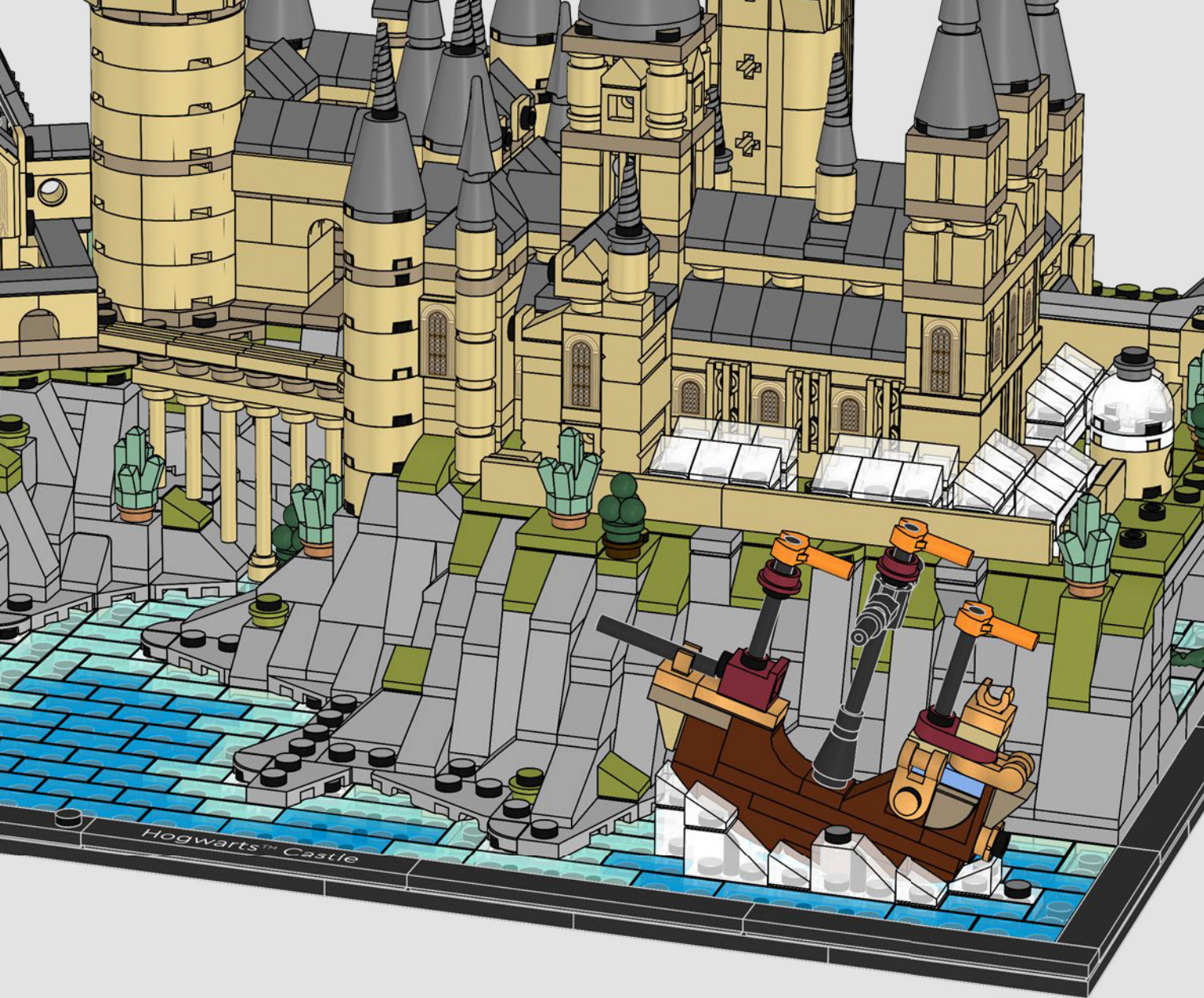

Le vaisseau de Durmstrang est arrivé jusqu'au lac par un raccourci enchanté créé entre le lac et d'autres plans d'eau – vraiment magique !

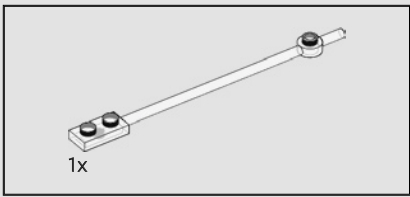

643

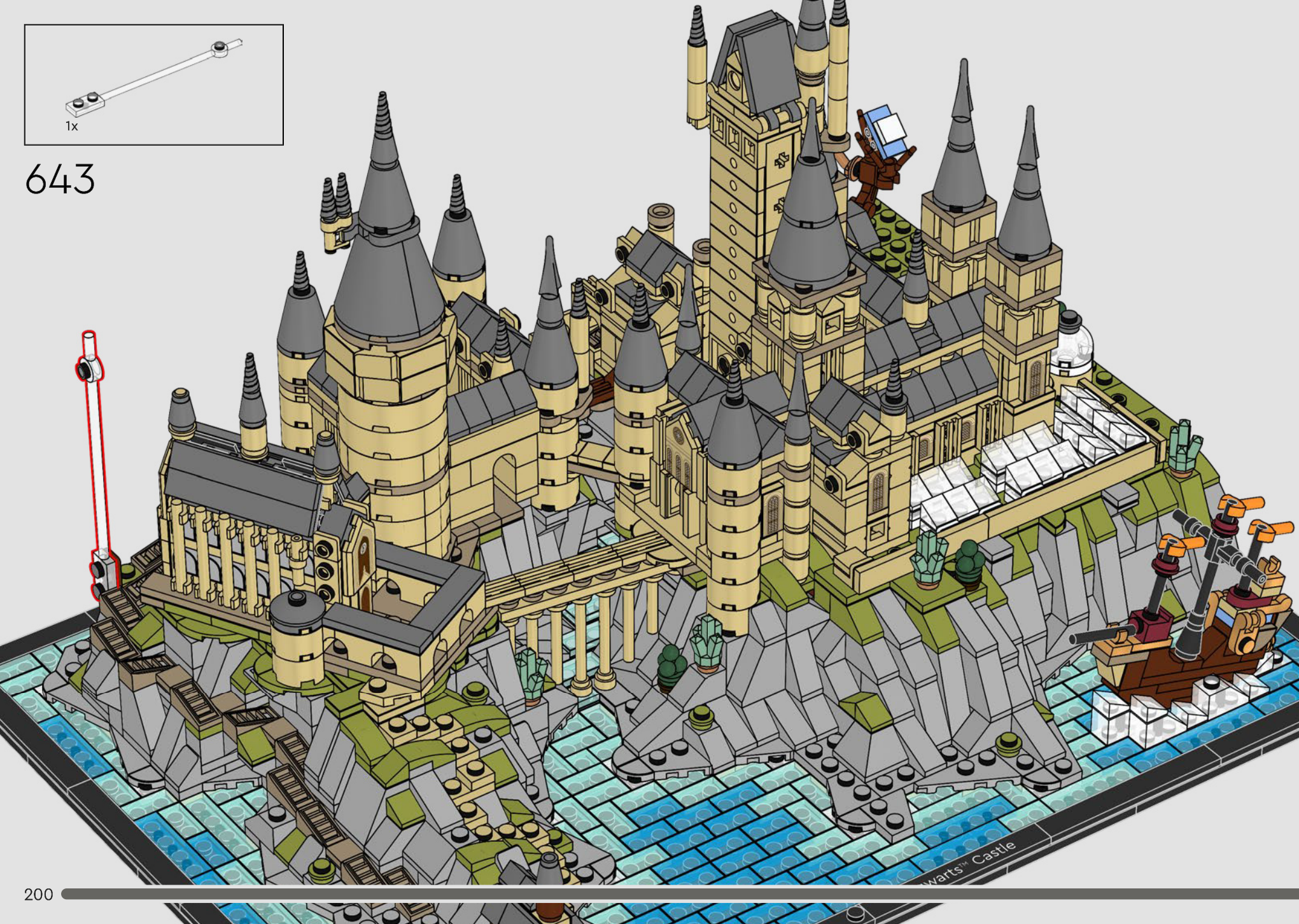

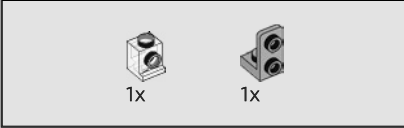

644

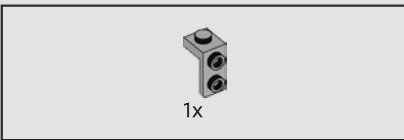
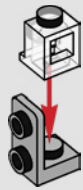

645



646

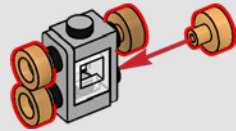



647

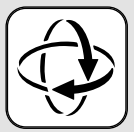
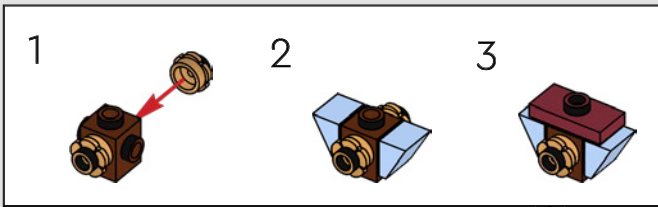

648

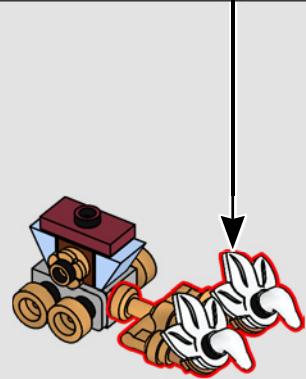
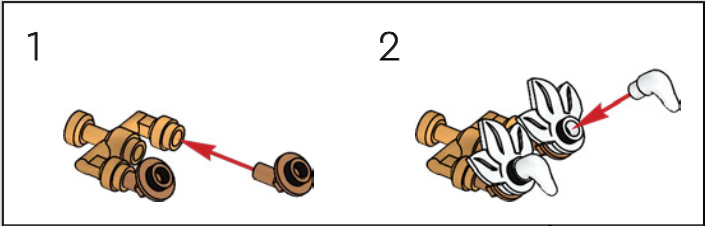

649

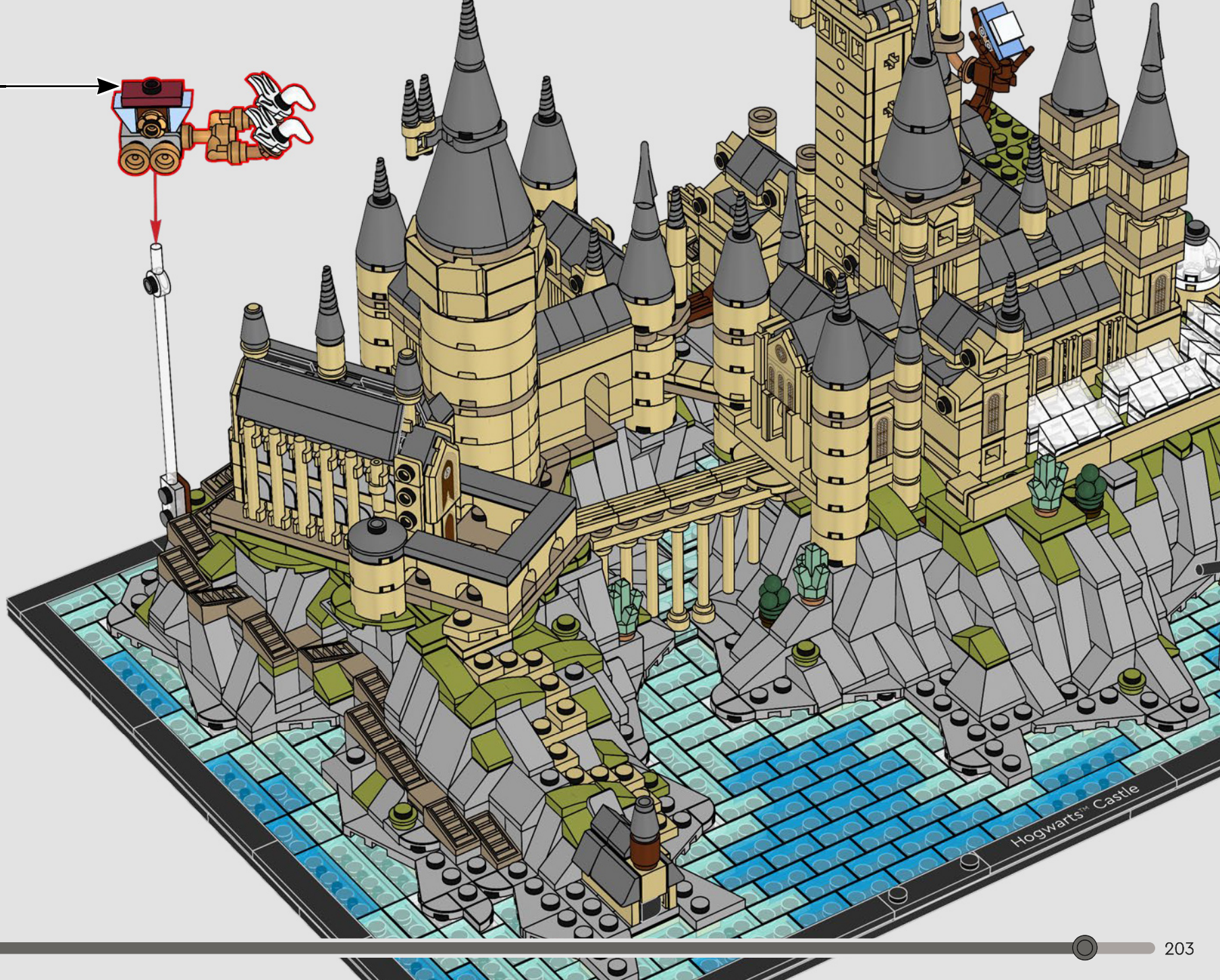

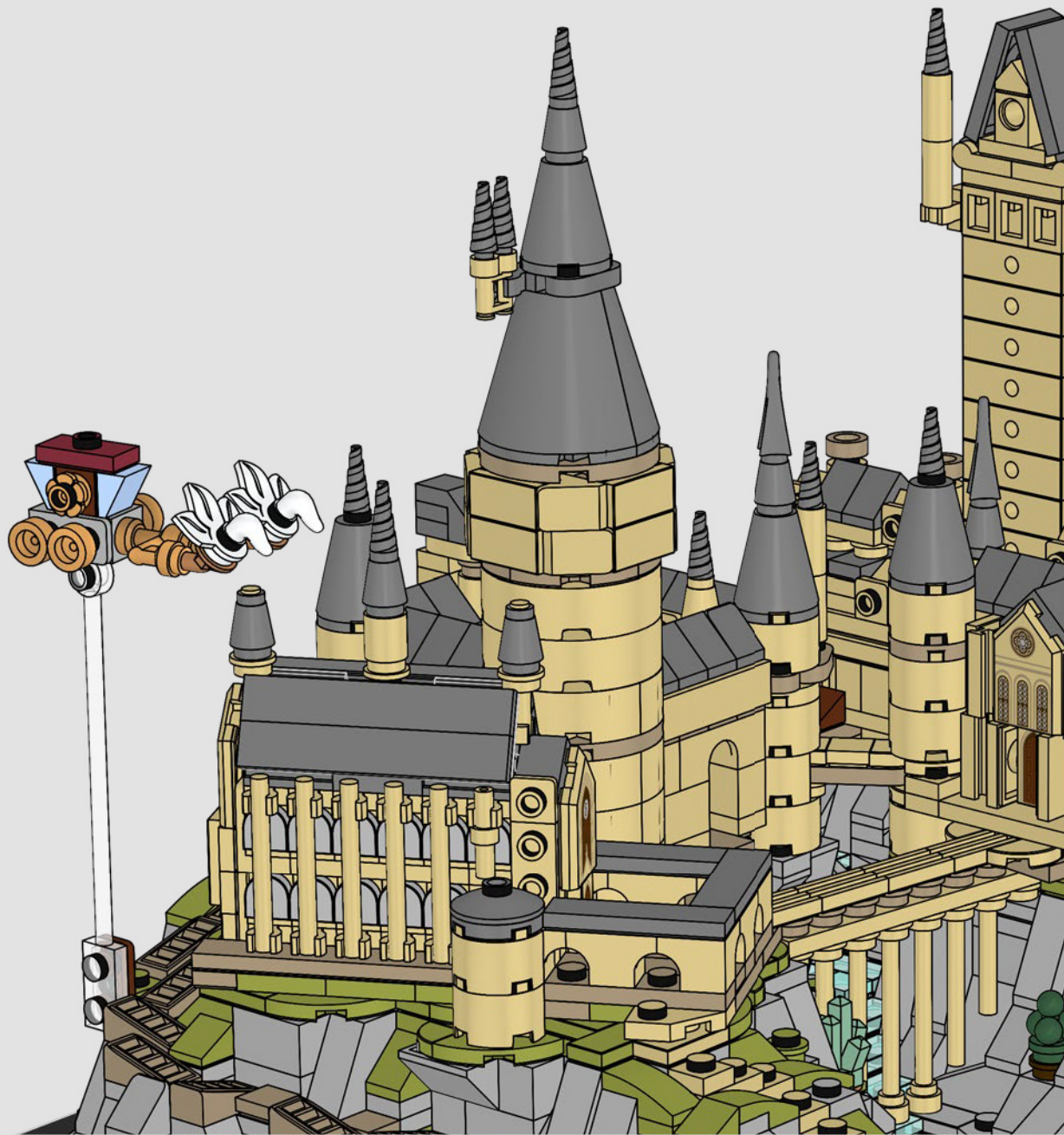

Le pégase du carrosse de Beauxbâtons est construit avec des éléments blancs de cornes et de feuilles LEGO®. Vous avez vu les rênes ? En réalité, c'est un bougeoir qui a été transformé comme par magie !

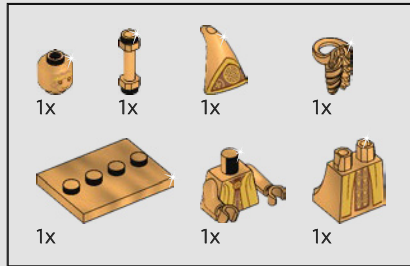

650

1

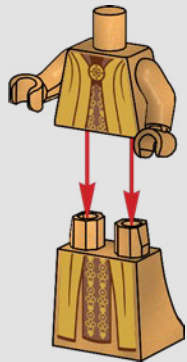

2

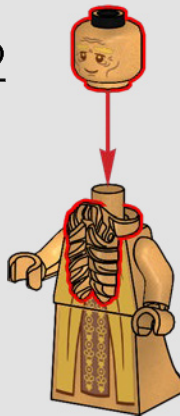

3

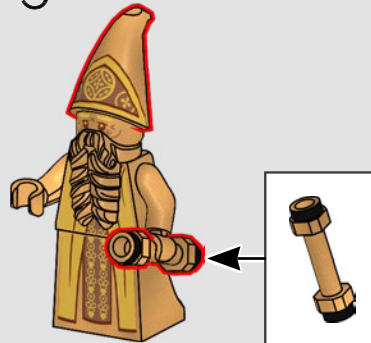

4



La minifigurine de l'architecte du château de Poudlard a été créée en exclusivité pour ce set. Elle possède une barbe et tient dans sa main un modèle de Poudlard et un rouleau de papier représentant un plan de l'école.

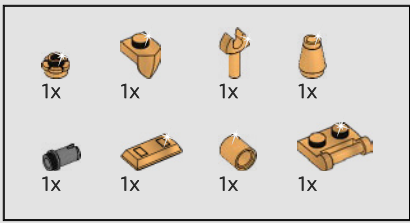

651

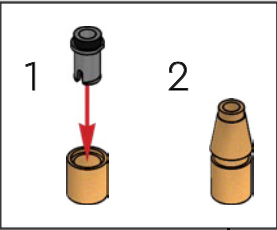

1

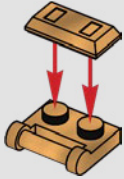

2

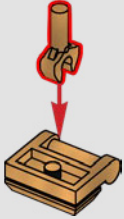

3

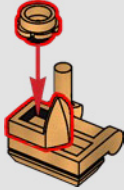

4





L'architecte du château de Poudlard était en poste à la fin du X^e siècle. On ne sait pas grand-chose de sa vie ou ses autres œuvres.





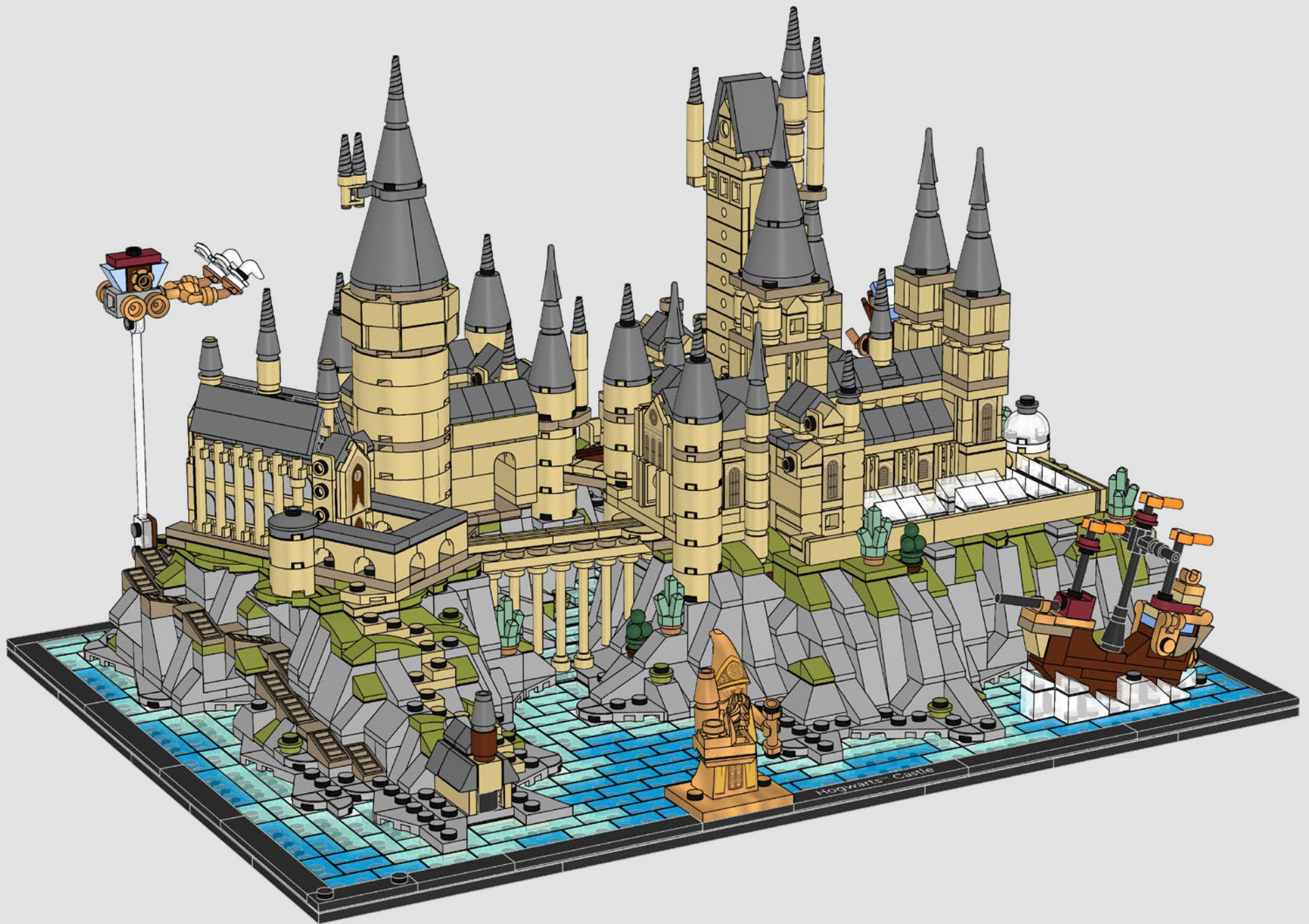

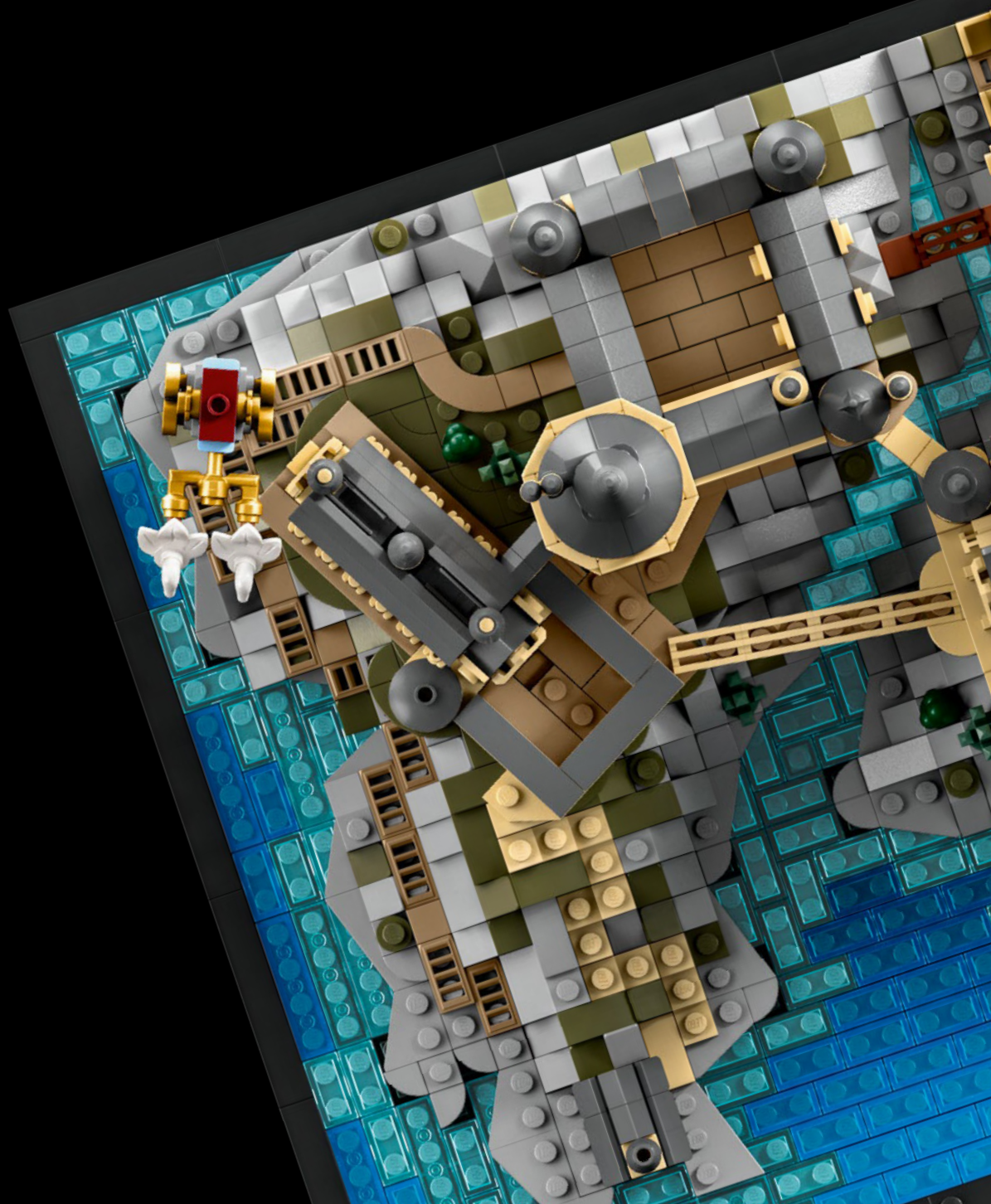

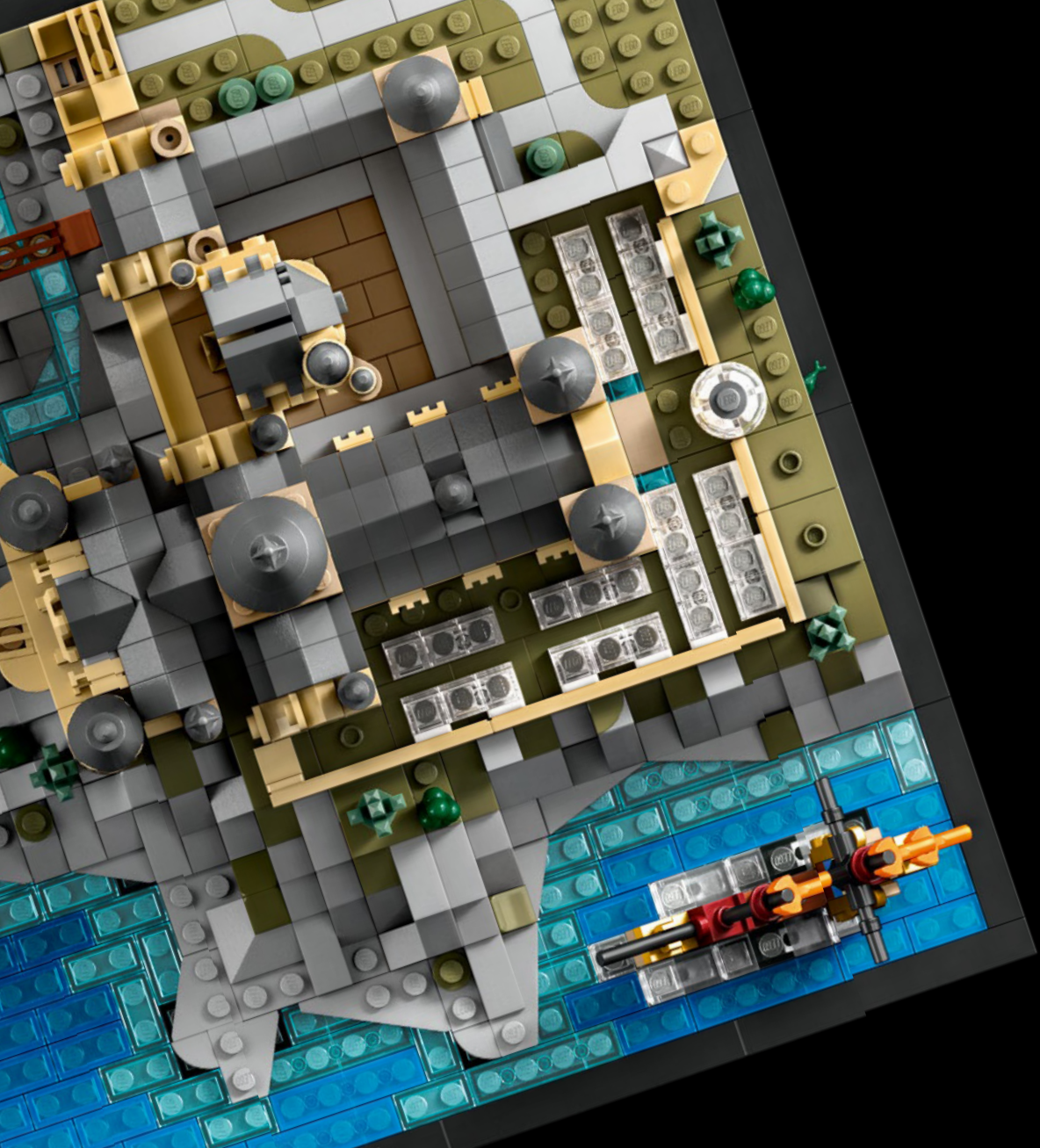

Hogwarts™ Castle



- 2x 614101
- 2x 6186681
- 2x 6328195
- 5x 307001
- 9x 302401
- 1x 6348055
- 8x 6242241
- 2x 4111971
- 2x 6382783
- 1x 6044691
- 1x 403201
- 1x 4667575
- 7x 302301
- 1x 6070698
- 3x 362301
- 11x 6195371
- 1x 4550745
- 1x 246501
- 3x 300201
- 2x 371001
- 2x 300101
- 1x 6222425
- 1x 366601
- 7x 6454936
- 27x 4117070
- 3x 4529237
- 63x 4161734
- 11x 6443061
- 2x 6353196
- 1x 4569547
- 1x 6167923
- 1x 4213568
- 1x 4224793
- 1x 6360037
- 1x 6454941
- 2x 6212758
- 5x 6351413
- 2x 6408047
- 1x 6447501
- 1x 6262018
- 1x 4624086
- 2x 4140562
- 2x 4579260
- 2x 4179771
- 4x 6175968
- 17x 6365720
- 3x 6374151
- 1x 6374192
- 1x 4213568
- 1x 4224793
- 1x 6360037
- 1x 6454941
- 2x 6212758
- 5x 6351413
- 2x 6408047
- 1x 6447501
- 1x 6262018
- 1x 4624086
- 2x 4140562
- 2x 4579260
- 2x 4179771
- 4x 6175968
- 17x 6365720
- 3x 6374151
- 6x 6236425
- 40x 4113917
- 34x 4114026
- 9x 6148262
- 43x 6092587
- 36x 4124456
- 10x 6455327
- 3x 6236914
- 8x 6069165
- 4x 4109995
- 1x 6024495
- 1x 6214334
- 2x 4159279
- 5x 6236423
- 1x 6445058
- 3x 6455326
- 10x 6391523
- 9x 6219794
- 2x 6103001
- 1x 4205107
- 7x 6174925
- 1x 6313611
- 1x 6117975
- 1x 6249809
- 2x 6253003
- 4x 4160483
- 1x 6374166
- 2x 4217562
- 5x 6443062
- 2x 4124455
- 6x 4114077
- 6x 4114306
- 2x 6221467
- 5x 6454937
- 16x 4114084
- 4x 4185177
- 1x 4188866
- 1x 6148265
- 12x 6055868
- 1x 6469454
- 1x 6458487
- 1x 6454439
- 11x 4121921
- 6x 6131896
- 2x 4162465
- 7x 4618651
- 1x 6058093
- 4x 6211966
- 9x 6410762
- 1x 6245271
- 1x 4543858
- 12x 6116614
- 9x 4118790
- 4x 4159739
- 2x 6175367
- 10x 4113233
- 5x 6232136
- 7x 6257600
- 5x 4550324
- 23x 6352222
- 2x 4113916
- 1x 6213676
- 2x 6294592
- 4x 6115031
- 2x 6454935
- 10x 4114309
- 1x 6351905
- 7x 4124067
- 6x 4112982
- 1x 4157277
- 3x 4243824
- 1x 6383728
- 7x 4113993
- 2x 4181134
- 4x 4114324
- 2x 4159774
- 1x 4544139
- 4x 4114001
- 4x 4113988
- 1x 6075179
- 1x 4624185
- 2x 447721
- 2x 611121
- 4x 614121
- 2x 362221
- 1x 302121
- 5x 371021
- 2x 6372124
- 4x 6315780
- 1x 6347604
- 5x 242023
- 5x 301023
- 2x 366623
- 17x 614124
- 6x 362224
- 3x 362324
- 1x 4188313
- 1x 6457333
- 1x 6350055
- 1x 6454443
- 3x 6212377
- 1x 6207933
- 1x 6092594
- 1x 6326425
- 1x 6454437
- 1x 4585493
- 1x 6378168
- 4x 6209691
- 1x 4529247
- 1x 6186672
- 1x 6453281
- 1x 6454435
- 1x 6256803
- 2x 6262138
- 1x 6415995
- 1x 6083975

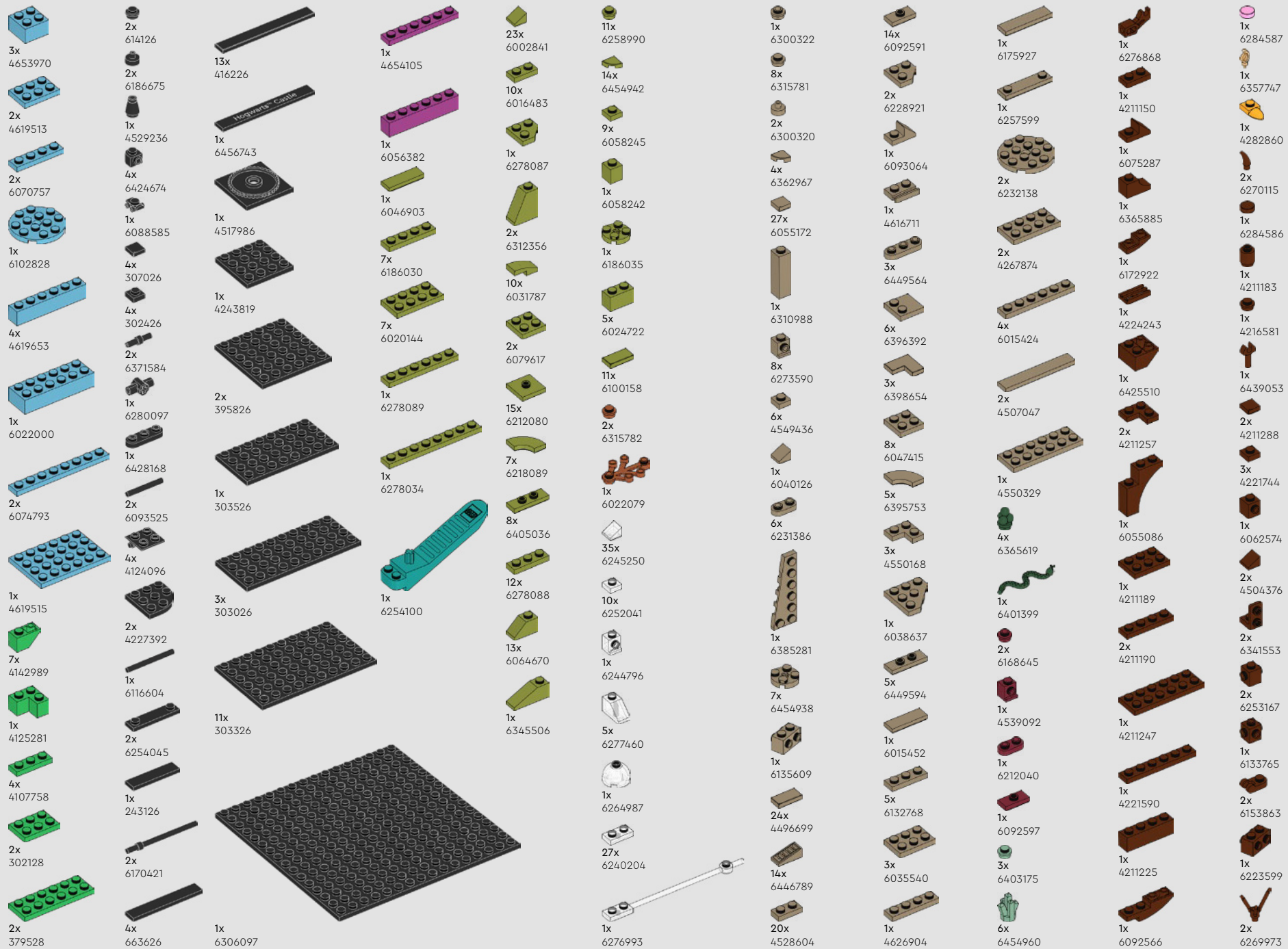

- 1x 4210763
- 2x 6168776
- 4x 4211066
- 2x 6331866
- 3x 4211094
- 1x 6126083
- 1x 6201630
- 10x 6092666
- 1x 6115080
- 1x 4211010
- 2x 6174938
- 17x 6445056
- 6x 6269969
- 15x 4529240
- 2x 6331689
- 1x 4210867
- 2x 4211100
- 8x 4210719
- 1x 4243831
- 1x 6186635
- 2x 4211103
- 3x 6231765
- 2x 4210633
- 1x 6431826
- 3x 6395635
- 4x 6454438
- 1x 4211098
- 5x 6343852
- 4x 4210651
- 4x 6262021
- 2x 4504378
- 2x 6234583
- 2x 6235153
- 7x 6167641
- 4x 6400315
- 51x 6251289
- 8x 6252050
- 1x 4179825
- 1x 6092601
- 1x 6221607
- 1x 6296892
- 45x 4226221
- 3x 4567887
- 14x 4211135
- 1x 4211088
- 3x 6069164
- 2x 6092572
- 3x 4211053
- 1x 4211105
- 1x 4529241
- 1x 6284071
- 3x 6448793
- 21x 6250597
- 1x 6455328
- 5x 4521921
- 23x 4211389
- 5x 6362975
- 12x 6176433
- 3x 6345639
- 2x 6433942
- 12x 6163478
- 6x 4211415
- 2x 4211489
- 1x 4526932
- 9x 4211394
- 1x 6420741
- 6x 4211791
- 5x 4211794
- 1x 6234738
- 18x 4211399
- 1x 6225242
- 46x 4211614
- 1x 6347715
- 3x 6258381
- 2x 4568637
- 2x 6075075
- 15x 4211488
- 2x 6211969
- 12x 4211428
- 7x 6116608
- 4x 6066097
- 5x 6186657
- 1x 4216248
- 3x 6308012
- 4x 6065824
- 1x 4651063
- 1x 6469440
- 1x 6269049
- 40x 4515374
- 12x 4211437
- 20x 4211388
- 6x 4657459
- 2x 4211773
- 10x 4211445
- 13x 6093859
- 11x 4211494
- 46x 4211398
- 9x 4211414
- 2x 6170387
- 1x 4211564
- 2x 6123809
- 5x 4234535
- 8x 4211353
- 2x 4211410
- 1x 6163990
- 11x 4211396
- 2x 4211356
- 1x 6213378
- 13x 6435857
- 14x 4211349
- 11x 4211387
- 1x 4216250
- 3x 4211397
- 1x 6177078
- 1x 6126082
- 18x 4211429
- 8x 4211386
- 2x 6435930
- 1x 6306729
- 4x 6163477
- 1x 4645397
- 3x 4558169
- 1x 6075066
- 3x 4211438
- 2x 4211393
- 1x 4618874
- 2x 4243797
- 2x 4211549
- 1x 6015347
- 7x 4211385
- 2x 4211395
- 1x 6372029
- 1x 4211392
- 6x 4211404
- 1x 6037399
- 1x 4211474
- 3x 4251149
- 2x 4211521
- 2x 4211407
- 3x 6059033
- 3x 4211452
- 1x 4211795
- 2x 4211425
- 6x 4157103
- 3x 6439042
- 3x 4173805
- 16x 4121739
- 17x 4220634
- 23x 4164037
- 10x 6254256
- 85x 6251295
- 3x 6343877
- 11x 6252049
- 1x 4211522
- 1x 4211402
- 1x 4211405



 [LEGO.com/service](https://www.LEGO.com/service)



YOU COULD WIN



YOU COULD WIN

Your feedback will help shape the future development of this product series.

Visit:

DU KÖNNTEST GEWINNEN

Dein Feedback trägt zur Weiterentwicklung dieser Produktreihe bei.

Geh auf:

VOUS POURRIEZ GAGNER

Vos commentaires nous aideront à concevoir les futurs produits de cette gamme.

Visitez :

POTRESTI VINCERE TU

La tua opinione ci aiuterà a migliorare la creazione futura di questa linea di prodotti.

Visita:

PUEDES GANAR

Tu opinión contribuirá al futuro de esta serie de productos.

Visita:

轻松获奖

您的反馈将有助于我们在今后改进本产品系列。

请访问:

LEGO.com/productfeedback

You also have the chance to win a LEGO® set.

Terms and conditions apply.*

Außerdem hast du die Chance, ein LEGO® Set zu gewinnen.

Es gelten die Teilnahmebedingungen.*

Vous pourriez également gagner un ensemble LEGO®.

Des conditions s'appliquent.*

Hai anche la possibilità di vincere un set LEGO®.

Termini e condizioni sono applicabili.*

También tienes la oportunidad de ganar un set LEGO®.

Aplican términos y condiciones.*

您还有机会赢取乐高®套装。

条款和条件适用。*

*LEGO.com/productfeedback-terms

II

LEGO and the LEGO logo are trademarks of the LEGO Group. ©2023 The LEGO Group.

WIZARDING WORLD and all related trademarks, characters, names, and indicia are
© & ™ Warner Bros. Entertainment Inc. Publishing Rights © JKR. (s23)